

# BUNGARD

BEL

2024/2025 English

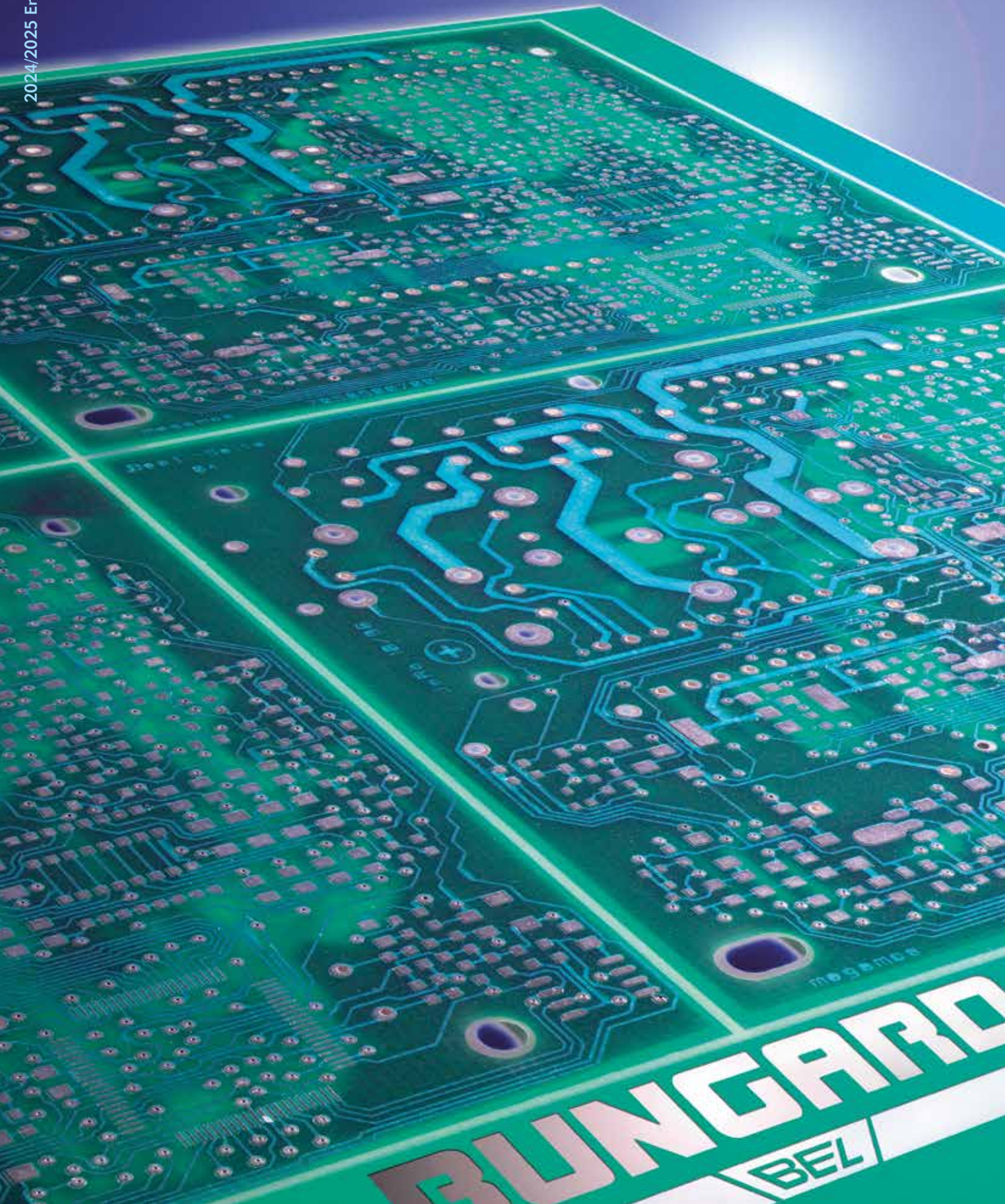

# BUNGARD

BEL

# CONTENTS

**Workflow**  
**Original Bungard**  
  
**ALUCOREX**  
**SMD Stencils**  
**NE-CUT**  
**StenPrint 3000**  
**Filmstar-PLUS**  
**UV-Laser Direct**  
**Hellas LED**  
**EXP 3040 LED**  
**Jet 34d**  
**Splash**  
**Splash Center**  
**DL 500**  
**Titan 3500**  
**Sprint 3000**  
**AquaPur 1000**  
**Ionex**  
**PCB-Lab**  
**Favorit**  
**Variodril**  
**Solide carbide**  
**Etching or milling**



**Baseline or Profiline**  
Page 4-5  
**Presensitized boards**  
Page 6-7  
**Special boards**  
Page 8  
**FR4 thin laminate**  
Page 8  
**Cothem**  
Page 9  
**Presensitized aluminium**  
Page 9  
**For solder paste application**  
Page 10  
**Board cutter**  
Page 10  
**Stencil Printer**  
Page 11  
**Photoplotter**  
Page 12  
**Laser direct imaging**  
Page 13  
**Double sided vacuum exposure unit**  
Page 14  
**Parallel beam exposure units**  
Page 15  
**Spray etching machine**  
Page 16  
**Spray etching machine**  
Page 17  
**Spray etching machine**  
Page 18  
**Conveyorised spray etching machine**  
Page 19-21  
**Rotation spray etching machine**  
Page 22-23  
**Conveyorised spray etching machine**  
Page 24-25  
**Waste water treatment system**  
Page 25  
**Waste water treatment system**  
Page 26-27  
**Lab accessories**  
Page 28  
**Through-Hole plating**  
Page 29  
**PCB drilling machine**  
Page 30  
**Drills and routers**  
Page 31  
**Comparison**  
Page 32-33

# CONTENTS

**Bungard CCD**  
  
**RoutePro 3000 / CCD Options**  
**QualityScan 3000**  
**IsoCam**  
**Compacta 30**  
**Compacta 40 2 CU**  
**Multi-Coater**  
**HitecPlate 3040**  
**Protec 2030 + 3040**  
**RLM 419p**  
**RBM 300**  
**RBM 402 KF**  
**AIR 2000 / ULX 110**  
**RDC 15 / RDC 21-K**  
**RDC 30 Multidip / Multi-Coater**  
**SMT 3000**  
**HotAir 06**  
**SMT 3000 ECO Basis**  
**Print Star 3000 / HotAir 3000**  
**RMP**  
**Bungard**



**Overview CNC machines**  
Page 34-35  
**CCD/2**  
Page 36-43  
**CCD**  
Page 44-47  
**CCD/XL**  
Page 48-51  
**CCD/Premium**  
Page 52-53  
**Accessories**  
Page 54-55  
**CNC Software / Modules**  
Page 56-61  
**Process control**  
Page 62-63  
**CNC Software**  
Page 64-65  
**Through-Hole plating line**  
Page 66  
**Through-Hole plating line**  
Page 67  
**Through-Hole plating line**  
Page 67  
**Through-Hole plating line**  
Page 68  
**Surface treatment**  
Page 69  
**Dry film Laminator**  
Page 69  
**Brushing machine**  
Page 70  
**Brushing machine**  
Page 71  
**Conveyorized PCB dryer / Oven**  
Page 72  
**Dip coaters**  
Page 73  
**Dip coaters**  
Page 74-75  
**Pick&Place**  
Page 76  
**Reflow Oven**  
Page 77  
**Manuel Pick&Place**  
Page 78  
**Stencil Printer / Reflow Oven**  
Page 79  
**Multilayer press**  
Page 80-81  
**Worldwide**  
Page 82-83

# WORKFLOW

## Professional PCB production including galvanic PTH

### BASISLINE

- raw material cut to size (Ne-Cut)
- ↓
- CNC-drilling (BUNGARD CCD/2)
- ↓
- brush cleaning (RBM 300)
- ↓
- galvanic PTH (Compacta 30)
- ↓
- brush cleaning (RBM 300)
- ↓
- lamination of etch resist (RLM 419p)

film production with Bungard Filmstar

- ↓
- vacuum exposure (Hellas LED)
- ↓
- spray developing (Splash / Jet 34D)
- ↓
- spray etching stripping of etch resist (Splash Center)
- ↓
- brush cleaning (RBM 300)
- ↓
- electroless tin (SUR-TIN)
- ↓
- lamination of solder mask (RLM 419p)
- ↓
- exposure of solder mask (Hellas LED)
- ↓
- spray developing (Splash / Jet 34D)
- ↓
- curing of solder mask (Hellas LED or hot air oven)
- ↓
- CNC-V-cut or CNC-routing (Bungard CCD/2)

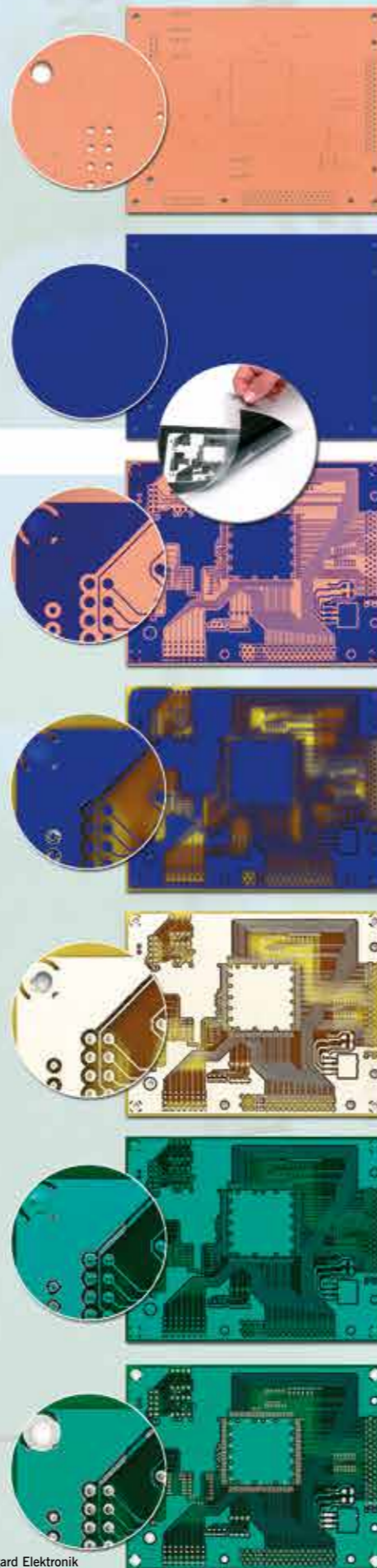

## solder mask... Components printing... upgradeable to multilayer

### PROFILINE

- raw material cut to size (Ne-Cut)
- ↓
- CNC-drilling (BUNGARD CCD)
- ↓
- brush cleaning (RBM 402 KF)
- ↓
- galvanic PTH (Compacta 40)
- ↓
- brush cleaning (RBM 402 KF)
- ↓
- lamination of etch resist (RLM 419p)

film production with Bungard Filmstar

- ↓
- vacuum exposure (EXP 3040 LED)
- ↓
- spray developing (DL 500)
- ↓
- spray etching stripping of etch resist (DL 500)
- ↓
- brush cleaning (RBM 402 KF)
- ↓
- electroless tin (SUR-TIN)
- ↓
- lamination of solder mask (RLM 419p)
- ↓
- exposure of solder mask (EXP 3040 LED)
- ↓
- spray developing (DL 500)
- ↓
- curing of solder mask (EXP 3040 LED)
- ↓
- CNC-V-cut or CNC-routing (Bungard CCD)



Bungard Line Proposals

Sample Components printing

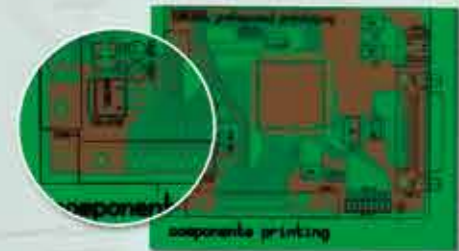

Sample outside multilayer

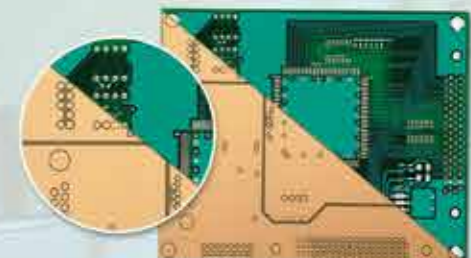

inside multilayer

# ORIGINAL BUNGARD

## PRESENSITIZED BOARD

The name **ORIGINAL BUNGARD** stands for highest quality and processing safety of pre-sensitized laminates. Like no other comparable product, this material allows a fast, flexible and faultless production of PCBs in small series and prototypes.

We use first-choice laminates approved and certified by UL, NEMA, DIN, IEC and others.

Several types of laminates, i.e. FR2, FR3, CEM1, and FR4 are available in thicknesses of 0.5, 0.8, 1.0, 1.6, 2.0 and 2.5 mm with either 18, 35 or 70 microns copper. The max. panel size is 510 x 1150 mm. Our cutting service provides sheets down to 50 x 50 mm min. size, with an accuracy of 0.1 mm.

## PHOTORESIST

We coat the laminates with a special positive working liquid resist made according to our own recipe. The resist features highest exposure sensitivity, short processing turns and large processing latitude. The equal and dust-free coating has a defined thickness of 5 µm. The maximum spectral response is in the range of 350 - 400 nm. The line resolution is limited only by the type of exposure unit. Typical exposure times are 90 seconds on a set with fluorescent neon tubes. The resist allows multiple exposure.

Referring to our special developer, at 20 °C the developing time is less than 45 seconds. On the other hand, the resist is absolutely stable for more than 5 minutes in the developer. It is resistant to acid etching or galvanic chemicals and even permits alkaline etching at a pH-level less than 9.5.

The boards are protected against mechanical damage and unwanted exposure by a special, blue coloured adhesive foil. Due to this protective foil, no flitters appear when cutting or milling the boards.

Each board is subjected to chemical and physical controls and tests before and after coating.

A shelf live of more than 1 year under normal storage conditions is guaranteed. Even 10 year old boards still work.

## PRE-SENSITIZING SERVICE

We can coat boards that you supply with photoresist. The max. board size is 530 x 1160 mm, the min. board thickness is 0.3 mm. Our pre-sensitizing service includes cleaning, double sided coating in dip technology, pre-aging, optical control and protection foil. Attention: dip rim 10mm on top and drip rim of 10 mm at the bottom will reduce usable size by 20 mm on the short side (530 mm will go down to 510 mm). The rim is on request removed without charge.

## BUNGARD NEGATIVE PHOTO-COATED BASE MATERIAL

As an alternative to our Bungard Positive Liquid Resist, you can also have all raw plate formats coated with a negative-developing tenting resist. In contrast to the liquid, approximately 5 µm thick positive resist, the negative resist is 35 µm thick and is laminated as a film and packaged in a light protection paper.

In this resist, the exposed areas are hardened by the light and remain on developing; The film template must therefore be created as a negative. The exposure time on the Bungard Hellas is approx. 25 s and after the exposure a color change from light blue to dark purple can be seen directly. You need special negative developer. Negative laminate is advantageous in longer etching processes (e.g., with thicker SMD stencils) because the resist will withstand the spray beam longer by the larger resist thickness. Disadvantage is the sensitivity and short shelf life. Order only the currently required need and process the plates as soon as possible and only in the yellow room condition.

We also distribute laminators and photoresists on roll for self-laminating.

## STANDARD CUTTINGS FR4

Format (mm)

1.5 mm 35 µm Cu	1.5 mm 70 µm Cu
210 x 300	210 x 300
200 x 250	200 x 250
150 x 250	150 x 250
160 x 233.4	160 x 233.4
150 x 200	150 x 200
125 x 175	125 x 175
100 x 160	100 x 160
75 x 100	75 x 100

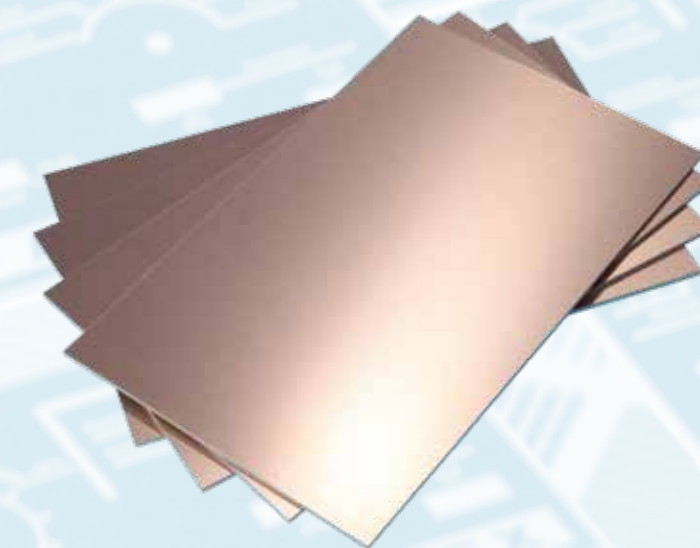

## PANELS FR4

Format (mm)

0.5 - 1.5 mm 18 µm Cu	0.5 - 2.5 mm 35 µm Cu	0.5 - 2.5 mm 70 µm Cu	1.5 mm 105 µm Cu	1.5 mm FR4 blue/black 35 µm
510 x 1150 x 0.5	510 x 1150 x 0.5	510 x 1150 x 0.5	510 x 1150 x 1.5	510 x 1150 x 1.5
510 x 570 x 0.5	510 x 570 x 0.5	510 x 570 x 0.5		
510 x 1150 x 0.8	510 x 1150 x 0.8	510 x 1150 x 0.8		
510 x 570 x 0.8	510 x 570 x 0.8	510 x 570 x 0.8		
510 x 1150 x 1.0	510 x 1150 x 1.0	510 x 1150 x 1.0		
510 x 570 x 1.0	510 x 570 x 1.0	510 x 570 x 1.0		
510 x 1150 x 1.5	510 x 1150 x 1.5	510 x 1150 x 1.5		
510 x 570 x 1.5	510 x 570 x 1.5	510 x 570 x 1.5		
	510 x 1150 x 2.0	510 x 1150 x 2.0		
	510 x 570 x 2.0	510 x 570 x 2.0		
	510 x 1150 x 2.5	510 x 1150 x 2.5		
	510 x 570 x 2.5	510 x 570 x 2.5		

## PANELS FR2

Format 480 x 1000 x 1.5 mm  
35 µm Cu single or double sided

## PANELS FR3

Format 510 x 1150 x 1.5 mm  
35 µm Cu double sided

## PANELS CEM1

Format 510 x 1150 x 1.5 mm  
35 µm single sided

## CUTTING SERVICE

We cut down all boards to non-standard sizes on request. The maximum board size is 510 x 1150 mm, the minimum size is 50 x 50 mm. Remains will be included. Boards >= 2 mm will be cut by saw. Saw cutting loss will be 3 mm per piece.

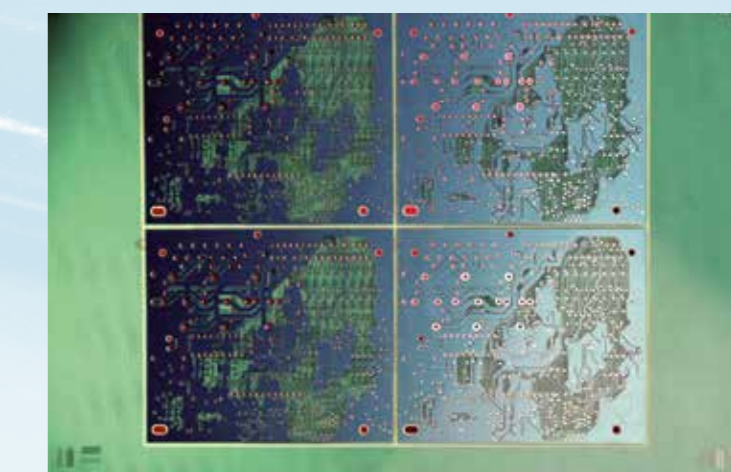
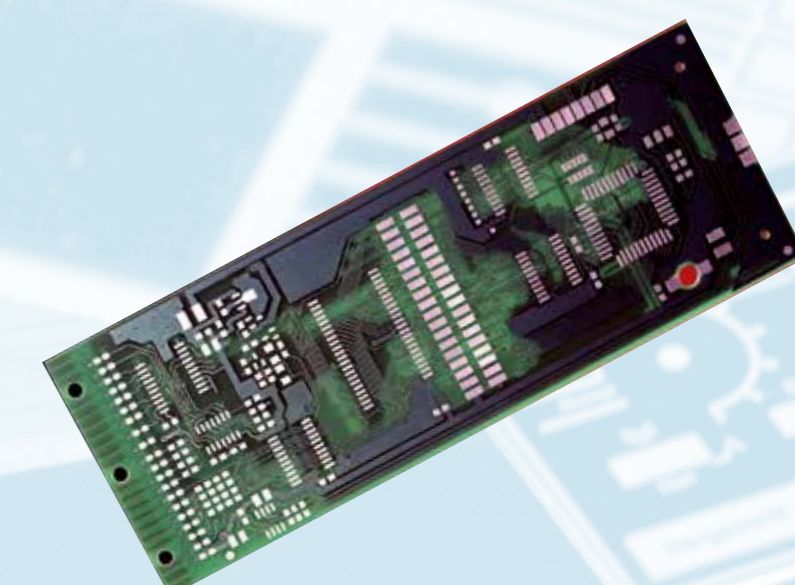

## SPECIAL PURPOSE LAMINATES

Besides our ORIGINAL BUNGARD fotopositive coated base material we offer a wide range of laminates related to pcb manufacturing.

### Engraving plates

for Front Panel Engraving. Size approx. 500 x 1000 x 1.5 mm. Black and nature available.

### Technical glass fibre laminate

no copper clad, no photoresist, size: 510 x 1150 x 1.55 mm

### Drill backing boards

Drill backing boards for drilling pcbs e.g. with the BUNGARD CCD.

in stock: 500 x 1000 x 2.5 mm

500 x 1000 x 6 mm

245 x 330 x 6 mm

### Multilayer production

Prepregs (250 x 350 x 0.2 mm)

outer layer (FR4 250 x 350 x 0.3 mm 18/00)

inner layer (FR4 250 x 350 x 0.5 mm 18/18)

separation foil

(packing size for Prepregs and separation foil 50 pcs. each)

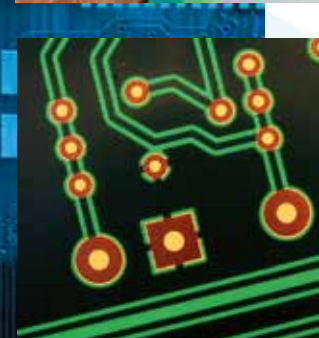
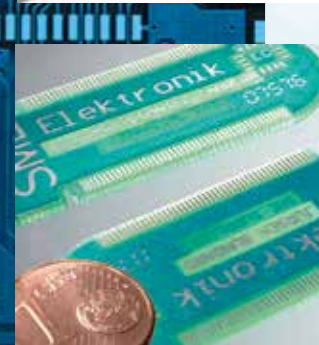

## FR4 THIN LAMINATE

in 0.125 mm and 0.2 mm thickness

For semiflex application and multilayer!

The Bungard semiflex base material combines the advantages of the simple processing of the Bungard standard base material with flexibility for special applications.

### Board formats:

100 x 160 mm 35 µm Cu

210 x 300 mm 35 µm Cu

510 x 1150 mm 35 µm Cu

## Copper clad laminates

FR4, CEM1, FR2, without photoresist. Approvals and standards as for presensitized boards.

The copper surface is not yet brushed.

### FR4, panel size 510 x 1150 mm,

- Thickness 0.5 mm; Copper clad 18 µm, 35 µm and 70 µm; single or double sided
- Thickness 0.8 mm; Copper clad 18 µm and 35 µm; single or double sided
- Thickness 1.5 mm; Copper clad 5 µm; single sided; Copper clad 18 µm, 35 µm, 70 µm and 105 µm; single or double sided
- Thickness 2.0 mm; Copper clad 35 µm and 70 µm; single or double sided
- Thickness 2.5 mm; Copper clad 35 µm and 70 µm; single or double sided

### CEM1

panel size 510 x 1150 mm, Thickness 1.5 mm Copper clad 35 µm single sided

### FR2

panel size 500 x 1000 mm, Thickness 1.5 mm Copper clad 35 µm single sided or double sided.

FR2 is perfect for isolation milling, because routers and drills will last much longer.

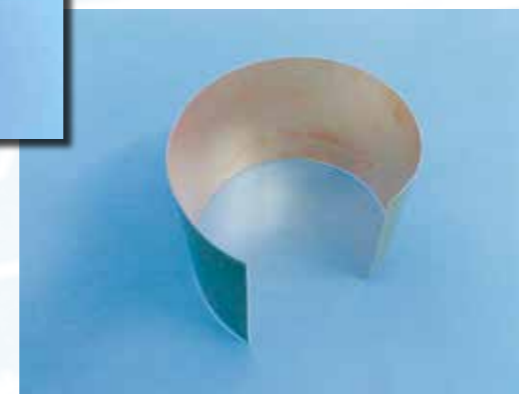

Please note that we sell boards of 100x160 only in units of 35 and 210x300 only in units of 8 boards.

## BUNGARD COTHERM:

For many applications customers demand a better thermal dissipation. One possible solution for heat problems are so called metal core boards, which consists of a 35 µm copper layer, a 100 µm isolation layer (FR4) and a 1000-2000 µm Aluminium layer.

Bungard offers this PCB type with brand name Cotherm. Cotherm is available with or without photosensitive resist and in these formats:

### Metal core board:

**Cotherm 1000/100/35 µm;**  
Format 530 x 1150 mm (1,0 mm; 1 x 35 CU)

**Cotherm 1500/100/35 µm;**  
Format 530 x 1150 mm (1,5 mm; 1 x 35 CU)

**Cotherm 2000/100/35 µm;**  
Format 530 x 1150 mm (2,0 mm 1 x 35 CU)

Cotherm can be processed like normal base material. Please note, that the isolation layer is very thin. With unskilled mechanical processing you can create contact between the copper layer and the aluminium layer. When etching, the aluminium must be completely covered against the attack of the etching agent. This is why we put protection foil on both sides of the Cotherm board.

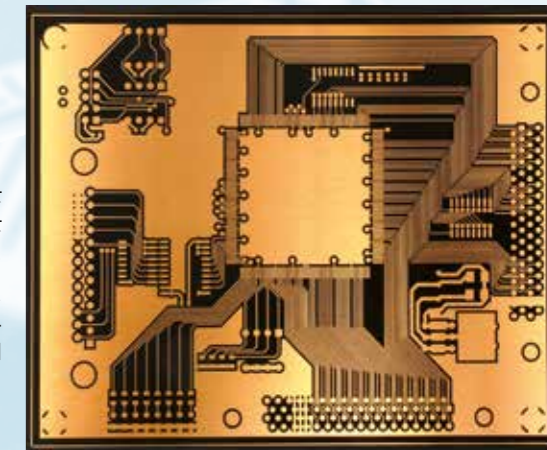
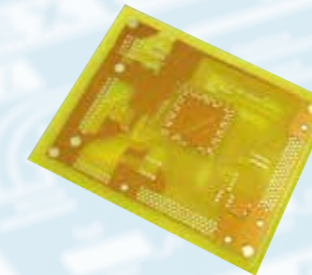

## SURFACE:

If you use ORIGINAL BUNGARD Photopositive Coated PCBs, there is a simple technical alternative to protect the surface of your PCB:

### Step 1:

Etch your ORIGINAL BUNGARD PCB as usual.

### Step 2:

Develop the photoresist after etching once again with a negative film (solder PADS open).

### Step 3:

Apply our immersion tin SUR-TIN just to the now open PADS. The photoresist will stay on the tracks and protect them.

This procedure is not widely known, but gives excellent results. Good solderability on the pads, nice optic and no extra costs!

## ALUCOREX PRESENSITIZED ALUMINIUM

This product is perfectly suitable to manufacture front panels, machine or information plates as well as tampon printing clichés. ALUCOREX consists of an aluminium alloy which is anodized in a unique treatment sequence. After anodizing we coat the boards with a specially adjusted, high-resolution and resistant positive photo-coat. To protect the coat from mechanical damage or unintentional exposure we provide the boards with a light protection foil.

Making a front panel from ALUCOREX is simple and safe. The procedure takes only minutes and you need no equipment besides an exposure unit and a developing tray. The main steps,

- exposure and
  - developing
- take together only 5 minutes.

The colour of the ALUCOREX-boards is already established in the scratch, light and chemical proof anodized layer. The exposed parts of this layer are removed during the developing process.

Image transfer can be done either positive or negative. With a positive image you receive a blanc background and coloured writing or image. With a negative image you will receive a coloured background with blanc writing.

The front panels can easy mechanically processed. With careful handling they can be drilled and punched through the protection foil before exposure. The specially adapted developer is neutralized after the job and can be disposed into the drain. No hazardous waste is created.

One ALUCOREX panel is 480 x 980 mm. We deliver the material in these colours: black matt, black brilliant, red, green and blue brilliant.

- Black matt is available in 0.5, 1.0, 1.5, 2.0, 2.5 and 3.0 mm thickness
- Black brilliant in 1.0, 1.5, 2.0 and 2.5 mm.
- Red and Blue brilliant (both sides are usable) is on stock in 1 mm thickness, as well as the green brilliant clichés, which is only single sided usable.

On request we cut down the

boards according to your wishes till board size 50 x 50mm. Being stored in a cool and dry condition the material has a guaranteed shelf life warranty of up to one year. Tests have shown that even 10 year old material can still be processed.

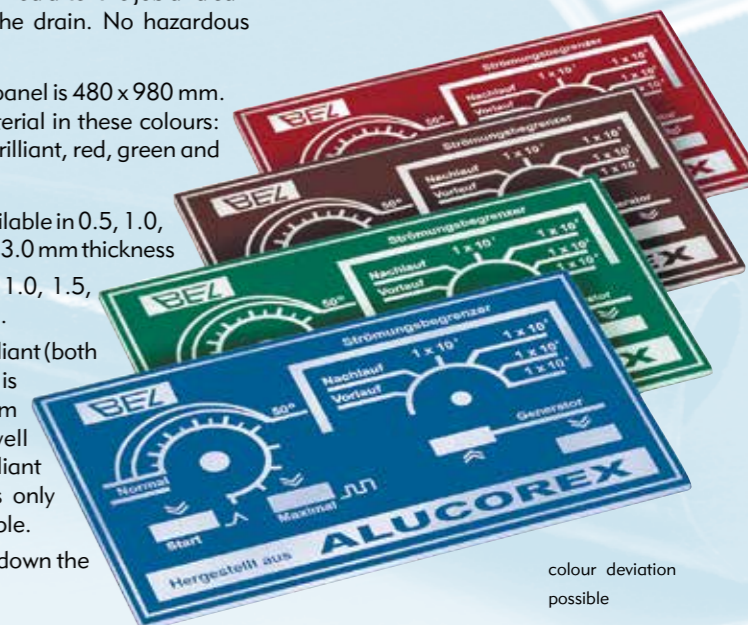

colour deviation possible

## SMD STENCILS

### FOR SOLDER PASTE APPLICATION

From now on, there is a quick, cheap and easy way to make your metal template on your own. With already existing machines and without interference of existing processes.

To do so we offer both positive or negative pre-sensitized metal templates in many dimensions, in different thicknesses and hardnesses.

Being coated with a chemically resistant photoresist of high line resolution and steepness, these templates offer you all the advantages already known from the pre-sensitized laminates for PCBs.

Brass boards are available in 500 x 1000mm. Thicknesses: 0.2, 0.3, 0.4, 0.5, 0.8 and 1.0 mm. Other thicknesses on request possible.

German Silver (CuNiZn) board size 280 x 1000. Thicknesses: 0.1, 0.15, 0.2, 0.3, 0.4 and 0.5. Other thicknesses on request possible.

## NE-CUT

### BOARD CUTTER

The Board Cutter Ne-Cut was specially developed to cut PCBs up to 3.0 mm of thickness or aluminium up to 1.5 mm. If desired cutting of steel sheets up to 1 mm or plastic up to 5 mm is possible as well as cutting of film sheet material or paper. With the transparent hood and the removable downholder you can cut pieces „on sight“.

#### Features

- Cutting width max. 530 mm
- Two blades made of hardened and ground steel
- Spring loaded built-in clamping unit in the front (removable)
- Bedstop with metric scale in the right front
- Fully adjustable back stop with metric scale for batch work (0...300 mm)
- Angle and scale tolerance 0.1 mm
- Durable full steel construction
- All important parts angular adjustable
- Simple exchange of blades
- Adjustable cutting angle
- Adjustable clearance

### NE-CUT

Sizes (LxWxH): 740 x 450 x 290 mm  
Weight: 66 kg



## STENPRINT 3000

### STENCIL PRINTER

The StenPrint3000 is a manual printing system with a stable base for a high print quality. The solid construction provides clean and reproducible pressure with simple handling, even with small components and fine structures down to 0.5 mm.

It is ideally suited for the production of prototypes and small series.

In the basic model, one-sided and double-sided printed circuit boards can be printed with the help of the magnetic circuit board holders.

For this purpose, the circuit boards are fixed on the base plate and supported by the magnetic circuit board holders. By means of rotary knobs, the print alignment can be performed quickly and easily in X-Y and Theta axis.

A parallel lift ensures a clean separation of the printed circuit board and stencil and guarantees a perfect print image.



For double-sided printing you can fix the pcb with the magnetic pcb-holders (this is mandatory when using the universal stencil clamping frame)

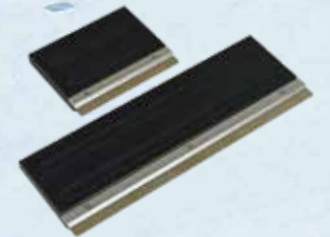

### VARIATIONS

Three types of stencil supports are available.

#### Stencil holder frame

For the simplest of tasks, there is the universal stencil holder frame in which the stencils can be easily clamped without tension.

#### Stencil clamping frame

Optimal is the use of the universal stencil clamping frame. Various stencil sizes can be used here. The tensioning is carried out from two sides. No perforation of the stencil is required.

#### Mounting rail

The third option is a mounting rail for the use of fixed aluminum frames or common quick-release systems.



### STENPRINT 3000

Dimensions (LxWxH)	400 x 640 x 150 mm lid closed
Floor space	545 x 360 mm
Clamping frame size	max. 460 x 30 x 355 mm
Table / usable area	max. 390 x 290 mm
Adjustment range X / Y	+/- 7,5 mm
Theta adjustment range	+/- 3°
Parallel lift	2 mm
Weight	approx. 15 kg plus options
<b>With stencil holder frame:</b>	
Template size	max. 420 x 320 mm
PCB size / usable area	max. 380 x 280 mm
<b>With stencil clamping frame:</b>	
Template size	max. 360 x 280 mm
PCB size / usable area	max. 330 x 270 mm
<b>With magnetic holder set for two-sided printing:</b>	
Circuit board bottom	max. 18 mm

# FILMSTAR-PLUS

## PHOTOPLOTTER

Filmstar-Plus is the name of the next generation of our bitmap photoplotter series. Optimized for inhouse production of high end film layouts at reasonable price level the system can directly proceed (extended) Gerber files (RS 274X or RS 274C) or b/w bitmap (.bmp) files.

Filmstar, your nicely designed partner in cost effective production of your required film artworks.

### Features:

- Film is fixed on a rotating drum. A highly focused red light laser diode is moving stepwise alongside that drum, driven by a precise stepper motor with worm and gear drive. Of course, all settings are software adjustable, calibrated and controlled.
- Film data read in either by USB connection to your computer or by USB stick.
- Full software package belongs to extend of delivery. It offers all required functionality like film arrangement, reverse and mirror image selection, preview, print preview, editing of apertures (e.g. for soldermask films oversizing) and lots more.

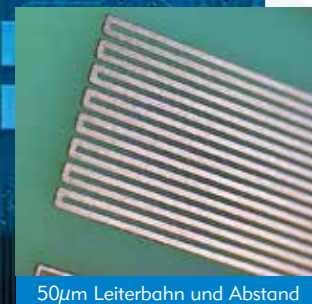

50µm Leiterbahn und Abstand

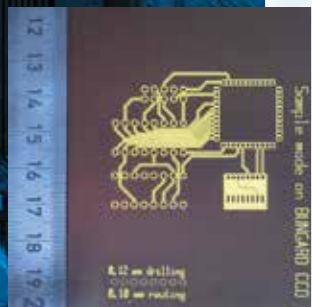

### Features:

- Precise edge definition in photo quality
- Perfect blackness results in perfect opacity
- Extended software package included in delivery

### Improvements compared to Filmstar FP 8000:

- Higher resolution, up to 16 256 x 25 400 dpi
- Stand alone unit - no separate PC necessary. Data can be transferred to the plotter either via USB stick or via USB cable
- New electronics with Touch-Display and intuitive user interface
- Software update: customized Windows optics, Windows routine for opening and saving of files. Higher resolutions in Gerber2bitmap, various calibration programs in Run\_Photo\_USB
- 3 different plot speeds for either high precision or less time consumption

## FILMSTAR-PLUS

	max. film size	max. plot format
Small	250 x 380 mm <sup>2</sup>	230 x 360 mm <sup>2</sup>
Standard	390 x 380 mm <sup>2</sup>	360 x 360 mm <sup>2</sup>
XL	380 x 460 mm <sup>2</sup>	360 x 430 mm <sup>2</sup>

- output resolution from 1625 ... 16256 dpi x 12700 dpi (25400 dpi internally)
  - Plotting speed: 7 mm of film width (x 365mm film length) per minute for 2032 dpi. (20% quicker at 1625dpi, half speed for 4064 dpi)
  - Source of light: Laser diode 670 nm (red)
  - Data input: Gerber (RS 274D, RS 274 X), high resolution BMP
  - Photoplotter software, included on CD:
  - Gerber viewer; automatic aperture converter for all known electronic CAD layout systems
  - D-code editing, output preview & print
  - Interactive, absolute or relative image positioning, film and drill panelization
  - Reversed (negative) plotting, image mirroring
  - Control software requires computer with Windows XP™ to Windows 10™ (64-bit), USB port
- Dimensions (LxWxH):** 700 x 350 x 200 mm  
**Weight:** approx. 20 kg  
**Power supply:** External power supply 110V-240V / 24V-2A

# BUNGARD LASER DIRECT IMAGING (LDI)

Bungard LDI, UV laser direct imaging system for all common types of photoresists.

Target Customers are electronic developers with frequent layout changes, who want to process their PCB prototypes (e.g. antenna structures), in wet processing technology according to industrial standards. Most samples shown here were typically made in about 3 minutes.

The laser head has a resolution better than 50 microns and will be available either as an add on item for existing CCD machines as well as a complete CNC system that can not only expose but also drill and route.

The Bungard Laser Direct will be able to expose a Eurocard pcb in about 15 minutes, depending on the packing density and aspect ratio. To control the laser unit the software LaserPro is required. In LaserPro travel speed, travel height, light energy and start delay (Prelight) can be set for currently 1 - 15 tools.

LaserPro processes HPGL data (HPGL 7475A) in the same manner as the other operating software for the Bungard CCD RoutePro and DispPro. If necessary, the CAD-CAM software IsocomPro is required to convert Gerber Data into HPGL travel paths.

After exposure, the boards can be developed and etched like our normal presensitized base material. The Bungard LDI does not remove copper from the substrate. When lasering copper dangerous gases are produced, that need special collecting neutralizing and disposal measures. In our opinion, etching is the far more user friendly option.



With the Bungard Laser Direct Imaging prototypes can be realized more quickly and accurately than with previous technology. For small series production, we still recommend to make a layout film with the Bungard Filmstar and expose with the Hellas or - for finer resolution - with the EXP 3040 LED

The Bungard Laser head and the software LaserPro are offered at an unbeatable price. They can be retrofitted to all Bungard CCD machines younger than in 2006. Ask us for a quote!

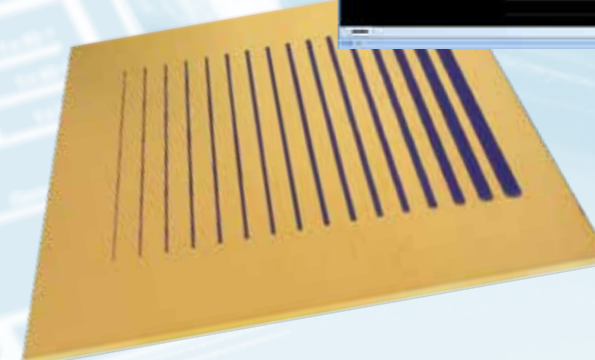
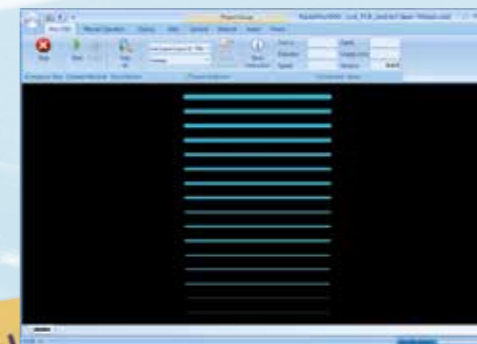
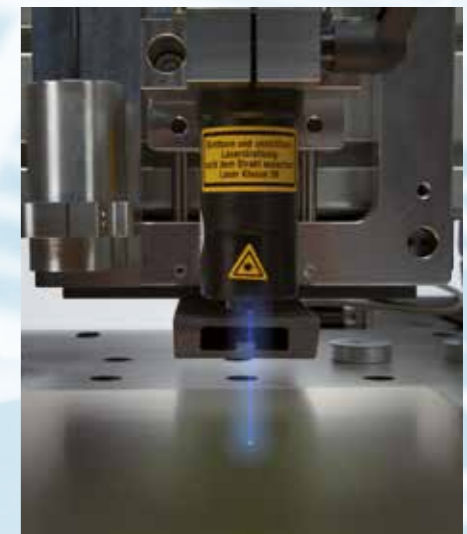

## LASER DIRECT IMAGING

- Laser class:** class 3B  
**Power:** 120 mW  
**Dimensions (LxWxH):** 47 x 47 x 110 mm  
**Safety:**  
 a) Magnetic safety switch; laser turns on only if the unit is mounted facing downward into the CCD holder  
 b) PVC-protection cover with door switch and filter screens recommended  
**Power connection:** Via Bungard CCD  
**Control:** Via Bungard CCD/RoutePro3000  
**Requirements:** Bungard CCD Software RoutePro3000 Laser-License for RoutePro3000  
**Application:** Exposure by UV-laser diode; wave length approx. 406 nm; suitable for positive- and negative photoresist, solder mask and Alucorex

# HELLAS LED

## VACUUM EXPOSURE UNIT

High precision vacuum exposure unit especially designed for double sided contact exposure of presensitized base materials such as tampon printing clichés, PCBs, front-panels, daylight films and other UV sensitive coatings.

### Features

- The Hellas LED 1S is equipped with 42 LEDs and the Hellas LED 2S with 84 LEDs, mounted over a special reflector on each side
- Special reflectors for minimum undercut
- Less energy consumption
- longer worklife of the lights (now +/- 10.000 hours)
- quickstart (less than 1 second)
- maintenance free
- Analogue light emission display
- Lower exposure surface from 8 mm special glass
- Upper exposure area from structured mylar foil in a sturdy frame
- Working area 575 x 365 mm
- Suitable for fine-line PCBs
- Maintenance free vacuum (>60%) with gauge display, 1380 l/hour continuous rating
- Digital timer 1 second - 9 min 59 sec. with count-down, auto-reset and beeper
- Built in cooling fan allows long time exposure or baking processes
- Separate choice of upper/low exposure possible
- Sturdy steel housing



Picture shows LED 2S



HELLAS LED	Hellas LED 2S	Hellas LED 1S	Hellas LED 2S XL	Hellas LED 1S XL
Dimensions (LxWxH):	620 x 650 x 240 mm	620 x 650 x 240 mm	680 x 650 x 240 mm	680 x 650 x 240 mm
Weight:	approx. 40 kg	approx. 40 kg	approx. 45 kg	approx. 45 kg
Electrical Connection:	230 V~, 50-60 Hz, approx. 300 W	230 V~, 50-60 Hz, approx. 200 W	230 V~, 50-60 Hz, approx. 300 W	230 V~, 50-60 Hz, approx. 200 W
Exposure area:	approx. 570x300mm	approx. 570x300mm	approx. 575x365mm	approx. 575x365mm
Number of LED	2 x 84	1 x 42	2 x 84	1 x 42
Separate switch on and shutdown of the exposure flat	Yes	No	Yes	No
Permant Exposure	Yes	Yes	Yes	Yes
Cover Switch	Option	Option	Option	Option
Digital timer	Yes	Yes	Yes	Yes
Cross-flow fan	Yes	No	Yes	No
Milky Foil for Clichee	Option	Option	Option	Option

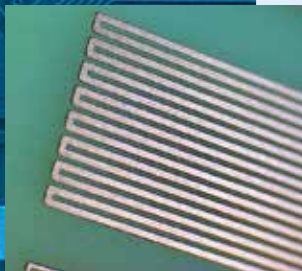
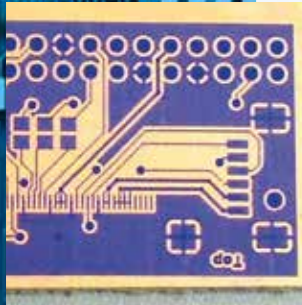

50µm Leiterbahn und Abstand

# EXP 3040 LED

## HIGH SPEED DOUBLE SIDED EXPOSURE

The EXP 3040 LED is a high speed double sided exposure machine mainly designed for high resolution production of printed circuit boards, stencils and clichés in small and medium quantities !

Two special 50 W LED bulbs ensure almost parallel light.

### Construction

Sturdy aluminum frame construction. The chassis consists of a sliding drawer system.

### Operation

EXP 3040 LED guarantees a perfect exposure within a minimum of time and energy consumption. A touch display allows easy preset and read out of all settings. UV-light emission controllers are not necessary with LED technology because the bulbs have a lifetime of plus 10.000 hours with very constant light emission.



A vacuum pump provides a close and uniform contact between artwork and board. The machines have powerful cooling fans for the LEDs.

### Features EXP 3040 LED:

- Max. Working area 300 mm x 580 mm (recommended: 300 mm x 400 mm)
- Vacuum assisted drawer
- Suitable for fine line PCBs
- Suitable for exposure and curing of solder mask.

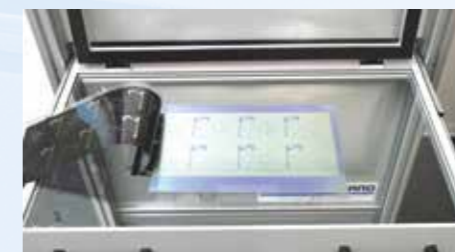

## EXP 3040 LED

**Power supply:** 90-230 V, 50-60 Hz, 1-phase, 4 A, 800 W  
**Fuse:** 5 A  
**Unit Size (WxDxH):** 780 x 820 x 1620 mm  
**Weight:** 120 kg



## JET 34D

### SPRAY ETCHING MACHINE

Powerful spray etching or spray developing machine mainly designed for use in pcb labs. Capacity up to 3m<sup>2</sup>/h possible (single-sided, positive material).

#### Features

- Maintenance free system with self-cleaning nozzles
- Etching speed of 35µm Cu within 90 seconds (warm Fe-III-Cl)
- Line resolution better than 0.1 mm
- Big lid for easy loading, with built-in security switch
- Recommended board size: 300 x 400 mm (Maximum 350 x 450 mm)
- Small PCBs can be fixed on carrier with adjustable holder
- Easy and clean handling by hinge free lid and handle outside of machine
- If you turn the carrier you can etch double sided
- Overflow wash tank in the front for rinsing etched boards
- Digital timer with countdown, auto-reset and beeper
- Sturdy construction fully made of PVC and titanium
- Suitable for all common etchants. Also well suited for spray developing of dryfilm resist (anti-foam agent recommended)
- Strong 1000 W heater with thermostat and over-heat fuse
- 3 cog valves (etching tank, rinse overflow, rinse inlet)



### JET 34D

Dimensions (LxWxH): approx. 600 x 700 x 1100 mm  
 Working Level: 900 mm  
 Power supply: 220 V~, 50Hz, approx. 1.5 kW  
 Tank capacity: 16 l  
 Weight: 35 kg



## SPLASH

### SPRAY ETCHING MACHINE

Spray etching machine for laboratory use with integrated static rinse. Machine is suitable for double sided material. Special emphasis was put on ergonomical and clean etching and rinsing as well as on low chemical drag out.

#### Features

- Maintenance free system with self-cleaning nozzles and magnetic pump
- Etching speed of 35 µm Cu within 90 seconds (warm Fe-III-Cl).
- Big window to the etching chamber made from transparent PVC.
- Maximum board size: 210 x 300 mm. Splash XL: 300 x 400 mm
- Line resolution better than 0.1 mm (100 µm)
- Suitable for all common etchants
- Lid to the etching chamber with safety switch
- Removable board holder made from Titanium and PVC. Can be locked in drip-off position
- Easy access to the etching chamber.
- Strong 1000 W Quarz heater, controlled by thermostat
- Overheat fuse
- Digital timer with count down, auto reset and beeper.
- Integrated rinsing zone with drip off holder.
- 3 cog valves for all tanks
- Suitable for spray developing



### SPLASH

Power supply: 230 V~, 50 Hz, approx. 1,5 kW  
 Dimensions (LxWxH): 600 x 660 x 1200 mm  
 Working Level: 900 mm  
 Etchingformat: 210 x 300 mm  
 Weight: 35 kg  
 Tank capacity: approx. 23 l

### SPLASH XL

Power supply: 230 V~, 50 Hz, approx. 1,5 kW  
 Dimensions (LxWxH): 800 x 650 x 1200 mm  
 Working Level: 900 mm  
 Etchingformat: 310 x 400 mm  
 Weight: 40 kg  
 Tank capacity: approx. 35 l



## SPLASH CENTER

### SPRAY ETCHING MACHINE

Laboratory etching machine with static and spray rinse, integrated developer tank, a reserve tank for e.g. chemical tinning and a squeeze dryer. The Splash-Center is suitable for double-sided PCBs. Special emphasis was put on ergonomical and clean etching and rinsing as well as on low chemical drag out.

#### Etching compartment:

- Maintenance free etching system with solid stream nozzles
- Etching speed of 35  $\mu\text{m}$  Cu within 90 seconds (warm Fe-III-Cl).
- Big window to the etching chamber made from transparent PVC.
- Maximum board size: 210 x 300 mm / Splash-Center XL: 300 x 400
- Line resolution better than 0.1 mm (100  $\mu\text{m}$ )
- Suitable for all common etchants. Fe-III-Cl recommended
- Lid to the etching chamber with safety switch

- Removable board holder made from Titanium and PVC. Can be locked in drip-off position
- Easy access to the etching chamber.
- Strong 1000 W Quartz heater, etching temperature controlled by thermostat
- Overheat fuse
- Digital timer with count down, auto reset and beeper.
- Integrated rinsing zone with drip off holder.
- 3 cog valves for all tanks
- Suitable for spray developing

#### Developer and rinse compartment:

- Magnetic centrifugal pump to revolve developer
- two integrated static rinses, one can be used for neutralization purposes
- Fresh water spray zone activated by foot switch, including splash protection
- A reserve tank, e.g. for immersion tin
- 5 ball valves to drain all tanks, cover protected from the front side.
- All tanks with lids
- Integrated drip tray for all tanks, sure-footed about 120 mm above the ground
- Integrated mechanical squeeze dryer



### SPLASH CENTER

Power supply: 230 V~, 50 Hz, 1,5 kW  
 Dimensions (LxWxH): 1000 x 670 x 1200 mm  
 Working Level: 900 mm  
 Etchingformat: 210 x 300 mm  
 Tank capacity: 1 x 23 l + 1 x 12 l + 3 x 8 l  
 Weight: 46 kg

### SPLASH CENTER XL

Power supply: 230 V~, 50 Hz, 1,5 kW  
 Dimensions (LxWxH): 1140 x 770 x 1200 mm  
 Working Level: 900 mm  
 Etchingformat: 310 x 400 mm  
 Tank capacity: 1 x 35 l + 1 x 22 l + 3 x 15 l  
 Weight: 56 kg



## DL 500

### CONVEYORISED SPRAY ETCHING MACHINE

The DL 500 is a double sided conveyorised spray etching machine with integrated rinsing zone. This machine is easy to maintain and fits perfectly to a modern PCB laboratory. The maximum capacity within one hour is 10 m<sup>2</sup>. Designed for being used for laboratory purposes, there are lots of different applications (e.g. spray developing of tenting or solder mask) and options available. Of course the machine can be modified according to your needs.



#### Features:

- Working width 510 mm
- Adjustable conveyor speed 0 - 1.5 m/min.
- Joint free belt drive
- PCB is firmly secured by upper and lower transport rollers
- Powerful etchant pump (200 l/min)
- Double sided etching with 4 x 14 flat jet nozzles. Due to special nozzle pattern, there are 6 rows of nozzles for each side!
- Adjustable spray pressure. Upper and lower spray pressure can be regulated separately
- Thermostat with digital read out and self-safe overheat cut-off
- Integrated rinse zone. Optional fresh water rinse with solenoid valve or recycle watertank
- Drying by squeezing rollers with tissue

- Sturdy stand alone construction from PVC and Titanium
- Transparent top with security switch
- Line definition down to 35  $\mu\text{m}$  lines and spaces on 18  $\mu\text{m}$  copper
- 1000W quartz heater
- Maintenance free design, just normal cleaning/refilling
- Easy disassembly and full access to all inner parts without special tools
- Suitable for all regular etching agents. We recommend to use ferric-chloride. Please pay attention to the special features of each etchant (crystallization of persulfates and ammonium, exothermic reactions while etching). For alkaline etching, machine must be modified.

### DL 500

Power supply: 230 V or 400 V, 50 Hz, 1.5 kW  
 Dimensions (LxWxH): 1200 x 670 x 1290 mm  
 Etchingformat: 510 mm  
 Tank capacity: 55 l  
 Weight: 100 kg



## Variants of the DL 500

### Variant 1: Spray Developing Machine

The DL 500 can be used as a spray developing machine for negative and positive etch resist or solder mask without modifications. Simply change the media!

### Variant 2: Spray Etching Machine

Standard variant

### Variant 3: Spray Stripping Machine

This machine is equipped with an additional filter basket at the front side of the machine to remove residues of tenting or solder mask from the stripping liquid (see picture on the left).

## Options for the DL 500

### Option 1: Recycling Rinsing Tank

Recycling rinsing tank with magnetic centrifugal pump instead of fresh water. Saves water costs. With a cock drain valve the used rinsing water can be used to compensate evaporation losses or to make up new etching liquid. Waste water free rinsing technique. The magnetic valve from the standard version is here obsolete. The tank fits underneath the machine body of DL 500.

Dimensions (LxWxH): 200 x 700 x 600 mm

### Option 2: Conveyorised Rinsing Unit

a.) Conveyorised rinsing unit, stand alone version with adjustable conveyor speed, integrated magnetic valve for fresh water inlet (controlled by DL 500), squeeze drying roller. Transport width and height same as DL 500.

Dimensions (LxWxH): 450 x 620 x 940 mm

b.) As above but second stage cascade rinse (in combination with recycling rinsing tank and magnetic centrifugal pump), 3 way cock valve to bypass rinsing water e.g. to water treatment unit IONEX.

Dimensions (LxWxH): 450 x 620 x 940 mm

### Option 3: Inspection Table

Control zone in form of a roller table (not conveyorised). This roller table can be mounted between two DL 500 (e.g. Developer and Etcher), between DL 500 and rinsing unit or as a single exit table.

Dimensions (LxWxH): approx. 620x50x530 mm

### Option 4: Production Line

3 DL 500 and the rinsing unit can be connected to a small production line (Developing – Etching – Stripping - Cleaning) coupled together with inspection tables. Of course other variants are possible as well.

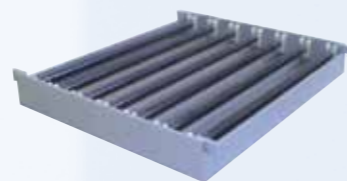

### Option 5: DL 500 S

This machine is equipped with an additional filter basket at the front side of the machine to remove residues of tenting or solder mask from the stripping liquid.



### Option 6: DL 500 Vario

DL 500 Vario with separate adjustable spray pressure for the upper and lower side.

For physical reasons the etching result from the upper side is different from the lower side. Adjusting the spray pressure for one side may compensate this phenomena. In contrast to etching machines from competitors the PCB in the DL 500 is firmly fixed throughout the whole process by upper and lower transport rollers. This makes it possible to switch off completely the upper nozzles without lifting the PCB by the spray pressure of the lower nozzles.

### Option 8: DL 500 triple phases power supply

You can order the DL 500 either with a single phases or triple phases power supply.

Triple phase power supply is recommended for permanent use.

### Option 7: Cooler

Some etching agents as well as other chemicals tend to exothermic reactions and need to be cooled during the treatment process. For this purpose we offer a special cooler for the DL 500. The Cooler consists of a recycling rinsing tank with cooling coils for the etching liquid. With a cock valve the etching agent is adjustable bypassed through the cooler.



### Option 10: Exit table



### Option 9: Filter unit

On request you can equip your DL 500 with one or two 10" filter units to remove residues from the etching process. You can easily adjust the filter throughput via cock valve. On the picture you can see a filter unit together with an exit table.



# TITAN 3500

## ROTATION WHEEL ETCHER FOR DOUBLE SIDED SHEETS

The Titan 3500 is a double-sided spray etcher for high precision applications.

In addition to the patented nozzle system, which ensures uniform wetting of the substrate, the substrate is rotated during the etching process to reliably prevent the formation of an etch shadow and uneven etching by e.g. the trace geometry. This enables structure resolutions down to 40µm with a copper thickness of 35µm.

As material PVC and PP are used, all metal parts that come into contact with the etching medium are made of titanium, e.g. the titanium heating. The side walls and tank bottom are made of 8 mm thick PVC.



This results in an extremely robust compact construction. The high-precision etching result is achieved by the uniform volume flow of the nozzle spray bar in conjunction with the rotating clamping wheel and the uniform liquid flow of the etching medium.

The special nozzles are internally designed in such a way that the full spray cone strikes the rotating etch material with a twist.

During the etching process, the clamping wheel is constantly rotated via a geared motor and transport rollers.

The titanium heating is controlled by a digital thermostat. The etchant pump is controlled by a digital timer with automatic reset and final acoustic signal. Setting range 0-599 seconds.

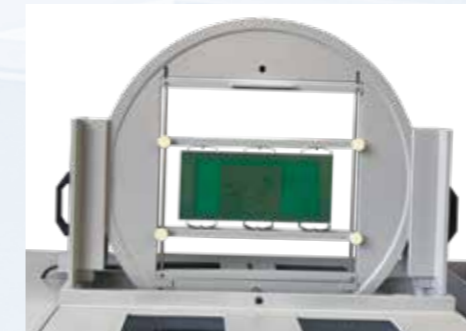

### TITAN 3500

Power supply:	230 V~, 50 Hz, ca. 1,8 kW
Dimension (LxDxH):	950 x 750 x 1100 mm
Working height:	1150 mm
Usable format:	max. 350 x 350 mm
Tank volume:	28 l
Etching pump:	Magnetic centrifugal pump with approx. 80l/min throughput (gross)
Weight:	90 kg
Digital-timer for time range:	0-599 sec.
Temperature range:	0 – 55 °C
Height cog valve (emptying):	ca. 300 mm



# SPRINT 3000

## CUSTOMIZED ETCHING SYSTEM FOR YOUR PCB LABORATORY.

The Sprint (3000/4500/6000) series is made for double sided PCBs with line resolution down to better than 0,1 mm. Machine is available as table top or floor standing version. With this range of products, complete production lines are possible covering developing, etching and rinsing including waste water treatment.

Outstanding feature is the transport unit, which is fully removable for cleaning purposes and may be extended or shortened almost arbitrarily, and thus allows custom changes or machine designs. Standard machine has a width of 300 mm (SPRINT 3000) but wider machines are available (450 mm= Sprint 4500 / 600 mm = Sprint 6000).

### Technical highlights:

- Small footprint, easy handling, control panel at the front
- Service friendliness: All nozzles with self-adjusting Bayonet Lock: no readjustment!
- Transport: the complete transportation unit can be easily taken out of the machine for cleaning and is based on a maintenance-free bevel gear system (titanium-PP) with horizontal gear shaft
- Transport speed infinitely variable from 0-2m/min
- Short etching time and high etching precision due to high end spray nozzles arranged in nozzle bar
- Machine equipped with filter for etchant
- Titanium heater, controlled by digital thermostate with function control
- Integral closed loop rinse plus fresh water rinse, upon request also with motion detector
- Clean and easy emptying of all tanks via cock valves
- Security features: cover switch and emergency stop

### Possible options:

- Working width: 450 mm / 600 mm for Sprint 4500/6000
- Sensor control for fresh water rinse (motion control)
- Additional suction hood, swiveling
- Upper / lower pressure adjustable via cog valve
- Additional rinsing sections possible
- Etching zone can be enlarged to 2x / 3x / 4x length
- High pressure pump for rinsing
- Titanium cooling coil, electrically controlled to reduce bath temperature in case of danger of exothermal reaction
- Run dry protection (double security for heater elements)
- Underframe with or without security tray
- Transmitting height up to 10mm (e.g. for pad printing clichés)
- Can be supplied with waste water treatment unit
- Oscillation module possible

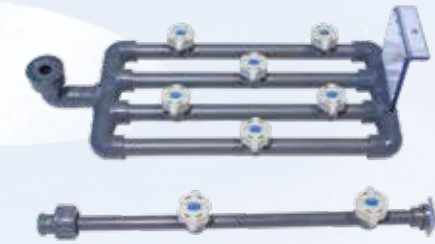

Combination of Sprint 3000 + Middle section + Sprint 300



Combination of Sprint 3000 and AquaPur 1000

# AQUAPUR 1000

## WASTE WATER TREATMENT SYSTEM

AquaPur (1000/3000/5000) cleans rinsing water from solids and heavy metals such as copper or iron of small to medium series of PCB production.

The ion exchangers of this system are suitable for alkaline and acidic rinse water from the etching process.

The use of a special mixed bed resin for anions and cations, which can be regenerated, avoids the use of other chemicals e.g. for pH adjustment and ensures easy operation.

The system operates in closed loop circulation and is directly connected to the respective rinsing zones of the etching machine.

The spray pressure and the flow rate can be read and adjusted at the diaphragm valve and the Flow meters.

The contaminated rinse water of the machine flows into a storage tank integrated into the AquaPur.

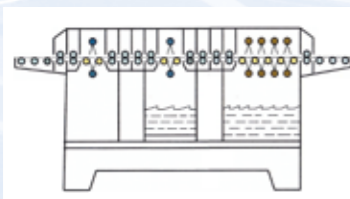

Option: Additional suction hood

Option: Underframe

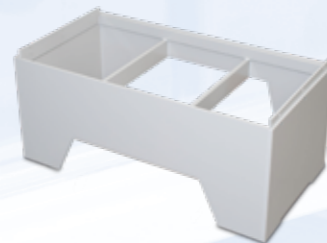

## SPRINT 3000

Power supply:	230 V~, 50 Hz, 1,5 kW
Overall size: (L x W x H):	1100 x 750 x 750 mm
Working width:	300 mm
Tank capacity:	210 x 300 mm
Tank capacity:	20 l (etchant), 15 l (close loop rinse)
Weight:	+ 95 kg
Water output:	approx. 80 litre/min
Spray pressure:	+ 1 bar
Working temperature:	0 - 45 °C

## AQUAPUR 1000

Power supply:	230 V~, 50 Hz, approx. 1,5 kW
Dimensions (L x W x H):	900 x 800 x 1500 mm
Working Level:	90 mm
Tank capacity:	approx. 250 l
Ion exchange columns:	2 x 14 l mixed bed resin
Pump pressure:	approx. 1,8 bar
Capacity:	2500 l/h (recommended: 20 l/h)
Weight:	90 kg

# IONEX A, B, KA, KB

## WASTE WATER TREATMENT SYSTEM

The name IONEX stands for ION-EXchanger, which is the very heart of this modern waste water treatment system. The Ionex is a modern and compact plant to treat rinsing water of a PCB laboratory. We offer 4 basic variants, which differ in rinsing water throughput and ion capacity. Type A and B are equipped with a cotton pre-filter, two cation columns and a ph neutralization column. Type KA and KB have three ion exchange columns.

The cation columns color red, when loaded with ferric ions and blue/green, when loaded with copper ions. Loading of anion column can be tested by measuring the conductance of the cleaned water. Loaded columns can be sent to Bungard for regeneration or we support you to do the regeneration yourself.

The drain water quality from this system is in accordance to German directives, which are of the highest standards world wide!

### Features:

- For post-treatment of etching and galvanic rinsing water
- Removal of solids and all heavy metals
- closed water cycle possible (K-versions)
- Decrease of chemical oxygen demand
- Integrated storage sump with capacity of 110 l (A/KA) or 220 l (B/KB) for collecting rinsing water
- Strong built-in hose pump
- Integrated cotton filter candle 10 µm (active carbon filter with K-versions)
- Significant change of color when loaded with metals
- Lower and upper sump level control switch
- Easy handling and operation
- Regeneration of ion exchange resins by supplier or by user at little cost
- IONEX A and B perform additionally PH neutralization and discharge to the drain



### IONEX A / KA

Power supply:	230 V, 50 Hz, 50 W
Weight:	30 kg
Tank capacity:	110 l
Cleaning capacity:	10 l/h
Dimensions (LxWxH):	700 x 430 x 1300 mm

### IONEX B / KB

Power supply:	230 V, 50 Hz, 100 W
Weight:	60 kg
Tank capacity:	220 l
Cleaning capacity:	20 l/h
Dimensions (LxWxH):	900 x 600 x 1500 mm



As an option the IONEX can be equipped with a conductivity meter (IONEX KA/KB) or a ph-meter (IONEX A/B). This way you have the quality of the treated rinse water always under control.



### Closed loop rinsing water:

IONEX KA and KB filter next to the metallic cations also the anionic halogens from the rinsing water, so you receive demineralized water. The demineralized water is collected and pumped back to the etching or through-hole-plating machine.

IONEX scheme A-B

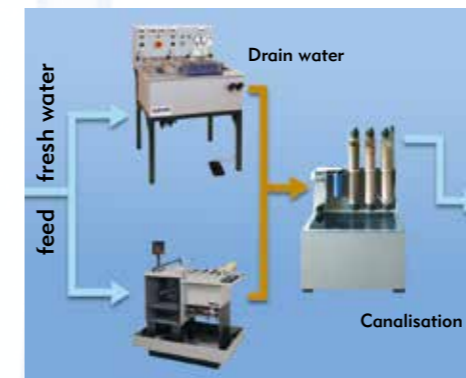

IONEX scheme KA-KB



Of course the machines of the IONEX family can be adapted according to your needs. The IONEX XXL e.g. cleans 1500 l of rinsing water. The IONEX AU filters gold ions out of rinsing water from a nickel-gold-processing machine. These gold ions can be regenerated and returned to the gold bath.



## ACCESSORIES FOR YOUR PCB - LAB

### Processing Dishes for PCB lab.

Rigid trays suitable for deloping, etching, stripping, immersion tinning.

The trays, which have a spout to facilitate emptying, are available in three sizes.

Insize:

- 350 x 450 x 75 mm
- 250 x 320 x 60 mm
- 210 x 260 x 50 mm



### Stripper for positive and negative photoresists



### Green Coat solder paint



### Developer for positive presensitized boards



### Chemicals for galvanic through hole plating



### Developer for negative presensitized boards



### Sodium persulfate



### Immersion tin SUR-TIN



### Stain remover RX 3



## FAVORIT

### THROUGH-HOLE-PLATING

Hand-operated machine, especially for mechanical through-hole-plating purposes. Professional through-hole-platings by individual tools for each rivet diameter. Optimal contacts, even without soldering. Favorit offers high quality results at a low cost level.

#### Special features:

- Adjustable depth limiter
- Maximum board size: 400 mm

#### Extend of delivery:

- The offered system includes complete press + tools
- Inclusive 1 x 1000 rivets
- Inclusive 1 set of tools
- Various tools and rivets are available
- Please specify the inner diameter you require
- Different tools have to be used for different diameters



### FAVORIT

Dimensions (LxWxH): approx. 95 x 300 x 210 mm  
 Working depth: 200 mm  
 Weight: approx. 4 kg

Rivet with inner diameter/mm: 0.4 0.6 0.8 1.0 1.2 1.5  
 Required drill diameter/mm: 0.6 0.8 1.0 1.5 1.7 2.0

# VARIODRILL

## PCB DRILLING SYSTEM

VARIODRILL is a PCB drilling machine for prototypes and small batch production.

The demand for operating comfort and high quality has led to an untraditional design which meets the necessary requirements for an ergonomic correct working position.

### Features:

- comfortable working position, drill table can be tilted up to 30°
- magnifier optics directly over the drill hole (parallax free)

- Illuminated work area
- Motor controlled, adjustable stroke speed, spindle underneath the table
- Infinitely adjustable 10.000 ... 30.000 RPM
- AC Motor, 100 Watts / 230 Volt
- Including foot switch for easy operating
- Booth hands are free for positioning the PCB
- Complete system with integral dust extraction
- Including external vacuum cleaner
- Throat depth: 115 mm, max. board size 230 mm x endless
- Chuck: 1/8" (3.2mm)
- Drill size 0.6 to 3.2 mm

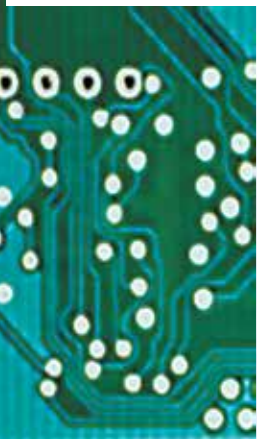
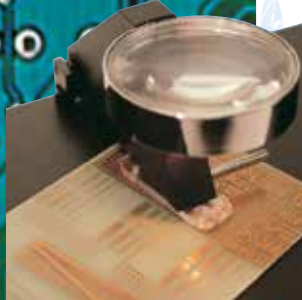

### VARIODRILL

Chuck:	3.175 mm
Dimensions (LxWxH):	340 x 240 x 175 mm
Weight:	approx. 7 kg
Power supply:	220 V~, 50Hz, approx. 0,6 kW + vacuum cleaner

# DRILLS AND ROUTERS

## SOLID CARBIDE

High quality, precision ground solid carbide drill and routing bits with 3.175 mm (1/8") shaft.

All tools have 7.5 mm wide collets with a distance of 21 mm from the tip to the upper side of the collet.

The tool rings show the diameter or are colour coded. Tools come in re-usable plastic boxes.

Within one class of price, tools with different diameters can be mixed to give one unit of 10pc.

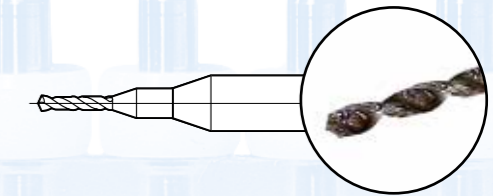

### Tungsten Carbide Drills for drilling PCBs

Two flutes, righthand turn. Diameter: 0.3 ... 3.0 mm in 0.1 mm increments



### Contour Routers - RPU Type

For Aluminium routing/milling. Two flutes, upward swarf ejection, fish tail tipped. On-stock diameters: 0.6, 0.8, 1.0, 1.2, 1.5, 2.0, 2.5, 3.0 mm

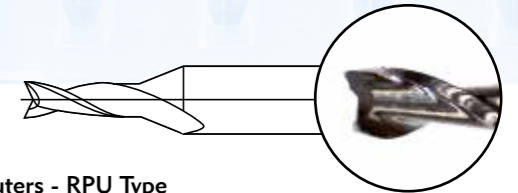

### Contour Routers - SC/FT Type

For PCB routing, diamant shaped teeth, upward swarf ejection, fish tail tipped. On-stock diameters: 0.6, 0.8, 1.0, 1.3, 1.5, 2.0, 2.5, 3.0 mm

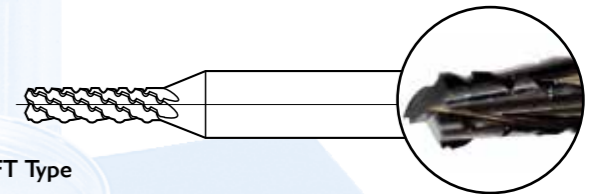

### Special tools for isolation milling < 0,6mm

SC/FT Router cylindrical:

0.3, 0.4 und 0.5 mm

Bungard Special isolation milling routers

0.1 and 0.2 mm

These routers are cylindrical only in the last millimetre. This way there is a low risk of breaking the router.

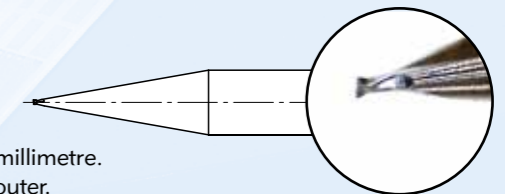

or:

V-Cut Routers G30°N Type

For isolation routing and fine engraving, two flutes, 30° tip angle. For Channels of 0.1 – 0.3 mm width (depending on cutting depth).

Contour Routers G60°N Type

For isolation routing with or for engraving, two flutes, 60° tip angle. For Channels of 0.2 – 0.5 mm width (depending on cutting depth).

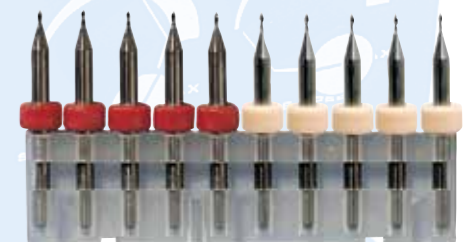





## CHEMICAL ETCHING OR ISOLATION MILLING

Chemical etching or isolation milling that is an often asked question. Find detailed report here: [www.isolationmilling.com](http://www.isolationmilling.com)

In general: Chemical etching needs a film artwork or a laser direct imaging, but, the etching itself is extremely cheap and thus standard in world wide printed circuit board production.

Isolation milling does not need film artwork, but, generates high tooling costs and some application problems. That is why isolation milling is more for first and single prototypes.

## Copper coated aluminium PCBs as normally used in LED applications (Cothem)

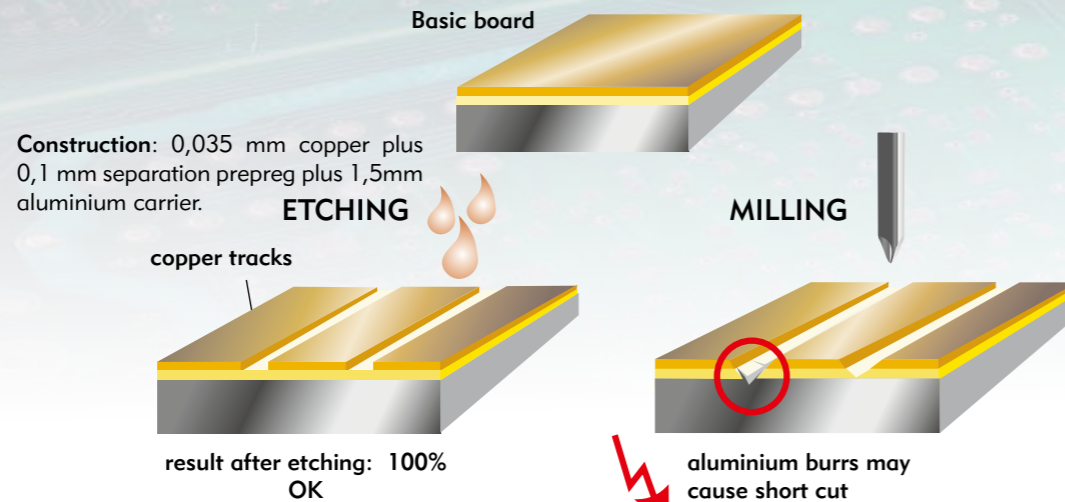

No problem in etching technology. Just need to cover back side and edges of the board to avoid etching of the carrier.

**Problem:** milling technology may destroy isolation layer and burrs may lead to short cuts.

## Thin FR4 boards

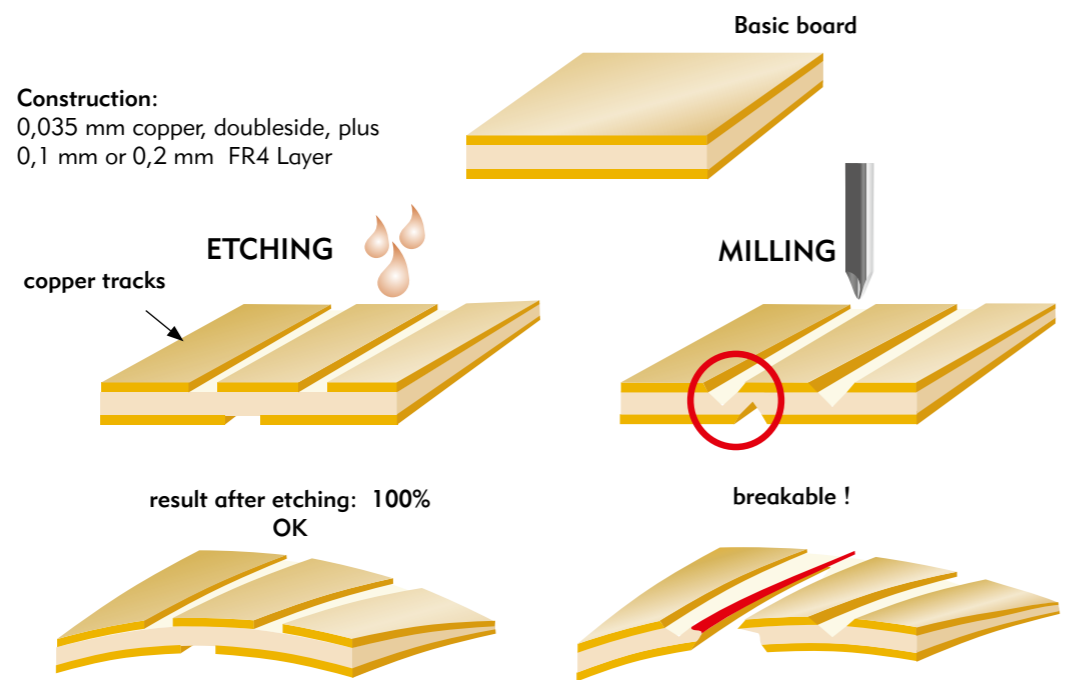

No problem in etching application because FR4 carrier is not effected by etchant.

**Problem:** V-Scoring effect if two isolation milling channels end up on top of each other.

## Multilayer boards with standard preregs for etching

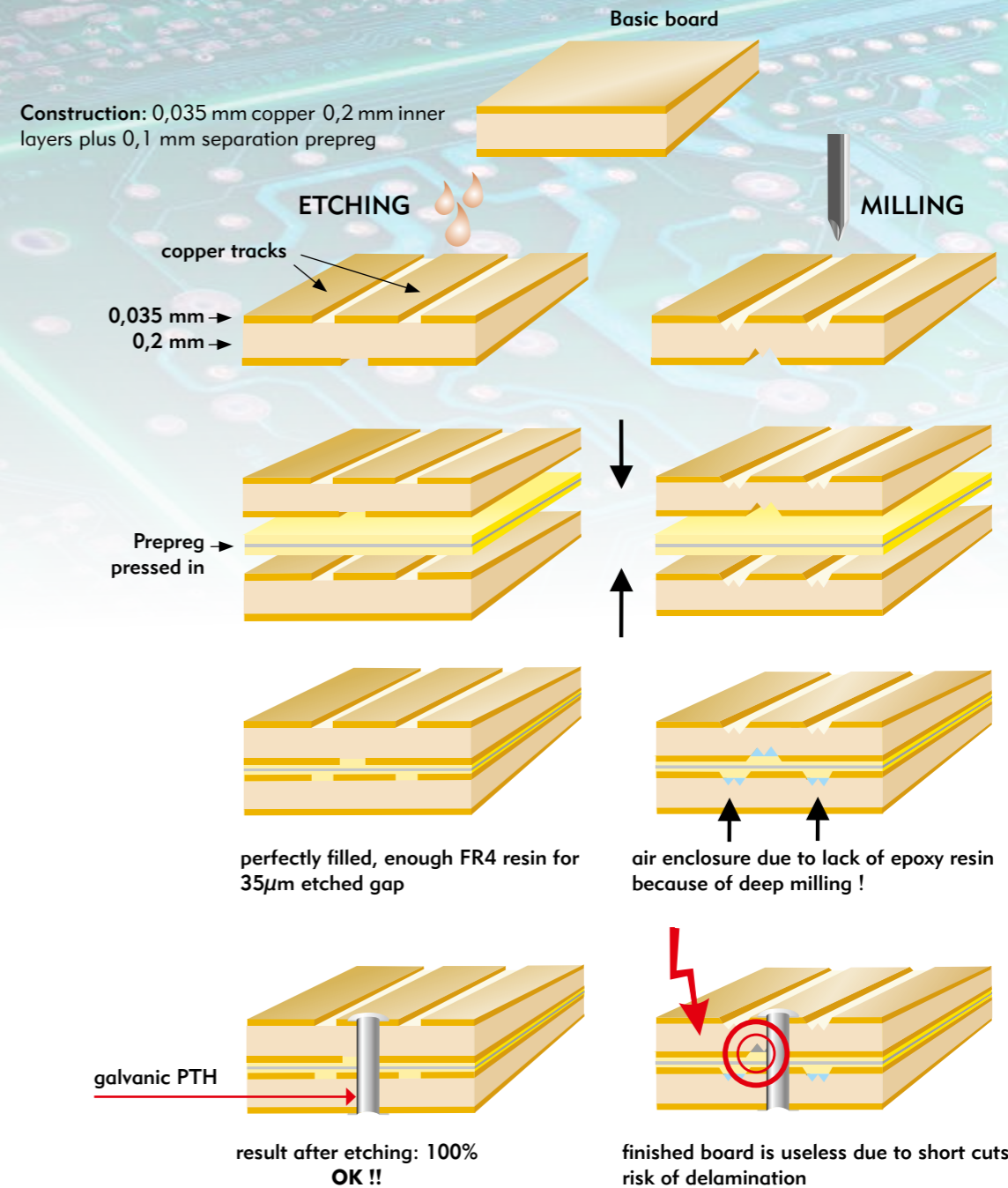

State of art for multilayers should be the etching technology. To avoid layout film production, etching can be combined with Laser Direct Imaging (LDI), to compare advantages of both technologies !

Problem with isolation milling is, that -worldwide - preregs are made for etching application and in order to fill the gap of normal copper thickness of 35µm. Since isolation milling channels are deeper, there is a high risk in production. Air inclusions not filled by resin of the prepreg may end up in short cuts (if touched by a plating through hole) or lead to delamination during e.g. reflow soldering process, due to the expansion of the air bubble.

# BUNGARD CCD SERIES CNC MACHINES



	CCD/2-ECO	CCD/2/MTC	CCD/2/ATC	CCD/2/ATC PRECISION	CCD/MTC	CCD/ATC	CCD/MTC/XL	CCD/ATC/XL	CCD PREMIUM
Weight kg	30 kg	30 kg	30 kg	30 kg	35 kg	35 kg	49 kg	49 kg	80 kg
Dimensions mm	700x550x300	700x550x300	700x550x300	700x550x300	700x800x300	700x800x300	950x950x300	950x950x300	700x850x600
Work area mm	270x325x38	270x325x38	270x325x38	270x325x38	325x495x38	325x495x38	500x600x38	500x600x38	400x500x60
Tool change semiautomatic/manual/ 99 tools	yes	yes	yes	yes	yes	yes	yes	yes	yes
fully automatic with length control	not upgradeable not upgradeable	not upgradeable not upgradeable	yes, 16 tools yes	yes, 16 tools yes	upgradeable upgradeable	yes, 16 tools yes	upgradeable upgradeable	yes, 25 tools yes	yes, 30 tools yes
Milling and drilling single- and double-sided PCBs	☆☆☆	☆☆☆	☆☆☆	☆☆☆	☆☆☆	☆☆☆	☆☆☆	☆☆☆	☆☆☆
Milling/drilling RF- & microwave substrates	☆☆	☆☆	☆☆	☆☆	☆☆	☆☆	☆☆	☆☆	☆☆☆☆
Milling/drilling multilayers with up to 16 layers *	☆☆☆	☆☆☆	☆☆☆	☆☆☆	☆☆☆	☆☆☆	☆☆☆	☆☆☆	☆☆☆
Contour routing of PCBs	☆☆☆	☆☆☆	☆☆☆	☆☆☆	☆☆☆	☆☆☆	☆☆☆	☆☆☆	☆☆☆
Milling flexible, rigid-flex PCBs **	☆☆☆	☆☆☆	☆☆☆	☆☆☆	☆☆☆	☆☆☆	☆☆☆	☆☆☆	☆☆☆
Engraving front panels/labels	☆	☆	☆☆	☆☆	☆☆☆	☆☆	☆☆☆	☆☆	☆☆☆☆
Wave solder pallets and Housing production	☆	☆	☆☆	☆☆	☆☆☆	☆☆	☆☆☆	☆☆	☆☆☆☆
Milling SMT soldering paste stencils and solder frames	☆	☆	☆☆	☆☆	☆☆☆	☆☆	☆☆☆	☆☆	☆☆☆☆
UV-laser-exposure	☆☆	☆☆	☆☆	☆☆	☆☆	☆☆	☆☆	☆☆	☆☆☆☆
Panel cutting, Reworking PCBs	☆☆☆	☆☆☆	☆☆☆	☆☆☆	☆☆☆	☆☆☆	☆☆☆	☆☆☆	☆☆☆☆
Test adapter drilling	☆	☆	☆	☆	☆☆☆	☆☆☆	☆☆☆	☆☆☆	☆☆☆☆
Cooling	☆	☆	☆☆	☆☆	☆☆☆	☆☆	☆☆☆	☆☆	☆☆☆☆

\*) we generally recommend to etch at least the inner layers of a multilayer pcb  
\*\*) for flexible materials vacuum fixation is a nice option

☆☆ well-suited    ☆☆☆ very suitable    ☆☆☆ ideal

# BUNGARD CCD/2-ECO

## CNC MACHINE

The Bungard CCD/2-Eco completes the Bungard CNC segment for the low price level. The machine is especially interesting for beginners with a low budget, because it has on the one hand an unbeatable price, but on the other hand offers the same mechanic quality and precision of all other Bungard CNC machines.

Unlike all other CCDs, this machine is equipped with a low-cost eco-spindle which allows speeds from 5000 up to 35000 U / min. For normal everyday work such as isolation milling and contour milling of printed circuit boards, this spindle is highly sufficient. For aluminum and non-ferrous metals however not. Of course the machine can be upgraded at any time thereafter with a high-speed spindle.

The CCD/2-Eco is a high quality Computer Controlled Drilling machine with semi-automatic tool change. It allows direct processing of Excellon / Sieb & Meyer drill data or HP-/GL data for the production of printed circuit boards (drilling, milling, isolation routing) and milling/engraving of plastics.

In addition to the spindle the Bungard CCD/2-Eco can be upgraded with a dispensing device for solder paste or glue, a laser exposure head for exposing photoresists and a camera for calibration and inspection tasks.

## SCOPE OF DELIVERY:

- Mechanic unit + control unit + complete cabling
- Superb and sturdy high frequency spindle with eddy current brake and load control
- Integrated mechanical milling depth limiter and pressure foot
- Driver software RoutePro3000 (Windows 7™- Windows 10™ - 64bit) for drilling and milling
- Powerful, adjustable (500-2000 W) + start adapter for vacuum cleaner (vacuum cleaner not included)
- Manual, USB/serial adapter, Set of Allen Keys

**best choice for prototyping of printed circuit boards and isolation milling**



Videoclip of Bungard CCD



Picture shows power supply of CCD/2/ECO

## OPTIONS:

Vacuum table, protection hood or protection rack, converter software IsoCam, fiducial recognition and calibration with camera, laser exposure of photo resists, aluminium work table, routers engine adapter for plastic milling and many more.

Upgrade to Kavo high-frequency spindle (this requires: Spindle holder 33mm, spindle 4010, inverter in Al-housing for mounting on the Y-carriage, 8-wire Chainflex control wire).

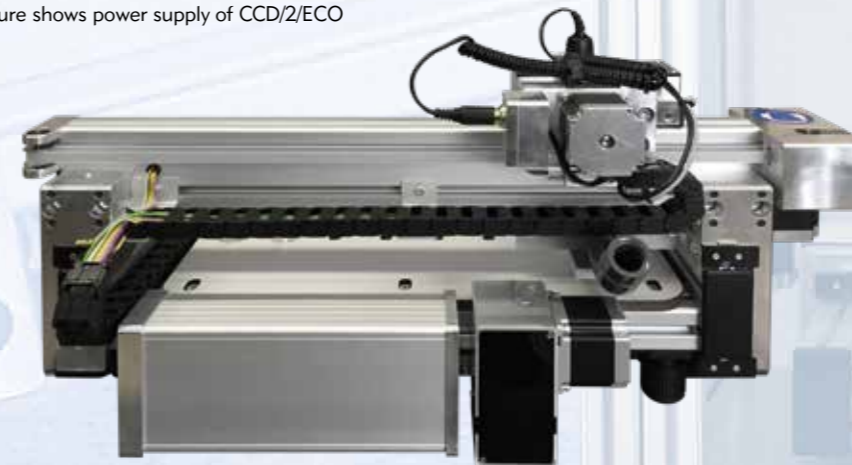

Picture shows rollrack

## BUNGARD CCD/2-ECO MTC

<b>Weight:</b>	30 kg
<b>Dimensions (LxWxH):</b>	700 x 550 x 300 mm
<b>Work area:</b>	270 x 325 x 38 mm
<b>Tool change:</b>	semiautomatic 99 tools
<b>Power supply:</b>	110-240 V, 50-60 Hz + vacuum cleaner (1500W) (not included in delivery)
<b>Range of RPM:</b>	5.000 – 35.000
<b>Traveling speed:</b>	1 – 9000 mm/min
<b>Software resolution:</b>	0,0001mm (0,1 µm)
<b>Mechanical resolution:</b>	step resolution: Software selectable: 1 mil, 1/2 mil, 1/4 mil, 1/8mil, optional: 1/16mil + 1/32mil
<b>Tool diameter:</b>	0.1mm – 3,175 mm (recommended, bigger tool diameter possible)
<b>Position accuracy:</b>	20 ppm (0.002%) over the entire work space:
<b>Maximum position speed per axis:</b>	9000/mm/min (= 150 mm/s)
<b>Maximum working speed per axis:</b>	9000/mm/min (= 150 mm/s), individual setting on a per-tool basis, independent from position speed
<b>Drill speed:</b>	5/s (= 9.000 holes/h= 150 holes/min)
<b>Required accessories:</b>	Computer
<b>Board fixation:</b>	span fixing, clamp fixing, reference pin system, stack processing possible Option: vacuum fixation

# BUNGARD CCD/2 MTC

## CNC MACHINE

The Bungard CCD/2/MTC is a high quality Computer Controlled Drilling machine with semi-automatic tool change. In contrast to the CCD/MTC the CCD/2 has a half sized work area (325 x 270 compared to 325 x 495mm) and an integrated control unit underneath the table.

Compared to the ATC models, the software interrupts the operation during the tool change and the new tool is changed manually (turning the knob changes by a quarter turn; motors remain empowered and hold the position).

The CCD/2 has the same robustness and precision as all the other CCD models. It is ideal as an entry-level model for isolation milling. If you want to operate the CCD/2 with cooling, you need to protect the control unit from the cooling. Please contact us beforehand.

In contrast to all other CCD models, the machine zero point is at the front left. The X axis is the traverse over the table, whereas the Y-axis is located on table level. The CCD/2 can not be converted to automatic tool change. If you possibly want to upgrade at a later time, please contact us before purchase. If necessary we can create a special version for you.

## SCOPE OF DELIVERY:

- Mechanic unit + control unit + complete cabling
- Superb and sturdy high frequency spindle with eddy current brake and load control
- Integrated mechanical milling depth limiter and pressure foot
- Driver software RoutePro3000 (Windows 7™-Windows 10™-64bit) for drilling and milling
- Powerful, adjustable (500-2000 W) vacuum cleaner + Start adapter for vacuum cleaner
- Manual, USB/serial adapter, Set of Allen Keys

**best choice for prototyping of printed circuit boards and isolation milling**

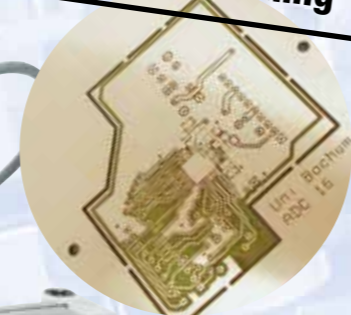

Picture of optional camera and LDI

## Available options:

Protective hood, CAM / Isolation software, monitor + camera, cooling device, compressor, etc.

## Explains:

MTC = Manual Tool Change  
ATC = Automatic Tool Change



Picture shows rollrack

## BUNGARD CCD/2 MTC

<b>Weight:</b>	30 kg
<b>Dimensions (LxWxH):</b>	700 x 550 x 300 mm
<b>Work area:</b>	270 x 325 x 38 mm
<b>Tool change:</b>	semiautomatic 99 tools
<b>Power supply:</b>	110-240 V, 50-60 Hz + vacuum cleaner (1500W)
<b>Range of RPM:</b>	5.000 – 63.000
<b>Traveling speed:</b>	1 – 9000 mm/min
<b>Software resolution:</b>	0,0001mm (0,1 µm)
<b>Mechanical resolution:</b>	step resolution: Software selectable: 1 mil, ½ mil, ¼ mil, 1/8 mil, optional: 1/16 mil + 1/32 mil
<b>Tool diameter:</b>	0.1mm – 3,175 mm (recommended, bigger tool diameter possible)
<b>Position accuracy:</b>	20 ppm (0.002%) over the entire work space:
<b>Maximum position speed per axis:</b>	9000/mm/min (= 150 mm/s)
<b>Maximum working speed per axis:</b>	9000/mm/min (= 150 mm/s), individual setting on a per-tool basis, independent from position speed
<b>Drill speed:</b>	5/s (= 18.000 holes/h= 300 holes/min)
<b>Required accessories:</b>	Computer
<b>Board fixation:</b>	span fixing, clamp fixing, reference pin system, stack processing possible Option: vacuum fixation



Videoclip of Bungard CCD

# BUNGARD CCD/2 ATC

## CNC MACHINE

The Bungard CCD/2/ATC is a high quality Computer Controlled Drilling machine with automatic tool change. The CCD/2/ATC differs from the CCD/ATC by a half sized working area (325 x 270mm).

The CCD/2/ATC is ideal for users, who do not have enough space to run an ATC machine..

## SCOPE OF DELIVERY:

- Mechanic unit + control unit + complete cabling
- Superb and sturdy high frequency spindle with eddy current brake and load control
- Integrated mechanical milling depth limiter and pressure foot
- Driver software RoutePro 3000 (Windows 7™-Windows 10™-64bit) for drilling and milling
- Powerful, adjustable (500-2000 W) vacuum cleaner + start adapter for vacuum cleaner
- Manual, USB/serial adapter, Set of Allen Keys
- ATC: Air hose

## Available options:

Protective hood, CAM / Isolation software, monitor + camera, cooling device, compressor, etc.

## Explains:

MTC = Manual Tool Change  
ATC = Automatic Tool Change

**best choice for  
prototyping of printed circuit  
boards and isolation milling  
small scale production**

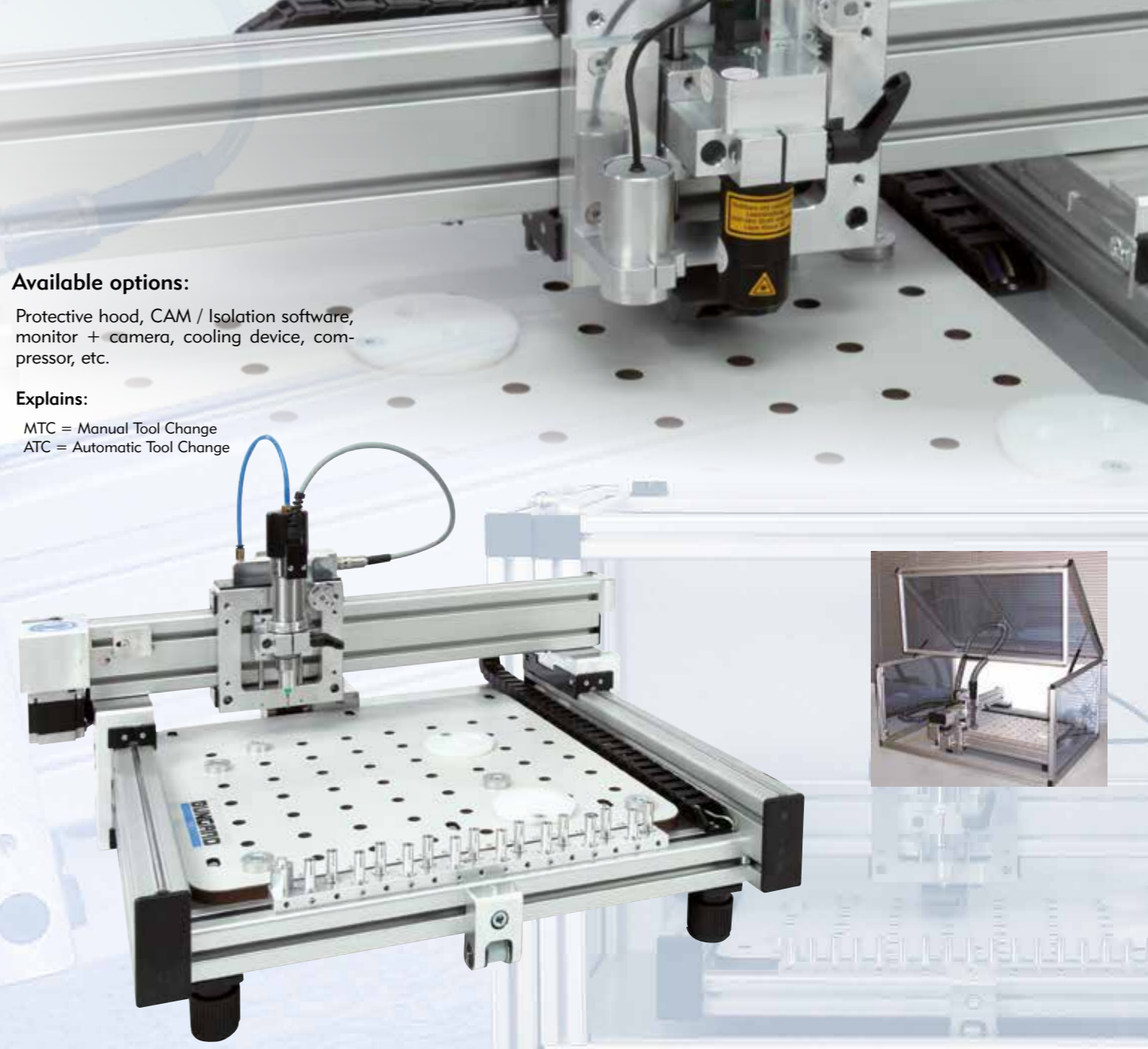
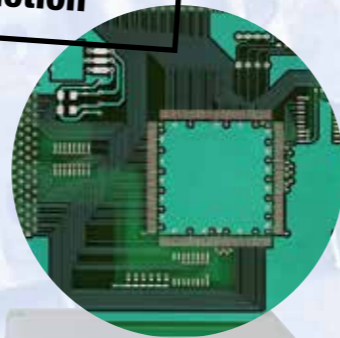
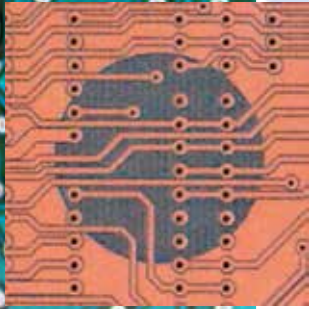

## BUNGARD CCD/2 ATC

<b>Weight:</b>	30 kg
<b>Dimensions (LxWxH):</b>	700 x 550 x 300 mm
<b>Work area:</b>	270 x 325 x 38 mm
<b>Tool change:</b>	16 automatic / semiautomatic 99 tools
<b>Power supply:</b>	110-240 V, 50-60 Hz + vacuum cleaner (1500W)
<b>Range of RPM:</b>	5.000 – 63.000
<b>Traveling speed:</b>	1 – 9000 mm/min
<b>Software resolution:</b>	0,00001 mm (0,01µm)
<b>Mechanical resolution:</b>	step resolution: Software selectable: 1 mil, 1/2 mil, 1/4 mil, 1/8 mil, optional: 1/16mil + 1/32mil
<b>Tool diameter:</b>	0.1 mm – 3,175 mm (recommended, bigger tool diameter possible)
<b>Position accuracy:</b>	20 ppm (0.002%) over the entire work space:
<b>Maximum position speed per axis:</b>	9000/mm/min (= 150 mm/s)
<b>Maximum working speed per axis:</b>	9000/mm/min (= 150 mm/s), individual setting on a per-tool basis, independent from position speed
<b>Drill speed:</b>	5/s (= 18.000 holes/h= 300 holes/min)
<b>Required accessories:</b>	Computer
<b>Board fixation:</b>	span fixing, clamp fixing, reference pin system, stack processing possible Option: vacuum fixation



Videoclip of Bungard CCD

# BUNGARD CCD/2 ATC PRECISION

## CNC MACHINE

The Bungard CCD/2/ATC Precision is a high quality Computer Controlled Drilling machine with automatic tool change. The CCD/2/ATC Precision differs from the CCD/2/ATC by higher step resolution at almost same drive speed as well as by two additional software packages under ROUTEPRO 3000:

Calibrate 3000 (incl. camera, not shown on the picture here) and PLUS 3000

The CCD/2/ATC Precision is ideal for users, who do not have enough space to run an CCD/Premium machine.

## SCOPE OF DELIVERY:

- Mechanic unit + control unit + complete cabling
- Superb and sturdy high frequency spindle with eddy current brake and load control
- Integrated mechanical milling depth limiter and pressure foot
- Driver software RoutePro 3000 (Windows 7™-Windows 10™-64bit) for drilling and milling
- Powerful, adjustable (500-2000 W) vacuum cleaner + start adapter for vacuum cleaner
- Manual, USB/serial adapter, Set of Allen Keys
- ATC: Air hose

## Available options:

Protective hood, CAM / Isolation software, monitor + camera, cooling device, compressor, etc.

## Explains:

MTC = Manual Tool Change  
ATC = Automatic Tool Change

**best choice for  
prototyping of printed circuit  
boards and isolation milling  
small scale production**

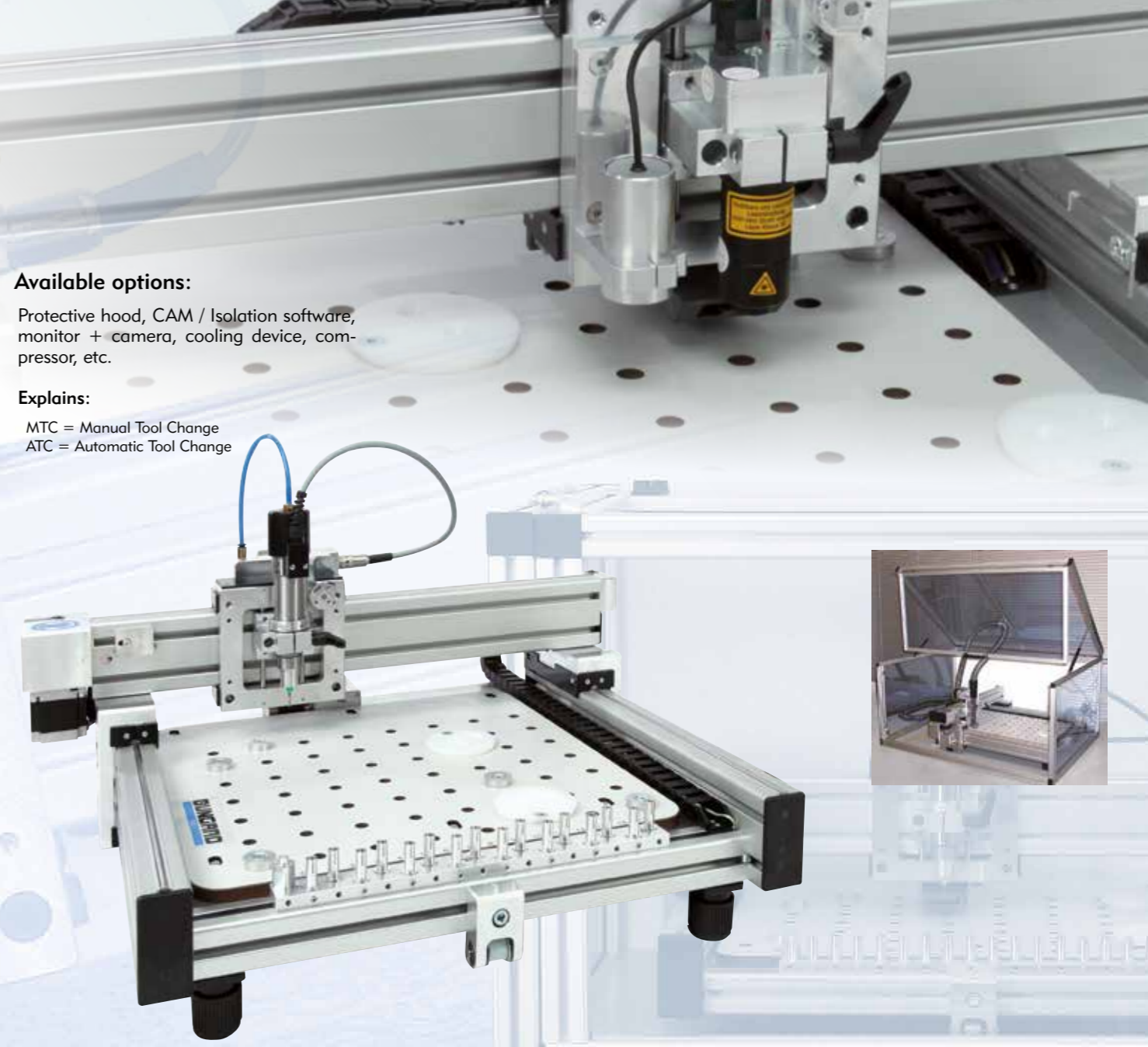

## BUNGARD CCD/2 ATC PRECISION

<b>Weight:</b>	30 kg
<b>Dimensions (LxWxH):</b>	700 x 550 x 300 mm
<b>Work area:</b>	270 x 325 x 38 mm
<b>Tool change:</b>	16 automatic / semiautomatic 99 tools
<b>Power supply:</b>	110-240 V, 50-60 Hz + vacuum cleaner (1500W)
<b>Range of RPM:</b>	5.000 – 63.000
<b>Traveling speed:</b>	1 – 7000 mm/min
<b>Software resolution:</b>	0,00001 mm (0,01µm)
<b>Mechanical resolution:</b>	step resolution: 0,79µm = 1/32 mil
<b>Tool diameter:</b>	0.1mm – 3,175 mm (recommended, bigger tool diameter possible)
<b>Position accuracy:</b>	20 ppm (0.002%) over the entire work space:
<b>Maximum position speed per axis:</b>	7000/mm/min (= 150 mm/s)
<b>Maximum working speed per axis:</b>	7000/mm/min (= 150 mm/s), individual setting on a per-tool basis, independent from position speed
<b>Drill speed:</b>	5/s (= 18.000 holes/h= 300 holes/min)
<b>Required accessories:</b>	Computer
<b>Board fixation:</b>	span fixing, clamp fixing, reference pin system, stack processing possible Option: vacuum fixation



Videoclip of Bungard CCD

# BUNGARD CCD MTC

## CNC MACHINE

The Bungard CCD/MTC is a high quality Computer Controlled Drilling and milling machine with semi-automatic tool change (MTC = manual tool change).

The CCD/MTC differs from the CCD/2 by a larger working area (325x495mm in contrast to 270x325mm) and by a separate controller.

Compared to the ATC models, the software interrupts the operation during the tool change and the new tool is changed manually (turning the knob changes by a quarter turn; motors remain empowered and hold the position).

With the sturdy spindle and the good fixation of the tool in the chuck the Bungard CCD / MTC is perfectly fitted for routing or engraving plastics, aluminium and other metals. 19 inch rack boards can also be processed.

## SCOPE OF DELIVERY:

- Mechanic unit + control unit + complete cabling
- Superb and sturdy high frequency spindle with eddy current brake and load control
- Integrated mechanical milling depth limiter and pressure foot
- Driver software RoutePro 3000 (Windows 7™-Windows 10™-64bit) for drilling and milling
- Powerful, adjustable (500-2000 W) vacuum cleaner + start adapter for vacuum cleaner
- manual, USB/serial adapter, Set of Allen Keys

**best choice for printed circuit boards and frontpanel production**

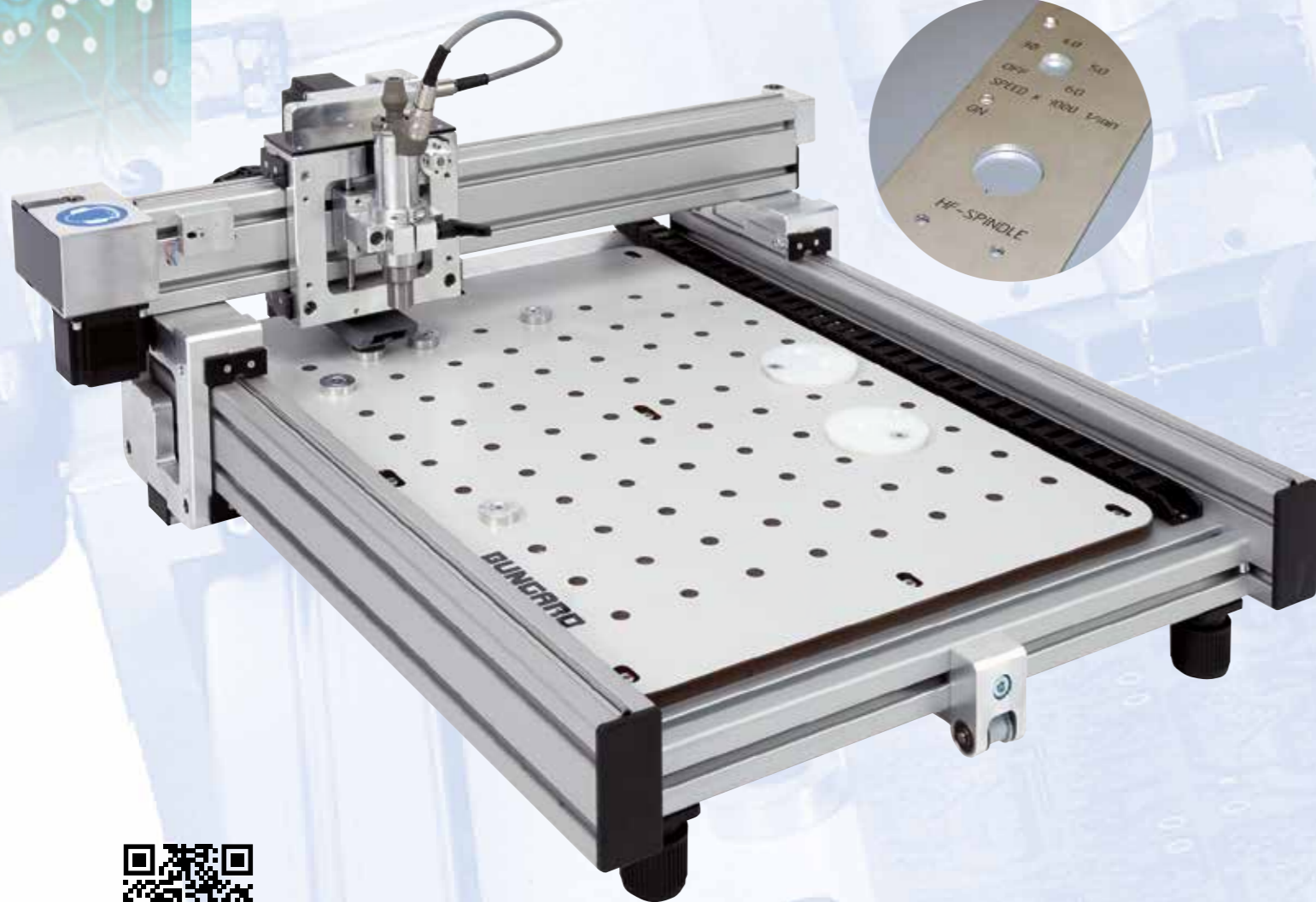

## Available options:

Protective hood, CAM / Isolation software, monitor + camera, cooling device, compressor, etc.

## Explains:

MTC = Manual Tool Change  
ATC = Automatic Tool Change

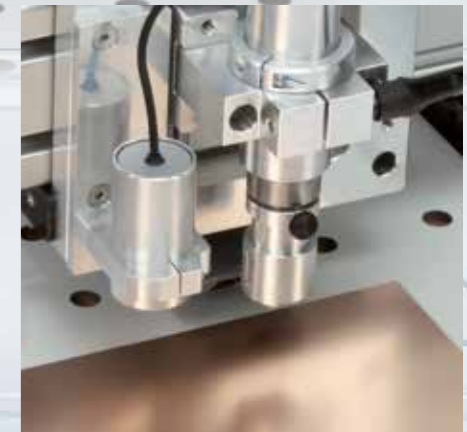

Option: Camera

## BUNGARD CCD MTC

<b>Weight:</b>	35 kg
<b>Dimensions (LxWxH):</b>	700 x 800 x 300 mm
<b>Work area:</b>	325 x 495 x 38 mm
<b>Tool change:</b>	semiautomatic 99 tools
<b>Power supply:</b>	110-240 V, 50-60 Hz + vacuum cleaner (1500W)
<b>Range of RPM:</b>	5.000 – 63.000
<b>Traveling speed:</b>	1 – 9000 mm/min
<b>Software resolution:</b>	0,00001mm (0,01µm)
<b>Mechanical resolution:</b>	step resolution: Software selectable: 1 mil, 1/2 mil, 1/4 mil, 1/8mil, optional: 1/16mil + 1/32mil
<b>Tool diameter:</b>	0.1 mm – 3,175 mm (recommended, bigger tool diameter possible)
<b>Position accuracy:</b>	20 ppm (0.002%) over the entire work space:
<b>Maximum position speed per axis:</b>	9000/mm/min (= 150 mm/s)
<b>Maximum working speed per axis:</b>	9000/mm/min (= 150 mm/s), individual setting on a per-tool basis, independent from position speed
<b>Drill speed:</b>	5/s (= 18.000 holes/h= 300 holes/min)
<b>Required accessories:</b>	Computer
<b>Board fixation:</b>	span fixing, clamp fixing, reference pin system, stack processing possible Option: vacuum fixation



Videoclip of Bungard CCD

# BUNGARD CCD ATC

## CNC MACHINE

The Bungard CCD/ATC is a high quality Computer Controlled Drilling machine with Automatic Tool Change (ATC).

The ATC as well as all other CCDs allows directly processing of Excellon / Sieb&Meyer drill data or HP/GL route data for producing pcbs (drilling, cut-out-routing, isolation milling) or routing/engraving plastics, aluminium and other metals.

The CCD/ATC differs from the CCD/MTC by the automatic 16-slot tool changer. The work space is the same. Compared with the CCD/2 the ATC has a larger work space (325x495mm in contrast to 270x325mm with the CCD/2) and a separate control unit.

The ATC is ideal for big and more complex PCBs with many different drill sizes. 19 inch rack boards can also be processed.

## SCOPE OF DELIVERY:

- Mechanic unit + control unit + complete cabling
- Superb and sturdy high frequency spindle with eddy current brake and load control
- Integrated mechanical milling depth limiter and pressure foot
- Driver software RoutePro 3000 (Windows 7™-Windows 10™-64bit) for drilling and milling
- Powerful, adjustable (500-2000 W) vacuum cleaner + start adapter for vacuum cleaner
- Manual, USB/serial adapter, Set of Allen Keys
- ATC: Air hose

## Available options:

Protective hood, CAM / Isolation software, monitor + camera, cooling device, compressor, etc.

## Explains:

MTC = Manual Tool Change  
ATC = Automatic Tool Change

**best choice for  
PCB production in  
large quantities**

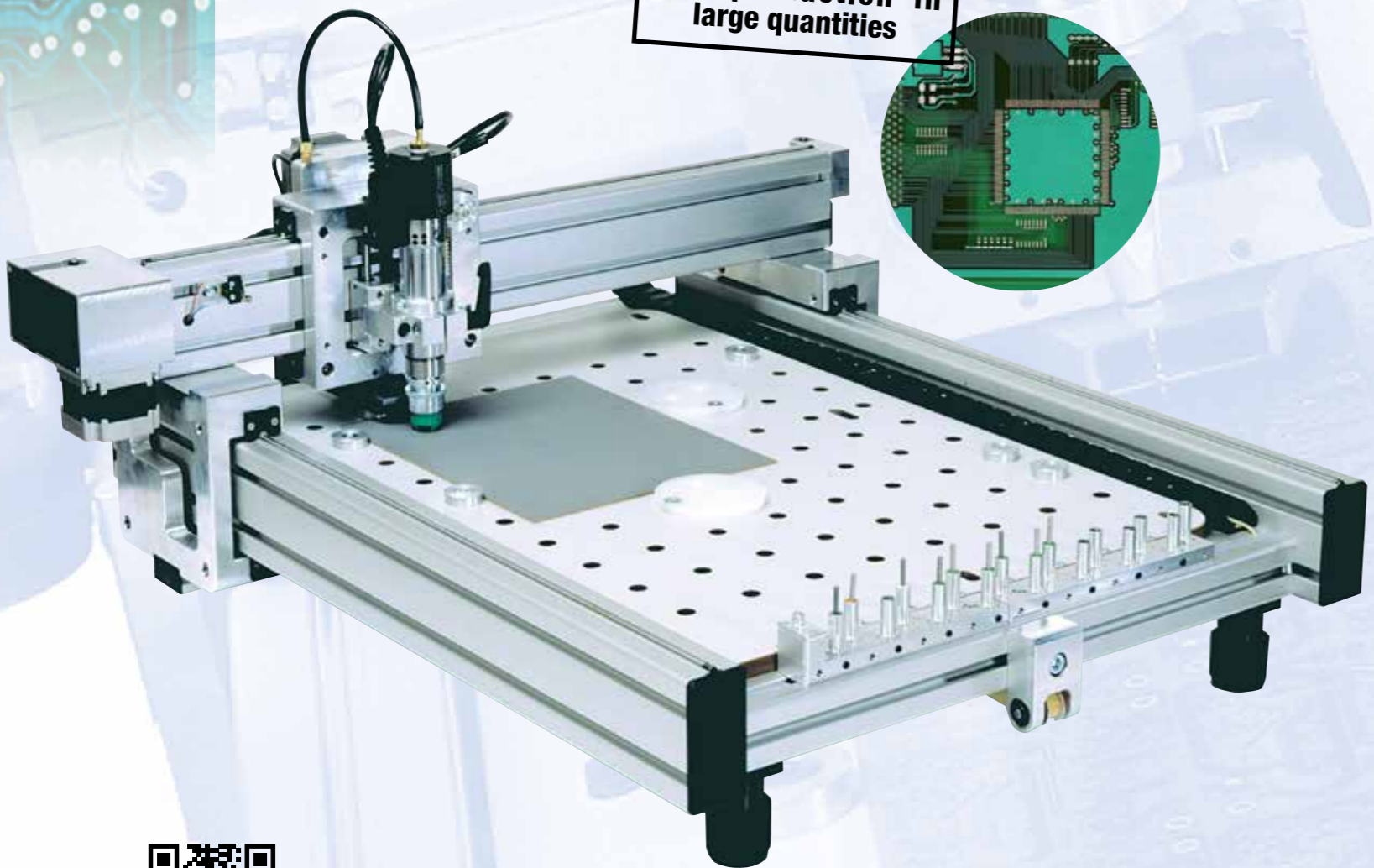
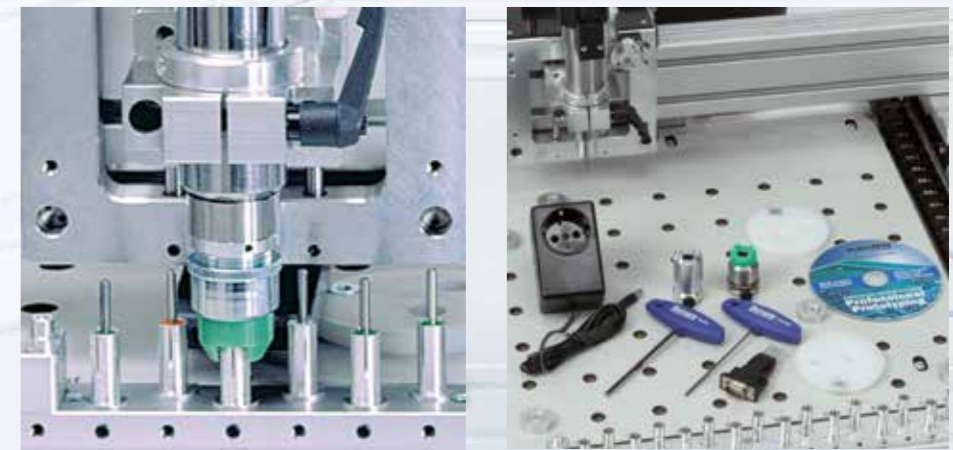
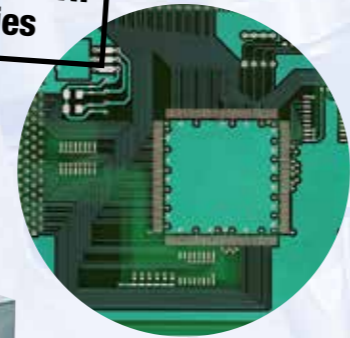

BUNGARD CCD ATC	
<b>Weight:</b>	35 kg
<b>Dimensions (LxWxH):</b>	700 x 800 x 300 mm
<b>Work area:</b>	325 x 495 x 38 mm
<b>Tool change:</b>	16 automatic / semiautomatic 99 tools
<b>Power supply:</b>	110-240 V, 50-60 Hz + vacuum cleaner (1500W)
<b>Range of RPM:</b>	5.000 – 63.000
<b>Traveling speed:</b>	1 – 9000 mm/min
<b>Software resolution:</b>	0,00001mm (0,01µm)
<b>Mechanical resolution:</b>	step resolution: Software selectable: 1 mil, 1/2 mil, 1/4 mil, 1/8mil, optional: 1/16mil + 1/32mil
<b>Tool diameter:</b>	0.1 mm – 3,175 mm (recommended, bigger tool diameter possible)
<b>Position accuracy:</b>	20 ppm (0.002%) over the entire work space:
<b>Maximum position speed per axis:</b>	9000/mm/min (= 150 mm/s)
<b>Maximum working speed per axis:</b>	9000/mm/min (= 150 mm/s), individual setting on a per-tool basis, independent from position speed
<b>Drill speed:</b>	5/s (= 18.000 holes/h= 300 holes/min)
<b>Required accessories:</b>	Computer
<b>Board fixation:</b>	span fixing, clamp fixing, reference pin system, stack processing possible Option: vacuum fixation



Videoclip of Bungard CCD



# BUNGARD CCD XL MTC

## CNC MACHINE

The Bungard CCD/MTC is a high quality Computer Controlled Drilling and milling machine with semi-automatic tool change (MTC = manual tool change).

The CCD/MTC XL differs from the CCD/MTC by a larger working area (500x600mm in contrast to 325x495mm).

Compared to the ATC models, the software interrupts the operation during the tool change and the new tool is changed manually (turning the knob changes by a quarter turn; motors remain empowered and hold the position).

With the sturdy spindle and the good fixation of the tool in the chuck the Bungard CCD/MTC XL is perfectly fitted for routing or engraving plastics, aluminium and other metals. 19 inch rack boards can also be processed.

## SCOPE OF DELIVERY:

- Mechanic unit + control unit + complete cabling
- Superb and sturdy high frequency spindle with eddy current brake and load control
- Integrated mechanical milling depth limiter and pressure foot
- Driver software RoutePro 3000 (Windows 7™-Windows 10™-64bit) for drilling and milling
- Powerful, adjustable (500-2000 W) vacuum cleaner + start adapter for vacuum cleaner
- Manual, USB/serial adapter, Set of Allen Keys



**best choice for printed circuit boards in large quantities and front-panel production**

## Available options:

Protective hood, CAM / Isolation software, monitor + camera, cooling device, compressor, etc.

## Explains:

MTC = Manual Tool Change  
ATC = Automatic Tool Change

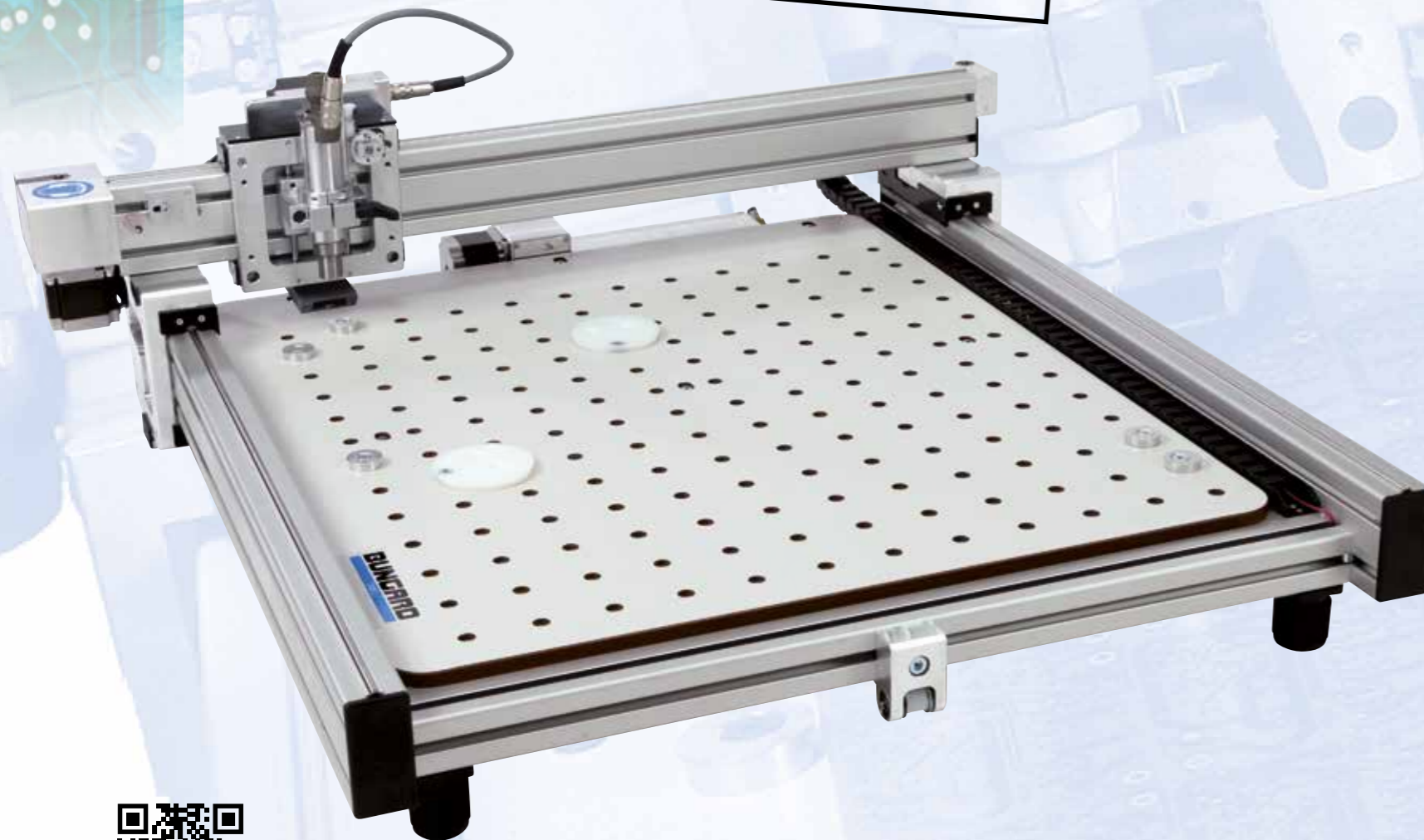
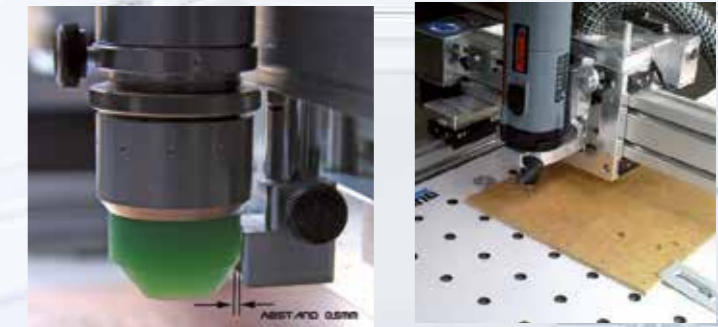

BUNGARD CCD XL MTC	
<b>Weight:</b>	49 kg
<b>Dimensions (LxWxH):</b>	950 x 950 x 300 mm
<b>Work area:</b>	500 x 600 x 38 mm
<b>Tool change:</b>	semiautomatic 99 tools
<b>Power supply:</b>	110-240 V, 50-60 Hz + vacuum cleaner (1500W)
<b>Range of RPM:</b>	5.000 – 63.000
<b>Traveling speed:</b>	1 – 9000 mm/min
<b>Software resolution:</b>	0,00001mm (0,01µm)
<b>Mechanical resolution:</b>	step resolution: Software selectable: 1 mil, 1/2 mil, 1/4 mil, 1/8mil, optional: 1/16mil + 1/32mil
<b>Tool diameter:</b>	0.1 mm – 3,175 mm (recommended, bigger tool diameter possible)
<b>Position accuracy:</b>	20 ppm (0.002%) over the entire work space:
<b>Maximum position speed per axis:</b>	9000/mm/min (= 150 mm/s)
<b>Maximum working speed per axis:</b>	9000/mm/min (= 150 mm/s), individual setting on a per-tool basis, independent from position speed
<b>Drill speed:</b>	5/s (= 18.000 holes/h= 300 holes/min)
<b>Required accessories:</b>	Computer
<b>Board fixation:</b>	span fixing, clamp fixing, reference pin system, stack processing possible Option: vacuum fixation



Videoclip of Bungard CCD

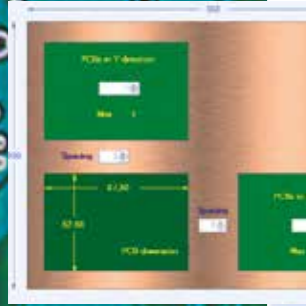

# BUNGARD CCD XL ATC

## CNC MACHINE

The Bungard CCD/ATC/XL is a high quality Computer Controlled Drilling machine with Automatic Tool Change (ATC).

The ATC/XL as well as all other CCDs allows directly processing of Excellon / Sieb&Meyer drill data or HP/GL route data for producing PCBs (drilling, cut-out-routing, isolation milling) or routing/engraving plastics, aluminium and other metals.

The CCD/ATC/XL differs from the CCD/MTC/XL by the automatic 25-slot tool changer. The work space is the same.

Compared with the CCD/ATC the XL has a larger work space (500x600mm in contrast to 495x325mm with the CCD/ATC) and the number of tool slots (25 instead of 16).

The ATC is ideal for very big and complex PCBs with many different drill sizes and for special applications.

## SCOPE OF DELIVERY:

- Mechanic unit + control unit + complete cabling
- Superb and sturdy high frequency spindle with eddy current brake and load control
- Integrated mechanical milling depth limiter and pressure foot
- Driver software RoutePro 3000 (Windows 7™-Windows 10™-64bit) for drilling and milling
- Powerful, adjustable (500.-2000 W) vacuum cleaner + start adapter for vacuum cleaner
- Manual, USB/serial adapter, Set of Allen Keys
- ATC: Air hose

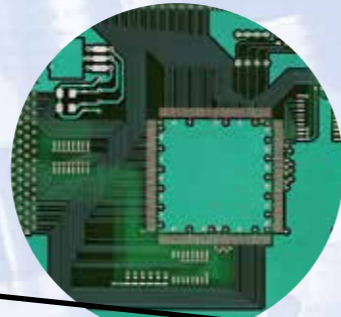

**best choice for  
PCB production in large  
quantities**

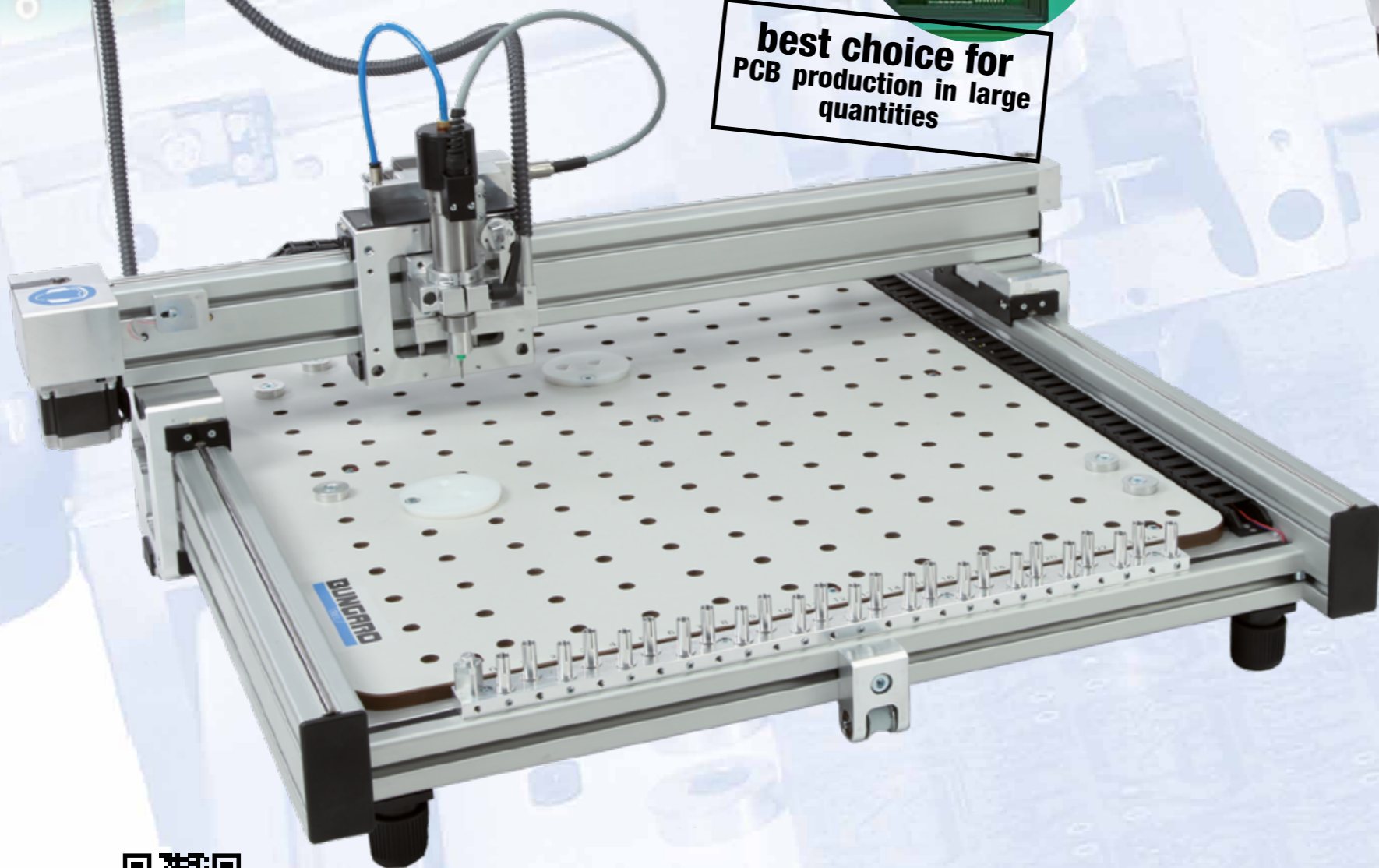

## Available options:

Protective hood, CAM / Isolation software, monitor + camera, cooling device, compressor, etc.

## Explains:

MTC = Manual Tool Change  
ATC = Automatic Tool Change



## BUNGARD CCD XL ATC

<b>Weight:</b>	49 kg
<b>Dimensions (LxWxH):</b>	950 x 950 x 300 mm
<b>Work area:</b>	500 x 600 x 38 mm
<b>Tool change:</b>	25 automatic / semiautomatic 99 tools
<b>Power supply:</b>	110-240 V, 50-60 Hz + vacuum cleaner (1500W)
<b>Range of RPM:</b>	5.000 – 63.000
<b>Traveling speed:</b>	1 – 9000 mm/min
<b>Software resolution:</b>	0,00001mm (0,01µm)
<b>Mechanical resolution:</b>	step resolution: Software selectable: 1 mil, 1/2 mil, 1/4 mil, 1/8mil, optional: 1/16mil + 1/32mil
<b>Tool diameter:</b>	0.1 mm – 3,175 mm (recommended, bigger tool diameter possible)
<b>Position accuracy:</b>	20 ppm (0.002%) over the entire work space:
<b>Maximum position speed per axis:</b>	9000/mm/min (= 150 mm/s)
<b>Maximum working speed per axis:</b>	9000/mm/min (= 150 mm/s), individual setting on a per-tool basis, independent from position speed
<b>Drill speed:</b>	5/s (= 18.000 holes/h= 300 holes/min)
<b>Required accessories:</b>	Computer
<b>Board fixation:</b>	span fixing, clamp fixing, reference pin system, stack processing possible Option: vacuum fixation



Videoclip of Bungard CCD

# BUNGARD CCD PREMIUM

## CNC PREMIUM MACHINE

An international trendsetter on the world market for printed circuit board production is the **Bungard CCD PREMIUM**.

It combines all available highlights, required in a modern PCB lab, to a fully equipped CNC center.

### Details:

- Highest possible speed of **22m/minute / standard 7m/min**
- Extremely high **step resolution of 0,79 µm**.
- **32 Bit chip technology** for extremely quick communication under Windows 10™ (or higher)
- **Direct USB Port** for easy installation
- High precision aluminium table, double sided overmilled, for about zero height tolerance
- Low maintenance costs due to linear belt drive in x- and y- direction

### Standard features:

- Two synchron, in parallel working stepper motors for X-axis for max possible stiffness
- 100.000 1/min spindle for smallest tool diameters
- 300 W spindle
- Stepper motor torque adjustable via **software**
- **30 tool boxes** for automatic tool change
- Tool length measurement and calibration incl. tool break control
- Integral pressure foot and depth limiter system
- Dust extraction with autostart function via software
- Rollrack with transparent doors with security switches

### Standard software supplied with the system:

- Software resolution 0,1µm
- LOG files for perfect and automated online support.
- **ROUTEPRO 3000** inclusive all modules:
  - Plus 3000
  - LaserPro 3000
  - DispPro 3000
  - Dokument 3000
  - Calibrate 3000
  - Inspect 3000

### Technical details/requirements:

Power supply: 90-250 V AC /47-63 Hz or 124-370V DC (without options and dust extraction)  
 Compressed air: 6 bar, +- 40 liter/minute  
 Dimensionen machine: +- 800 x 950 x 600 mm  
 Board size: 400 x 500 mm (Z-max: 64 mm)  
 Weight machine: +- 80 kg  
 Dimensionen rack: +- 900 x 1100 x 1600 mm  
 Weight rack: +- 100 kg

### Available options:

- Laser head for LDI
- Dispenser
- Super silent compressor
- Vacuum table

**Note:** Computer does not belong to scope of delivery.

For latest details scan QR-Code or look at BUNGARD website:



[www.bungard.com](http://www.bungard.com)  
 Bungard CCD Premium

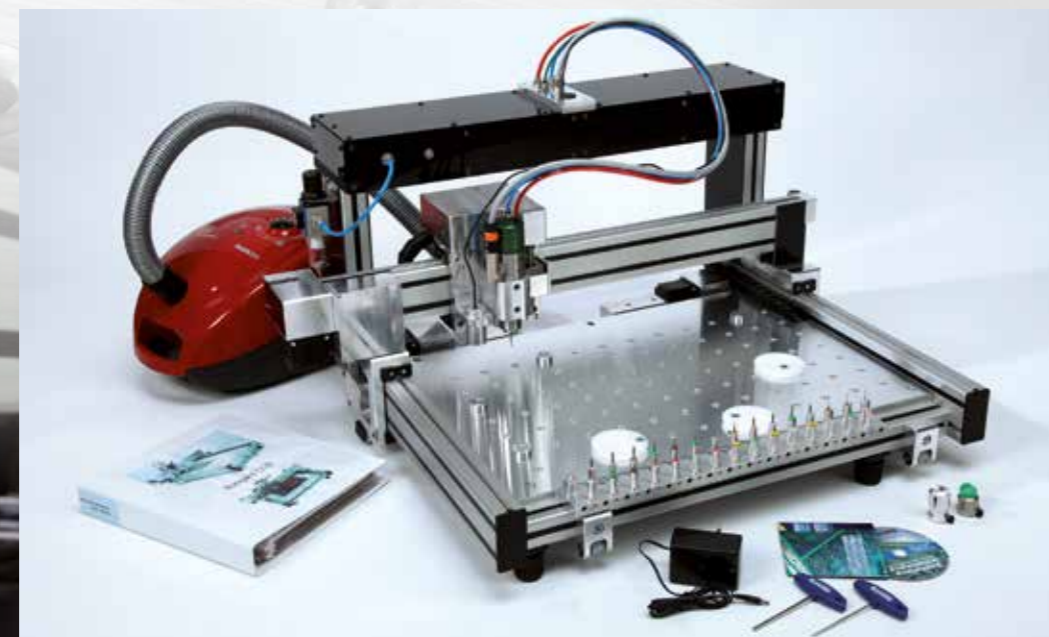

**best choice for**  
**PCB production in large scale**  
 and with very fine tools or Laser Direct  
 Imaging in high resolution e.g. in HF  
 application

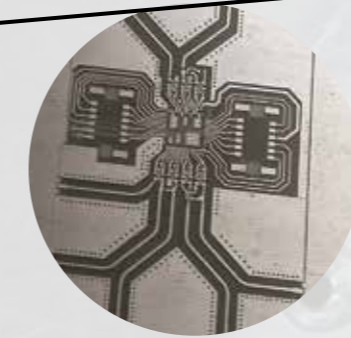

# CCD ACCESSORIES

## HARDWARE

The CCD is extensible through a variety of options, such as:

Protective hood, CAM/Isolation software, monitor + camera, cooling device, compressor, etc.

## SOFTWARE

Bungard standard software **RoutePro3000** can be expanded with additional software modules, such as::

**LaserPro 3000, DispPro 3000, Calibrate 3000, Inspect 3000, Document 3000, Plus 3000, API 3000 and QR-Code 3000**

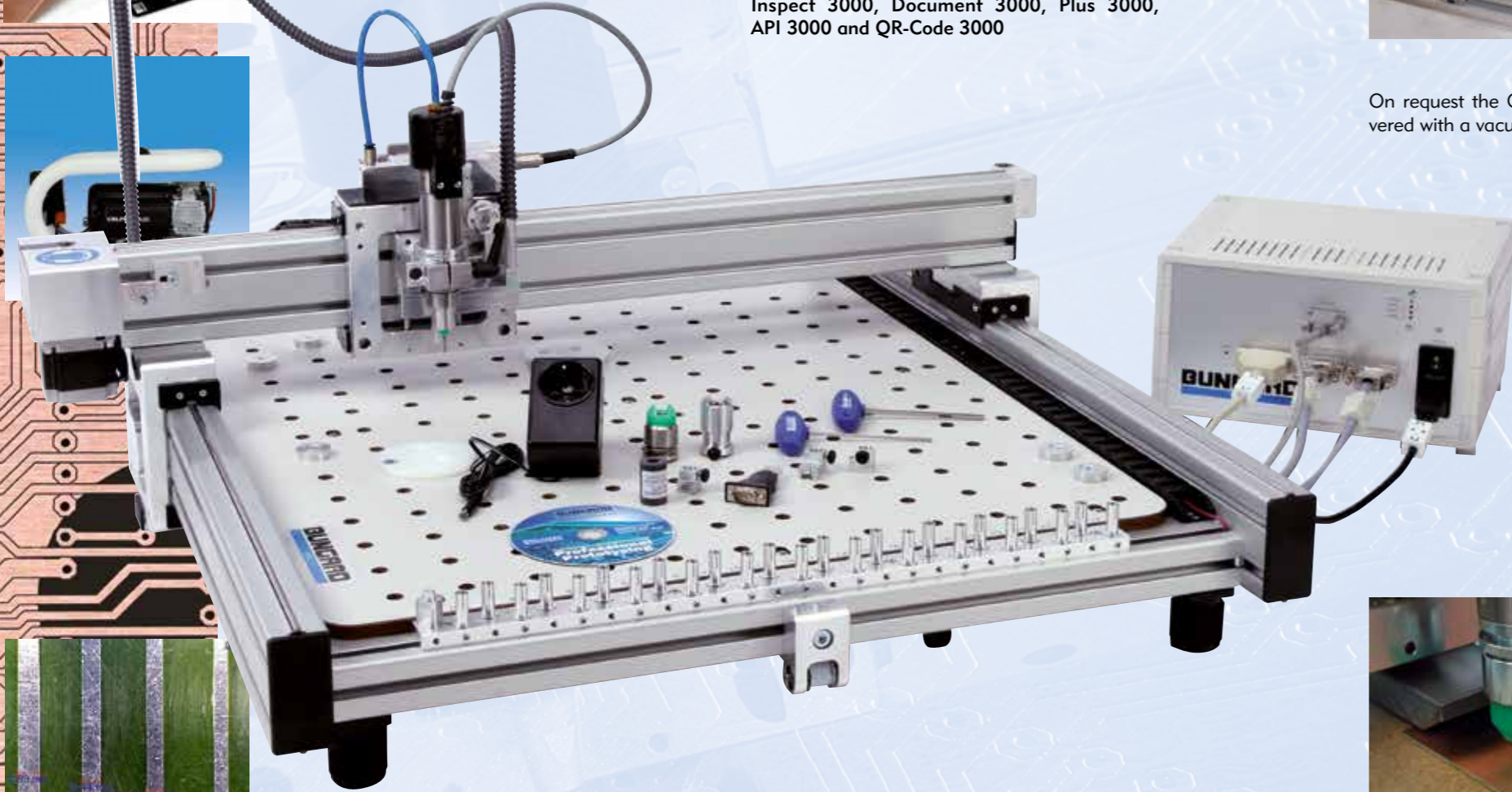

### Starter Kit for Bungard CCD

To work directly with your Bungard CCD, some accessories are required. For our new customers we arranged a starter kit according to our experience.



On request the CCD is delivered with a vacuum table.



For dust and noise protection we offer sound-proofing hoods and racks.

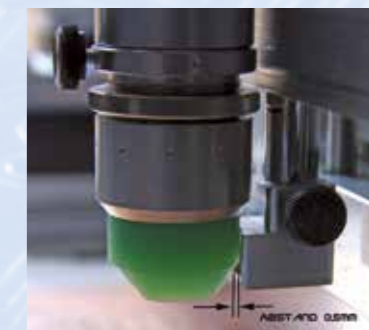

Optional enhanced dust extraction system (instead of standard nozzle) offers

- higher efficiency
- lower noise
- more effective travel height



One integral part of the CCD is to keep it multifunctional.

Exchanging the high frequency spindle with a pen plot adapter changes the CCD into an A3 Pen plotter.



Depth limiter.



Pressure foot for drilling and routing.

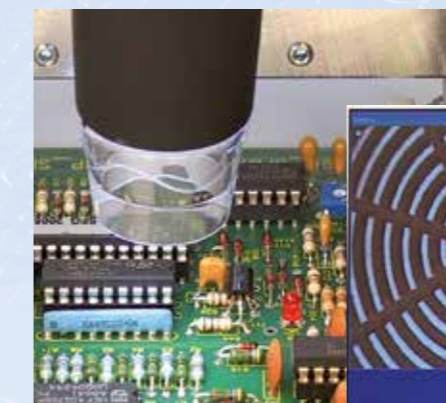

The USB camera will allow optical inspection of your board.

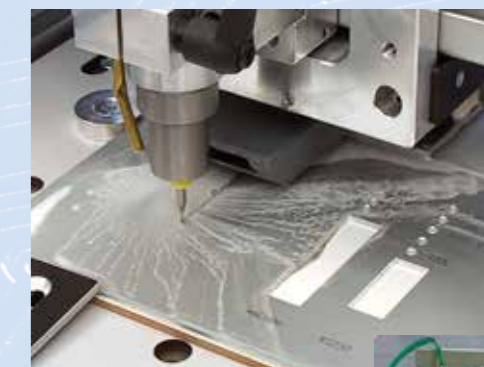

With few steps you can equip the CCD with a coolant supply.



# ROUTEPRO 3000

TOP EQUIPMENT:  
SERIES OR UPGRADE  
THE CNC SOFTWARE-PLATFORM

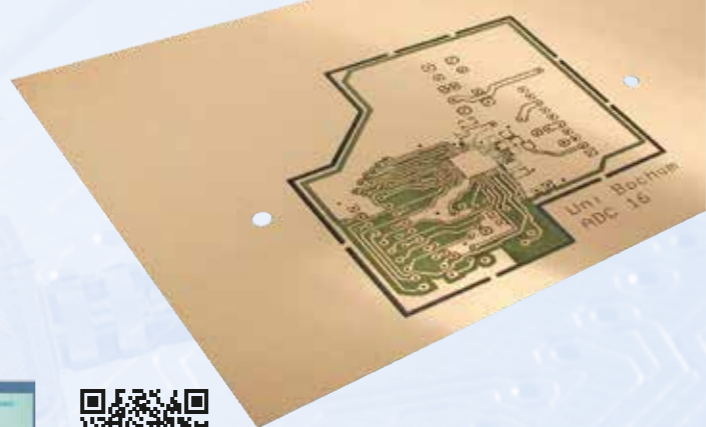

The design concept of Routepro 3000 computer-aided manufacturing (CAM) tool is to operate the BUNGARD CNC hardware. This will enable you to run the software on your CAD computer in your R&D department or on any other separate computer in a production plant. As you like.

That meets the requirements of the modern workplace. The designer can finish the prototype straight away himself or start the next CAD job, e.g. with ISOCAM 5.0 and pass the PCB production to a machine operator. That way your Bungard CCD in combination with Routepro 3000 is used for large scale production of printed circuit boards.

You will be supported by a wizard that leads through the project and of course by an online help function.

### FEATURES:

- Modern optics with Windows 10™ ribbon bar, floating or docking windows
- Machine and tool parameters are stored job related
- A wizard ensures that all tools are properly provided with parameters
- Tool parameters can be stored according to material and router or drill type
- Language module for easy translation
- Machine configuration graphically interactive
- In the standard RoutePro 3000 up to 4 files are read in at the same time; e.g. reference holes, drill file, milling file top and milling file bottom.
- Detailed online help with step-by-step instructions
- Units can be switched from inches to metric
- Log files for easy online support !
- All parameters (speeds, scaling, offset, etc.) configurable.

Designed as software package for all BUNGARD CCD CNC systems (later than 2006),

RoutePro 3000 integrates all standard functionality of previous Bungard software platforms such as:

- Drilling and routing of circuit boards
- Isolation milling and engraving
- Routing and engraving of front panels and housings
- Production of SMD templates

in a free of charge basic tool. This basic functionality may be upgraded at any time to various other applications by these interesting

### MODULES:

- **Plus 3000** for up to 32 layers at a time
- **LaserPro 3000** for laser direct imaging of photoresists
- **DispPro 3000** for line and dot dispensing and filling
- **Document 3000** for work protocol as .pdf document
- **Calibrate 3000** for fiducial recognition with camera
- **Inspect 3000** for automated optical inspection (AOI)
- **API 3000** for remote control and connection to your own applications
- **QR-Code 3000** for easy documentation

For detailed description see following pages.

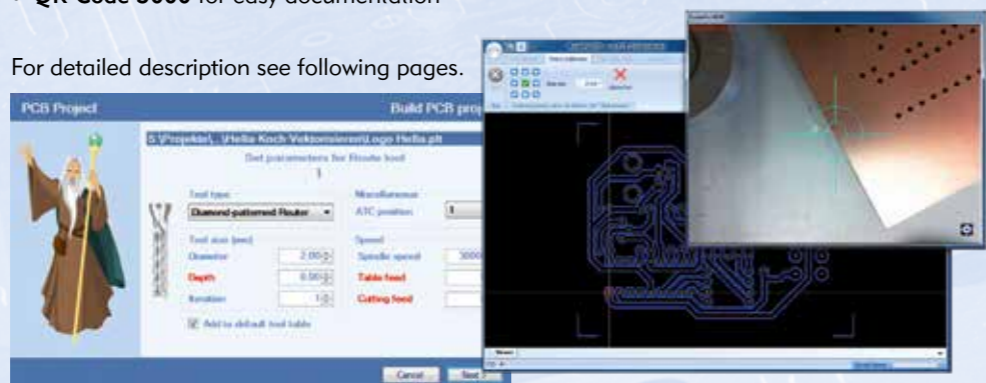

- Spindle speed setting by software from 30000-63000 1/min (5.000 - 100.000 1/min for CCD Premium)
- Inclusive spindle quick stop
- Support of manual tool change (MTC) or automatic tool change (ATC)
- Drilling and routing diameters > 0.1 mm
- Driver software for Excellon, Sieb & Meyer or HP / GL data on Windows XP .... Windows 10™ (32 - or 64-bit) with convenient user interface
- Improved tool-statistics with parameters for up to 99 tools
- Screen presentation of milling vectors and drill holes
- Selection of vectors to be processed + drill holes using the mouse on the screen
- Working progress indicator on the screen
- Milling and drill files can be simultaneously loaded and executed successively by simply switching the file.
- Real-time capability with handshake on work progress for controlled operation and stops.
- In combination with optional USB CAMERA, picture is displayed on the computer screen with a crosshairs target.
- For upgrade of machines elder than 2006, we can convert the controller of the CCD.



# CCD OPTIONS

## Plus 3000 Bungard extra modul



With this module activated you will get the following extra features:

- You may load up to 32 layers per project !
- In the Wizard you may select the type of project, depending on your selection, the project will be stored under the project type name. This can be useful to separate projects meant for PCB or stencils etc.
- You may position the machine by moving and clicking with the mouse in the camera screen. It will also try to center the drill hole. This can be useful if you want to capture the holes from an existing PCB.
- Under the tab GENERAL you may set the origin of your material. This can be the zero position of machine but can also be calculated from the material position.
- Under the Views tab you now have the following extra's:
  - Show material
  - Set the intensity of the line grid
  - Set the intensity of the dot grid
  - Set the intensity of the table view
  - Show the mounting holes
  - Show the ATC tool-slots and depth sensor
- Under the Help tab you'll find two buttons to open the location of the current project and the documentation.

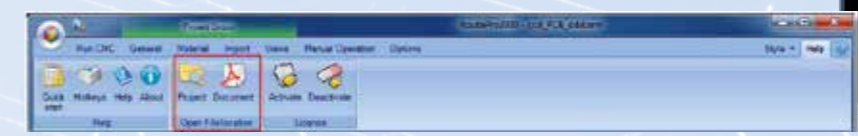

## CCD OPTIONS

### LaserPro 3000 Bungard Laser Module

The Bungard laser unit is an add-on-item for the Bungard CCD to expose photoresists, solder masks and Alucorex. The laser is mounted into the spindle holder instead of the high frequency spindle and is controlled by the RoutePro 3000 software.



The Bungard laser exposure unit is an answer to the demand of many operators for higher precision, faster processing speeds and reduced tool costs compared to other technologies as for example isolation milling.

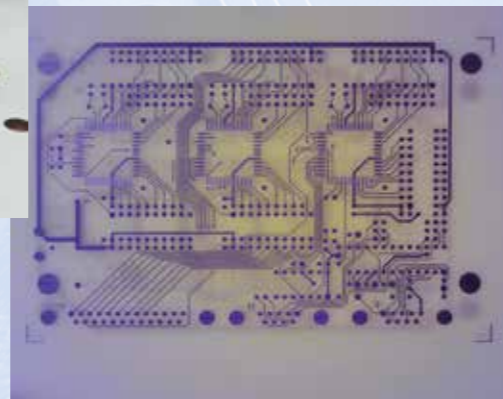
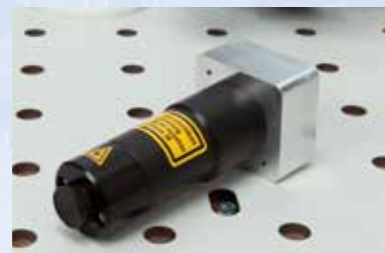

### LASERPRO 3000

<b>Laser class:</b>	class 3B
<b>Power:</b>	120mW
<b>Dimensions (LXBXH):</b>	47 x 47 x 110 mm
<b>Safety:</b>	Magnetic safety switch, laser turns on only when laser is mounted facing down into the CCD holder PVC housing
<b>Power connection:</b>	Via Bungard CCD
<b>Application:</b>	Via Bungard CCD/RoutePro3000

### DispPro 3000 Bungard Dispensing Module



The dispensing module DispPro 3000 is an extension of the CCD for dispensing solder paste or glue.

Instead of being controlled by a foot switch, a pneumatic manual dispensing unit is controlled over the software modul DispPro 3000. A dosing cartridge of the dispenser is mounted into the holder of the high-frequency spindle.

The module is not a fully automatic dispensing unit, but a dosing aid for a manual dispenser.

The machine drives precisely to each dosing point and dosing time dosing height are precisely controlled.

Further settings like viscosity control and control of the dosing volume are not supported. The control of these parameters is subject to the user.

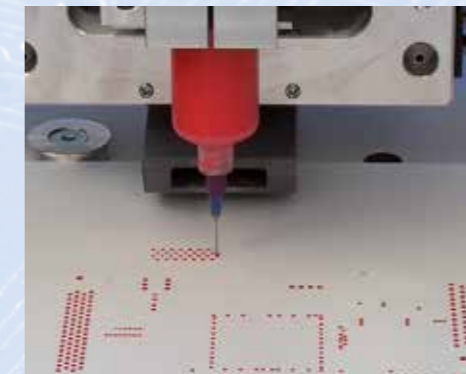

### DISPPRO 3000

<b>Dimensions:</b>	220 x 210 x 67 mm
<b>Weight:</b>	1 kg
<b>Input Voltage:</b>	100 – 240 VAC
<b>Internal Voltage:</b>	24 VDC
<b>Air inlet:</b>	5-7 bar
<b>Air outlet:</b>	0, 1-7 bar
<b>Hold back vacuum:</b>	Non-Drop System
<b>Control:</b>	Via Bungard CCD/RoutePro3000
<b>Requirements:</b>	Bungard CCD Dispensing license DispPro3000 for Route-Pro3000
<b>Application:</b>	connection to compressed air Dosing of solder paste and glue

### Calibrate 3000 Bungard Calibration Module



With the calibration module, you can visually calibrate the position of your board. The software moves and rotates the board according to the actual position of the calibration marks or registration holes.

For this purpose, the machine automatically drives to certain fiducial registration points on the layout and the user centers the cross mark of the camera over the mark and acknowledges the position. Registration holes can be easily inserted e.g. with IsoCam. Height calibration is also possible with the help of standardized templates.

The calibration function is useful if you e.g. do not want to work with reference pins for double-sided boards, or the board has been changed by other process steps (pressing multilayer, galvanic through hole plating), so the reference pins may lead to inaccuracies.

Another typical application is the rework, e.g. if after components assembly the circuit board can no longer be fixed with reference pins to the base.

Rework could also be:

- You received a board from a customer and the adjustment holes of the board are too small and you need to drill them with a bigger tool

- You have a dispense unit installed and want to calibrate the PCB, so the dots will be placed correctly
- You want to cut a hole in a PCB that was already finished.
- You want e.g. calibrate a possible offset between drilling-/milling spindle to a dosing needle or the laser exposure head.

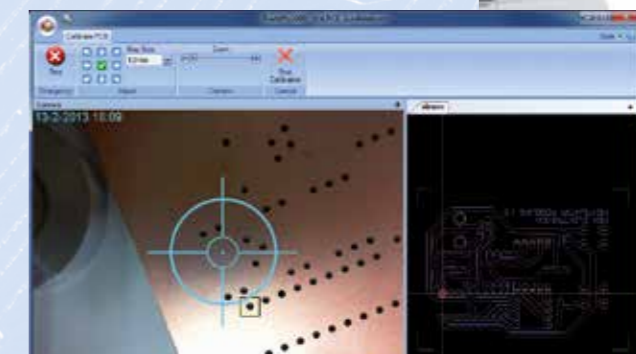

### CALIBRATE 3000

<b>Application:</b>	<b>Fiducial recognition</b> for PCB inspection, Machine calibration
<b>Scope of delivery:</b>	Camera with USB-cable, holder to connect camera to CCD, possibly an active usb-extension is needed. This is not part of delivery.
<b>Features:</b>	HD-Video with 720p, Autofocus, high precision lens with glass elements delivers sharp image quality, TrueColor-Technology, automatic exposure for brilliant videos in vivid colours. HD video recording at 720p, records up to 30 pictures per second in real HD quality. Clear Frame-Technology: exceptional even in low light conditions for smooth, detailed videos Optimized for Windows 10. Quick set-up, no driver installation required.
<b>System requirements:</b>	Windows 10, Windows 7, Windows Vista, Windows XP (SP2) or higher (exception Windows XP 64-Bit). At least: Intel Dual-Core 1,6 GHz or higher , 1 GB RAM. Recommended: Intel Dual-Core 3,0 GHz or higher, 2 GB RAM USB 2.0, Hard disc: 1,5 GB of free storage

# CCD OPTIONS

## Inspect 3000 Bungard Inspection Module

With this module you can use a Bungard CCD for AOI-drives (Automatic Optical Inspection).

If you have started Inspect3000, the machine will travel to the first drill position and waits there, so you have time to look at this position closely. If you press start, the next position will be shown.

Note: This function will only work on drill layers.

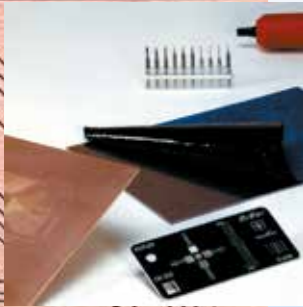

## Document 3000 Bungard Documentation Module

This documentation module will provide outstanding documentation which you can use for future reference. You may also handout the project documentation to your customer along with the finished boards.

When the documentation module is activated you'll find a new button under options: PDF

Pressing this button will generate a complete PDF document, containing all the machine settings. This includes activated licenses, correction factors, serial numbers, tool defaults for routers, drills, laser and dispense tools and many more.



3. XY Motor	
<b>Speed Setting</b>	
Max. speed	9000
Reference	800
<b>Start/stop Speed</b>	
Start/Stop	800
Ramp steps	3
4. Z Motor	
<b>Speed Setting</b>	
Max. speed	8250
Reference	1000
<b>Start/stop Speed</b>	
Start/Stop	900
Ramp steps	3
5. Spindle	
<b>Speed Setting</b>	
Minimal	30000
Maximal	63000
<b>Start-up Delay</b>	
Delay	10
6. Calibration	
<b>Motor calibration</b>	
Y motor	0.941

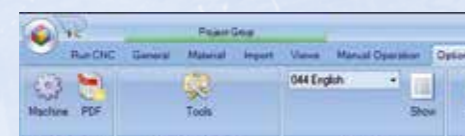

## API 3000 Bungard Application Module



The special application module API 3000 of Bungard extends the Bungard CCD circuit board plotter on the system customized software RoutePro 3000 and so fulfills many additional customer requirements. Measuring instruments or tools may coupled to the CCD, and all the data are processed via RoutePro 3000.

The actual interaction with the CCD takes place via a programming environment. Thanks to API 3000 the CCD can be remote controlled and connected to your own applications.

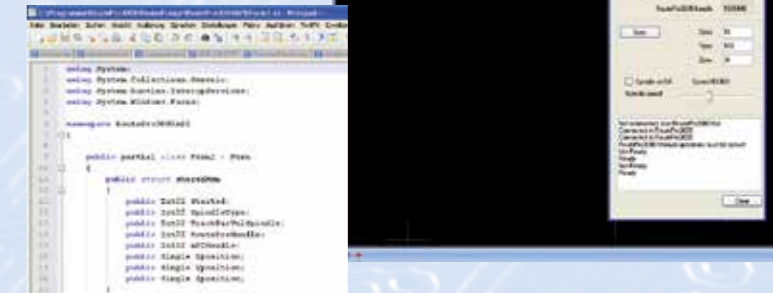

## QR-Code 3000 Bungard QR-Code-Documentation

A QR-code documentation provides fast and without much effort all necessary information about projects and workflows of a manufacturing process. The module QR-Code 3000 generated a very individual QR-code for every project of Bungard CCD at one touch by using the software RoutePro 3000. A unique code can be printed directly with a label printer and glued at the desired position of the board or workpiece. Behind the square matrix out of black and white dots, representing binary encoded data, information is optionally hidden for internal quality assurance and external customers. They document the manufacturing process of printed circuit boards, the workpieces and the deposited project name, the type of machine or operator.



The QR-code can be read with a standard 2D scanner or a smartphone. So the QR-code Label enables to call up the appropriate files in reissue of old projects. With an additional documentation license, the QR-module QR-Code 3000 offers other advantages for changes and extensions in future within a project.



## Modules for RoutePro 3000



Plus 3000



LaserPro 3000



DispPro 3000



Document 3000



Calibrate 3000



Inspect 3000



API 3000



QR-Code 3000

## PROCESS CONTROL AND AUTOMATIC OPTICAL INSPECTION

# QUALITYSCAN 3000

### What is QualityScan 3000?

QualityScan 3000 is a fully integrated, stand-alone process control, measurement and inspection workstation for use in many applications in multiple industries.

QualityScan 3000 uses a PC Windows based software package integrated with a high-resolution, calibrated, A3 size flatbed scanner. This combination allows for inspection of parts at virtually any stage of production. Parts can be inspected versus Gerber data, CAD data or Golden parts.

### Benefits:

- Catch problems BEFORE production floor – “Virtual problem”
- Catch problems DURING production – “Sampling for SPC”
- Eliminate REWORK
- Environmentally friendly
- Maximize existing capital investment
- Reduce operator, engineer & management stress

### Why QualityScan 3000?

- QualityScan 3000 systems are the standard in the industry for PCB/stencil/emulsion screen/film inspection – it’s the leading system in the world!
- Inspection is needed - It is not acceptable to ship or use defective parts!
- QualityScan 3000 is the lowest cost complete inspection system in the industry
- 100% inspection of part using CAD data or a Golden Part
- Inspect a wide variety of features on a single system... multi purpose
- Inspection of parts in any material including FR4, Polyamide, Rodgers, Thermount.
- Or plastic, paper, diazo, glass, chrome, electroform, stainless, silicon, etc
- Systems are very easy to use and based on a standard PC platform
- Optionally, create or modify CAD data to match existing parts when data is lost

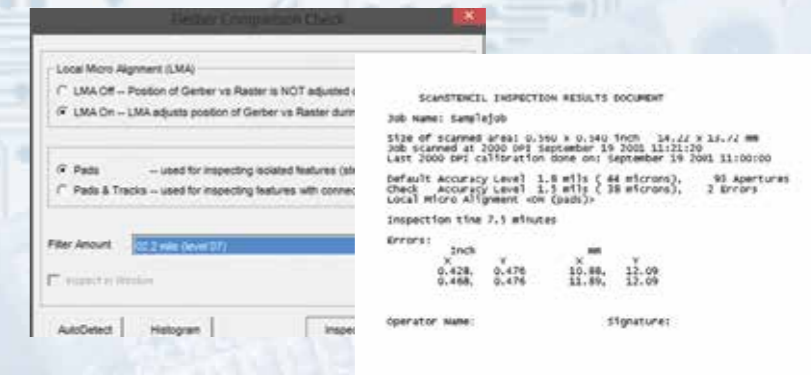
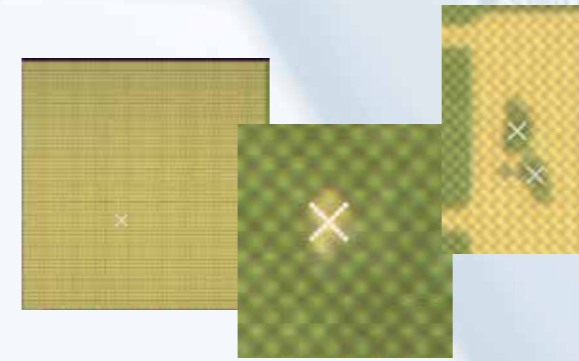

### Working Option - Components Program

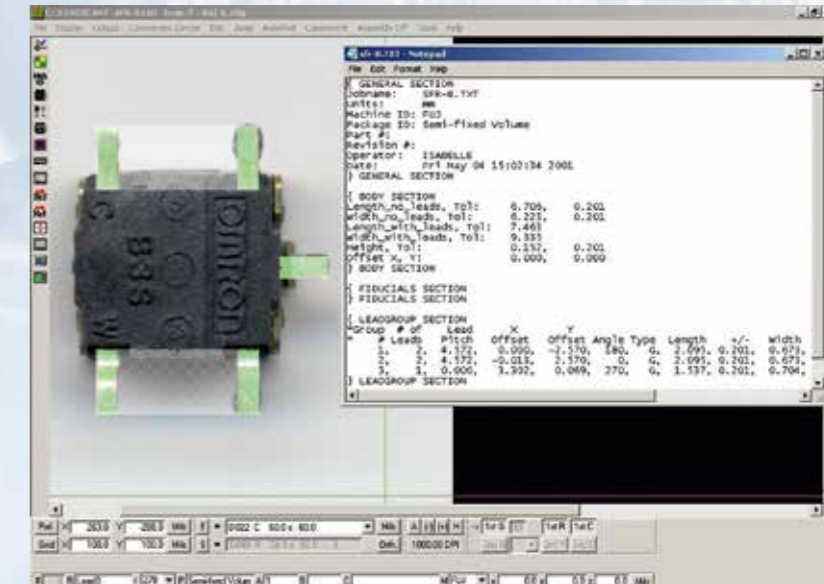
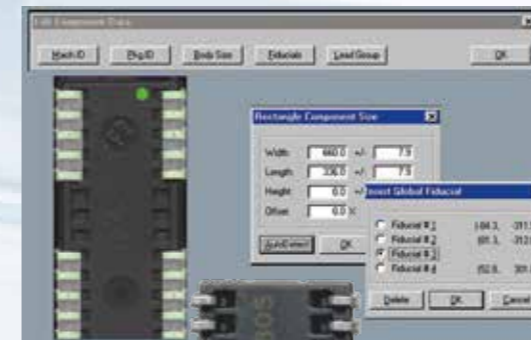

### Dual Monitor Option



## QUALITYSCAN 3000

Power consumption:	45 W
	2.8 W (Low modus)
	0.5 W (Standby)
Dimensions (LxWxH):	656 x 458 x 158 mm
Scan resolution:	2400 dpi x 4800 dpi
Absorbance:	3.8 Dmax
Weight:	approx. 14.5 kg



**DATA CONTROL  
CONVERSION  
ISOLATION MILLING**



**ISOCAM**

IsoCam 5.0 (Pro) and IsoCAM3000 are two software solutions for the machining and production of CAD-designed PCBs.

IsoCam 5.0 offers basic functions such as the import of Gerber, HP/GL and drilling data, various machining options and an integrated insulation milling program. As well as the creation of free areas (Rubouts). Upgrading to Isocam 5 PRO is possible. Then with more import and export functions (see table).

Feel free to test in advance!  
Demo versions in the download of our website:  
[www.bungard.de/en/service/downloads#demo](http://www.bungard.de/en/service/downloads#demo)



A more recent development is IsoCAM3000, a more advanced software solution. It features support for a wider range of file formats, impressive software resolution of 1 nanometer, and advanced algorithms for tool path calculation. IsoCAM3000 also allows users to automatically detect design violations and fix them with forced isolation. Other advanced features include cloning, rotating and panelizing objects, as well as integrating QR codes and other additional objects.

For developers who use a lot of ground layers in their design, IsoCAM3000 could be the ideal choice. However, if the advanced features of IsoCAM3000 are not of interest, IsoCam 5.0 offers a more cost-effective yet efficient alternative.

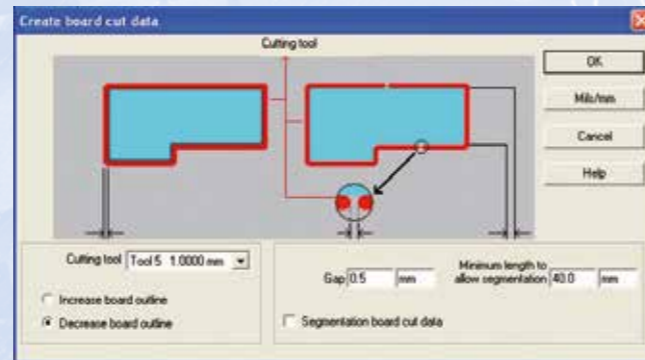

Result of an isolation milling using ISOCAM software

ISOCAM®	5.0	5.0 PRO	3000*
Gerber read / output (standard/extended)	YES	YES	YES
HPGL read / output	YES	YES	YES
Output Excellon for milling data	NO	YES	YES
DXF read / output	NO	YES	YES
Read / output bitmap	NO	YES	YES
Read in / output drill	YES	YES	YES
G-code output	YES	YES	YES
Optimize arcs	NO	YES	YES
Scaling	NO	YES	YES
Save job file	YES	YES	YES
Generate milling data	YES	YES	YES
Number of tools per insulation calculation	2	2	8
Number of tools per residual copper removal	2	2	8
Generate milling data for selected objects	NO	YES	YES
Units: Mils / mm / Inch / HPGL	YES	YES	YES
Design rule check	YES	YES	YES
Display milling direction	NO	YES	YES
Change milling direction	NO	YES	YES
Change start point of milling chain	NO	YES	YES
Mark whole milling chain	NO	YES	YES
Create solder stop mask	NO	YES	YES
Autosynchronize layers	YES	YES	YES
Add alignment holes	YES	YES	YES
Compensate board breakouts	YES	YES	YES
Mirror function	YES	YES	YES
Good zoom function	YES	YES	YES
Add objects	YES	YES	YES
Software Resolution	0.1um	0.1um	0.001um
Removes spikes (IPD)	NO	NO	YES
Forced isolation paths for problematic constrictions according to design review	NO	NO	YES
Windows coverage	XP to Win10	XP to Win10	XP to Win11
License protection with dongle	YES	YES	YES
Calculations with multiple threads	NO	NO	YES
Calculation speed of toolpaths / Milling data	Slow	Slow	Very Fast
Automass	NO	NO	YES

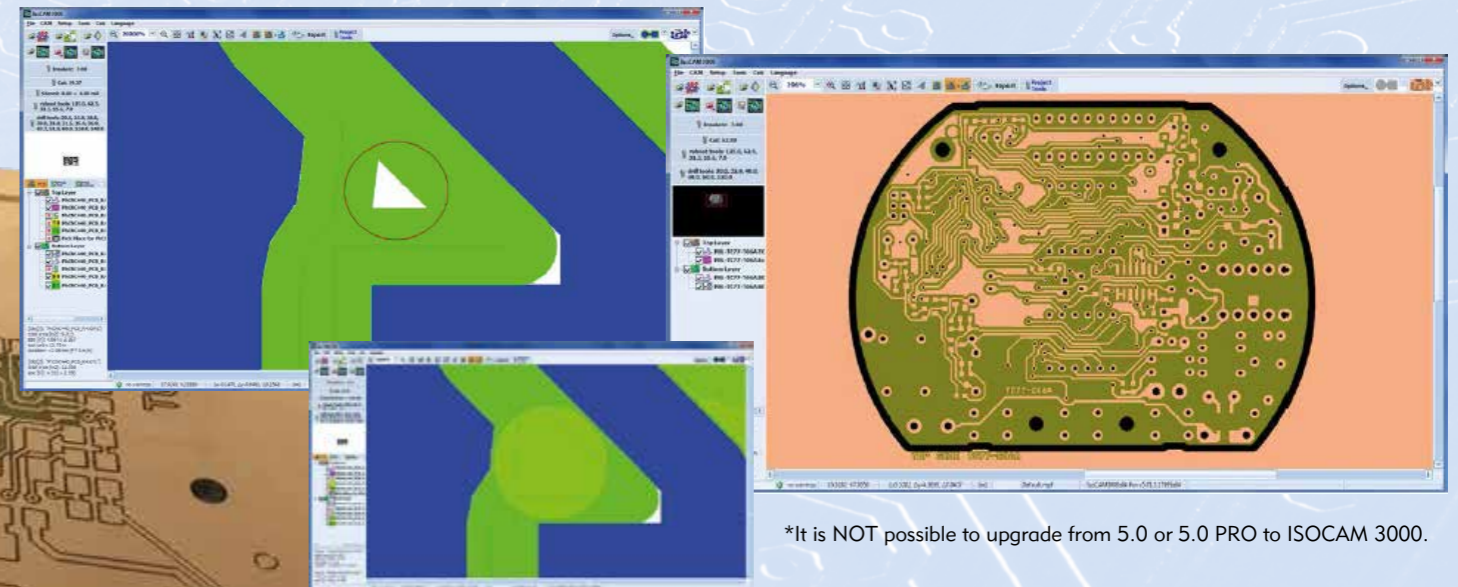

\*It is NOT possible to upgrade from 5.0 or 5.0 PRO to ISOCAM 3000.

## COMPACTA 30

### THROUGH-HOLE-PLATING LINE

This machine from the COMPACTA-series was consequently designed to meet the demands of professional direct metallization.

It can take boards up to 210 x 300 mm<sup>2</sup> and has 5 treatment tanks (cleaning - pre-dip - catalyst - intensifier - reserve tank) and one galvanic plating tank.

Two treatment tanks are thermostatically controlled and equipped with a teflon heater.

Bath movement on all tanks is performed with DC-gear motor. The stroke speed is stepless variable.

The galvanic plating tank comes with an integrated air injection and a stepless regulated rectifier. A Volt- and an Amperemeter show the current electric values.

Special emphasis was put on a unique rinsing technique. A double cascade rinse and a spray rinse, the latter activated via foot switch and a magnetic valve, are integral parts of the COMPACTA 30.

We also offer the COMPACTA as a complete system including chemicals, anodes, anode holders and board holders.

### COMPACTA 30

Tank dimensions	treatment tanks	galvanic copper tank
Length:	400 mm	400 mm
Width:	100 mm	275 mm
Depth:	300 mm	300 mm
Capacity:	10 l	30 l

<b>Total size (LxWxH):</b>	880 x 1000 x 1350 mm	
<b>Working level:</b>	950 mm	
<b>Weight:</b>	approx. 80 kg	
<b>Heaters:</b>	2 x 400 W	
<b>Rectifier:</b>	1 x 6 V, 40 A	
<b>Bath movement:</b>	DC-gear motor	
<b>Power supply:</b>	230 V, 50 Hz, 6.3 A	



Picture of COMPACTA 30

## COMPACTA 40 2CU

### THROUGH-HOLE-PLATING LINE

Based on the same principle of construction as our Compacta 30 series, the Compacta 40 2CU is optimized for higher productivity. You can manufacture boards with a maximum size of 300 x 400 mm<sup>2</sup>. This enlargement plus an integral, second plating bath leads to almost 4 times higher daily throughput with only little more space requirements.

Based on the COMPACTA-series we also produce machines for other chemical systems.

### COMPACTA 40 2Cu

Tank dimensions	treatment tanks	galvanic copper tank
Length:	500 mm	500 mm
Width:	100 mm	300 mm
Depth:	450 mm	450 mm
Capacity:	20 l	60 l

<b>Total size (LxWxH):</b>	1200 x 1180 x 1390 mm	
<b>Working level:</b>	950 mm	
<b>Weight:</b>	approx. 130 kg	
<b>Heaters:</b>	2 x 800 W	
<b>Rectifier:</b>	2 x 6 V, 80 A	
<b>Bath agitation:</b>	DC gear motor	
<b>Power supply:</b>	230 V, 50 Hz, 2,5 kW	



Picture of COMPACTA 40 2CU

### Alternatives for improved surface qualities:

Bungard is also experienced in galvanic nickel-gold-systems for long lasting, bondable surface quality. Moreover tin-, blackening- or sealbond-systems are available. Contact us for your individual, customized solution.

## MULTI-COATER

### THROUGH-HOLE-PLATING OR COATING

Regardless of whether it is through-plating, applying electroless nickel gold or extremely thin SOLGEL/lacquers, the Multicoater can do both.

A CNC axis system, also for already installed systems of our HITEC PLATE series.

#### Features

- Tanks customized to your needs
- automated process control by touch screen menu
- program storage on board
- user selection menu
- process parameters adjustable

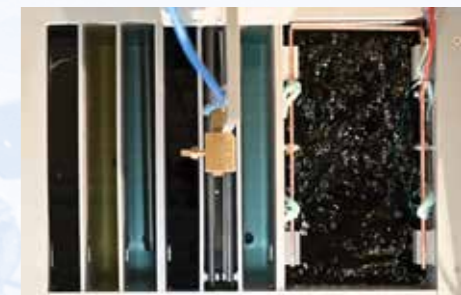

### MULTI-COATER

<b>Dimensions (LxWxH):</b>	830 x 900 x 2000 mm
<b>Power supply:</b>	210 x 300 mm
<b>Weight:</b>	approx. 200 kg
<b>Tanks:</b>	10/20/30 Liter
<b>Board sizes:</b>	230 V~, 50/60 Hz



Siehe auch Katalogseite 75



## HITEC PLATE 3040

### UNIVERSALLY ELECTROPLATING MACHINE

The HitecPlate 3040 is a universal electroplating system for the deposition of metals and is used for the production of plated-through printed circuit boards in vertical technology for prototype and small series production.

The HitecPlate 3040 is designed for direct metallization and has baths for process steps of cleaning, rinsing, pre-dipping, activating, rinsing, intensifying, rinsing, copper plating.

#### Features

- Benefits of machine
- Modular construction
- Compact design
- Easy operation, easy handling
- Clean work flow
- Uniform deposition of copper on the surface and the drill hole
- Automatic rinse water exchange possible

#### Construction of machine (basic module)

- Machine frame completely made from PVC
- 5 treatment basin
- Electroplating tanks
- Separate rinsing section for every process step
- Automatic rinse water exchange possible
- Anode frame
- Drain valve and cover for each basin
- Air injection for copper bath
- Agitation on all tanks, infinitely adjustable
- 2 Titanium heater
- Main switch
- Electronic rectifier, current or voltage constant mode



### HITECPLATE 3040

Function:	Plating-through-hole, copper galvanic
Max. Board size :	300 x 400 mm (350 x 450 mm)
Power supply:	230 V AC, 50 Hz - 60 Hz
Power consumption:	2000 W
Volumen Treatment tanks:	20 l
Volumen Galvanic tank:	60 l
Weight:	200 kg
Dimensions (LxWxH):	1520 x 1250 x 867 mm
Working Height:	900 mm

#### Optional extensions processes:

- Because of the modular structure the following additional processes can be integrated into the equipment:
- Tinning (subtractive technology)
- Desmear, Blackening, tin stripping
- Immersion Tin
- Organic protective layer (OSP)
- Electroless nickel / gold or
- Immersion Silver
- Galvanic nickel / gold
- Stripper negative resist

## PROTEC 2030 + 3040

### IMMERSION TIN FOR PERFECT LEAD-FREE SOLDERING

The PROTEC SN is a professional equipment for the production of final surfaces of printed circuit boards. The machine includes all necessary tanks and electrical equipment in a very compact design.



PROTEC SN with the ORMECON®-process guarantees:

- Planar surface for SMD technology
- Pure tin deposit, even with high copper load of the bath
- Significant reduction of diffusion velocity
- Multiple soldering possible, even with intermediate storage
- Improved temperature resistance

The design of the PROTEC SN enables to extend or reduce the equipment depending on the requirements e.g.:

- Electroless Nickel/ electroless Gold
- OSP organic solderability preservative

	PROTEC 2030	PROTEC 3040
Working area:	200 x 300 mm	300 x 400 mm
Teflon heating elements:	2 pieces per 400 W	2 pieces per 800 W
Dimensions (LxWxH):	approx. 790 x 710 x 1160 mm	
Power supply:	230V, AC	



## RLM 419 P

### DRY FILM LAMINATOR

The RLM is a dry film laminator especially made for small companies, schools, research and development departments. All commercial laminates for PCB manufacture and mould-etching technique can be processed. Due to adjustable pressure control and adjustable laminating speed, solder mask application is also possible without problems.

#### Features:

- Easy and fast mounting of resist rollers of all common coil diameters
- Detachable inlet table for easy access to lower resist roll

- Infinitely adjustable laminating speed
- Electrically heated lamination rollers with uniform temperature distribution
- Separate transport rollers for non-creasing laminate transport
- Digital setting and read out of lamination temperature
- Manually adjustable lamination pressure
- For all common dry film resists with 3 and 5 inch core diameter
- Suitable for solder mask application



### RLM 419 P

Lamination width max.:	400 mm
Transport width max.:	440 mm
Lamination speed:	0.2-1.2 m/min adjustable
Resist tension:	adjustable
Lamination pressure:	adjustable
Temperature range:	20 - 120° C digital setting
Power supply:	230 V 50 Hz / 2 kW
Weight:	38 kg
Dimensions (LxWxH):	690 x 630 x 570 mm

## RBM 300

### BRUSHING MACHINE

A professional brushing machine designed for use in small series production and laboratories. High quality wet-processing brushing machines for PCB production at low price are possible! The proof is the Bungard RBM 300. The smaller sister of our RBM 402 is reduced wherever possible but not at quality, endurance and high precision details.

#### Features:

- The RBM 300 has an oscillating brush with quick change device
- Oscillation frequency and transport speed are stepless variable
- Parallel height adjustment. In contrary to the single sided height adjustment, you will achieve a long term even brushing result only with double sided parallel height adjustment.
- Machine is equipped with a finishing brush used before laminating. Various brushes available.

- Working width 300 mm
- Despite its small size, the RBM 300 has a full scale squeeze-off and hot air drying compartment
- As bench top model the RBM 300 has no integrated water treatment. A closed loop rinsing tank is available as an option
- Single side action
- Aluminium, PVC, Stainless Steel construction
- Transparent top lid with security switch
- Mechanical drying by squeezing rollers

#### RBM 300

Usable width:	300 mm
Board thickness:	0,3 - 3 mm
Brushing speed:	1360 rpm
Conveyor speed:	0.2 - 2 m/min
Oszillation stroke:	10 mm
Oszillation frequency:	approx. 10 - 110 1/min
Stroke speed:	approx. 0,2 - 2 m/min
Rinsing system water consumption:	6,8 l/min.
Power supply:	230 V~, 50 Hz
Dimensions (LxWxH):	760 x 590 x 415 mm
Weight:	80 kg



## RBM 300 KF

- Closed loop water management with filtration.
- Stand alone with rack and integrated water tank.



Picture of RBM 300 KF

## RBM 402 KF

### BRUSHING MACHINES

The RBM 402 KF series is the highest developed brushing machine in our range and can be used for practically all cleaning operation during PCB manufacturing. It is ideally suited for professional prototyping or smallbatch production in modern PCB laboratories. The RBM 402 consists of a double sided wet processing brush compartment, a rinsing and a following squeeze-off zone and hot air drying compartment. The solid construction guarantees proper function and a long life time with a minimum of maintenance.

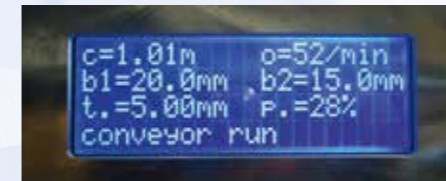

#### Features:

- simple brush exchange via quick change device
- precise parallel brush adjustment with hand wheel
- Oscillation and transport are stepless adjustable
- Digital read out for board thickness and power consumption of the brush motor
- Upper and lower brushing rollers are adjustable in pressure and have a digital read-out for the settings.
- The wet-processing system comes together with a powerful squeeze + hot-air dryer.
- The „KF“ is indicating an integral closed loop rinsing system. That is urgently recommended in order to comply with German and European waste water regulations.

#### RBM 402 KF

Working width:	400 mm
Conveyor speed:	0.2 - 2 m/min
Oscillation stroke:	10 mm
Oscillation frequency:	10 - 110 lifts/min
Brushing roller length:	410 mm
Brushing roller outside diameter:	89 - 91 mm
Brushing speed:	1360 rpm
Board thickness (rigid boards only):	0.3 - 5 mm
Board sizes:	(min.) 80 x 175 mm
Rinsing system water inlet:	19 mm
Rinsing system water outlet:	40 mm
Rinsing system water consumption:	26 l/min.
Power supply:	230 V, 50 Hz, max. 16A
Dimensions (LxWxH):	1110 x 750 x 1160 mm
Weight:	220 kg (RBM 402 KF) 170 kg (RBM 402 BLC)
Brushing stroke on upper roller:	max. 20 mm
Brushing stroke on lower roller:	max. 15 mm
Feed per turn of hand wheel:	0.266 mm
Brushing roller inner diameter:	35 mm
Rinsing system pressure: max.	1.5 bar

#### Also available version:

RBM 402 BLC:  
bench-top low cost version

RBM 402 KF:  
closed-loop version with tank and candle filters



Picture of RBM 402 KF

## AIR 2000

### CONVEYORIZED PCB DRYER

Air 2000 is a conveyORIZED PCB Dryer. Adjustable transport speed ensures perfect drying of holes and surfaces after all wet process sequences.



#### Features:

- Continuous drying
- Variable transport speed
- Suitable for different board thicknesses
- Low surface temperature
- Short heating-up time
- High throughput
- Bench top machine
- High quality construction

#### AIR 2000

Working width:	300 mm
Board thickness:	0.2 - 4 mm
Minimum board length:	80 mm
Transport speed:	0.2 - 1.2 m/min
Heat up time:	5 sec.
Dimensions (LxWxH):	362 x 352 x 520 mm
Power supply:	230 V 50Hz

## ULX 110

### DRYING AND CURING OVENS

The universal oven is our classic appliance for temperature control in science, research and material tests in industry.

This machine is a perfect masterpiece in terms of technology and is made of high-quality, hygienic, easy-to-clean stainless steel. In regard of ventilation and control technology, overtemperature protection and precisely tuned heating technology all possible aims are perfectly fulfilled.

#### Features:

- Forced air circulation by quiet air turbine, adjustable in 10 % steps
- Adaptive multifunctional digital PID-microprocessor controller with high-definition TFT-colour display
- Digital backwards counter with target time setting, adjustable from 1 minute to 99 days

#### ULX 110

Max. loading of chamber:	175 kg
Dimensions (LxWxH):	864 x 745 x 864 mm
Inner dimensions (LxWxH):	400 x 560 x 480 mm
Liter:	108 l
Net weight approx.:	approx. 78 kg
Temperature Range:	up to + 300°C
Power supply:	230 V~, 50/60 Hz / approx. 2.800 W



## ULX 110



## RDC 15

### DIP COATER

The RDC 15 is a machine designed for laboratory dip coating of modern liquid photoresist. Today a more and more popular application is the so called: „sol-gel-application“. This machine was developed to meet the demand of a greater variety of speeds, iterations, dipping and drip off times and heavier workpieces.

#### Features:

- Lift bar for several workpiece fittings. The dipping height and the sizes of the aluminium profiles can be easily adapted to even dip-coat bulky items.
- The insertion and the drawing or coating speed is separately adjustable from 30 mm/min until 10.010 mm/min.
- The dipping time as well as the drip-off-time (pause time up and down) is separately adjustable from 0 s up to 99 h : 59 min : 59s. This enables the machine not only to coat but to precisely develop. This is of great importance with certain photo coatings of the miniature etching technology.
- Up to 8 iterations are possible.
- The working range of the lift bar can be adjusted via the control panel. The maximum size of the workpiece is therefore only limited by the maximum lift range of the machine and the size of your cuvette.



#### RDC15

Stroke length:	0 - 600 mm
Maximum load:	1.5 kg
Weight:	12 kg
Dimensions (LxWxH):	330 x 465 x 965 mm
Insertion speed:	Programmable from 30-10.010 mm/min
Drawing speed:	Programmable from 30-10.010 mm/min
Dipping Time:	0 s - 99 h : 59 min : 59 s
Drip Off Time:	0 s - 99 h : 59 min : 59 s
Iterations:	Up to 9 times
Power supply:	100 - 240V, 50-60 Hz, 120W

## RDC 21-K

The RDC 21-K is a machine designed for laboratory dip coating. They can be used to apply liquid photoresists to e.g. miniature etching parts or other substrates, to apply liquid solder mask or any other kind of protective or technical coating. Today more and more popular application is the so called: „sol-gel-application“. This machine was developed to meet the demand of a greater variety of speeds, iterations, dipping and dripping times and heavier work-pieces.



#### Advantages compared to RDC15:

- Foil keyboard for easy data entry
- Virtual end switch avoids unnecessary drives
- Separate speed settings for dipping, coating and positioning drives possible
- Stronger Stepper motor enables a 4-times higher load (5 kg instead of 1,5 kg).
- Minimum speed down to 1 mm/min. As an option 0.5 mm minimum speed also possible
- Parameters are stored for the next job after switching off machine
- Controller is tiltable and removable

#### RDC 21-K

Stroke length:	650 mm
Maximum load:	5 kg
Weight:	12 kg
Dimensions (LxWxH):	330 x 465 x 965 mm (Height 1030 mm with controller)
Insertion speed:	Programmable from 1-3000 mm/min or 0.5 - 1500 mm/min
Drawing speed:	Programmable from 1-9999 mm/min or 0.5 - 4999,5 mm/min
Dipping Time:	0 s - 99 h : 59 min : 59 s
Drip Off Time:	0 s - 99 h : 59 min : 59 s
Iterations:	Up to 1000 times
Power supply:	100 - 240V, 50-60 Hz, 120 W

## RDC 30 MULTIDIP

The RDC 30 dip coater is a logical further development of the RDC 21-K. In addition to the precise immersion processes, it allows the use of up to 6 different liquids in an almost infinite number of possible sequences.

The devices are used for the photoresist coating of form-etched parts and substrates, for the application of liquid solder resist masks and for coating with protective lacquers in general. A new and interesting field of application are so-called SOL-GEL applications.

- Rotary table with 6 cups for multi-coating!
- Each dive individually programmable (diving, drawing speed, dipping and dropping time)
- integrated magnetic stirrer with programmatic function and speed (1 - 999 1/min)
- Diving and drawing speed between 1 - 3000 mm/min
- Distance speed is separately adjustable from 1 - 9999 mm/min
- Save this job and job iterations possible

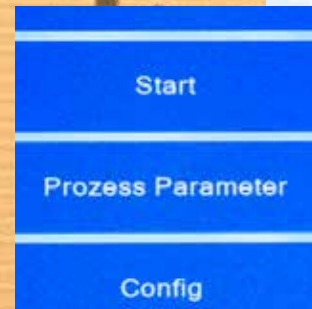
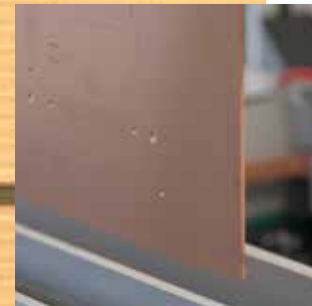

### RDC 30 MULTIDIP

Stroke length:	0 - approx. 650 mm
Maximum load:	5 kg
Weight:	15 kg
Dimensions (LxWxH):	380 x 470 x 1030 mm (Height 965 mm without controller)
Insertion-/Drawing speed:	1-3000 mm/min
(optional)	0,5-1500 mm/min
Distance speed:	1-9999 mm/min
(optional)	0,5-4999,5 mm/min
Dipping Time:	0 s bis 99 h:59 min.:59 s
Drip Off Time:	0 s bis 99 h:59 min.:59 s
Iterations:	Up to 1000 times
Power supply:	100 - 240V, 50-60 Hz, 120 Watt

## MULTI-COATER

### COATING OR THROUGH-HOLE-PLATING LINE

The new solution for your laboratory.

Do you want to plate through hole?

Or do you need to apply Nickel Gold (electroless)?

Or do you want to apply other coatings like SOL-GEL?

This multicoater is your answer!

Gantry system also for existing HITEC PLATE machines from Bungard

#### Features

- Tanks customized to your needs
- automated process control by touch screen menu
- program storage on board
- user selection menu
- process parameters adjustable

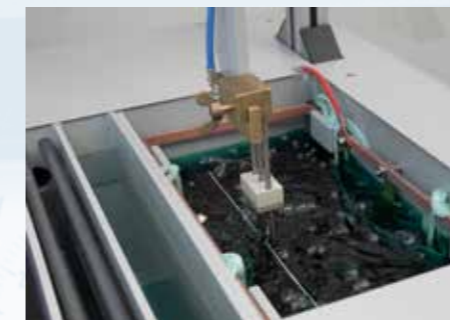
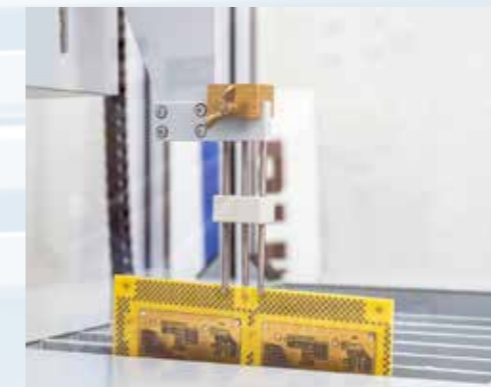

### MULTI-COATER

Dimensions (LxWxH):	830 x 900 x 2000 mm
Power supply:	210 x 300 mm
Weight:	approx. 200 kg
Tanks:	10/20/30 Liter
Board sizes:	230 V~, 50/60 Hz

The handling system of MULTICOATER is very flexible. You can load and save programs.

You can TEACH positions

We will supply standard programs.

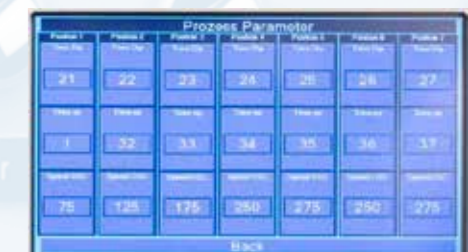

# BUNGARD PICK&PLACE SMT3000

Manipulator for the production of prototypes and small series. The patent-registered Pick & Place head enables the comfortable handling of SMD-components. The modular-built system can be configured for every use. It realizes the complete process - starting by dispensing of solder paste or glue up to assembling different components.

### Features:

- Ergonomic
- Integrated dispenser unit
- Camera fixture
- X/Y-locking device
- Head lightening
- PCB holders
- Desktop workplace
- High end quality

### Vision system

By means of a camera attached directly to the assembly head, you can view the entire pick & place process – enlarged on a monitor.

### X/Y-locking device

The X/Y locking device ensures precision mounting. Individual movement axes can be locked. An automatic function independently locks the X and Y axes when the components are lowered or when placing a dispenser dot. This makes it particularly easy to place Melfs.

### Head lightening

The dual LED-light of the pick and place area can be integrated optional. The LEDs are placed on both sides of the nozzle and enable the constant and permanent lightening under the assembling head. The integration into the control mode of the Manipulator allows the menu routed activating - depending on application.



### PCB holders

All manipulators have a universal circuit board holder by standard for single- or double-sided PCBs. Elastic holding fingers are adjustable and hold the board in place. Large PCBs can be handled on demand. Customer-specific holders can be adapted or realised directly at our plant.

### SMT 3000

Assembling:	300-600 SMDs/hour
Dimensions (LxWxH):	600 x 600 x 345 mm
Max. outreach (LxWxH):	600 x 1100 x 345 mm
Max. PCB size (LxW):	440 x 245 mm
Max. assembling area (LxW):	350 x 245 mm
PCB thickness:	0,5 mm to ~ 4 mm
Height underneath PCB:	min. 39 mm, max. 50 mm
Components:	Chip 0201 bis QFP 0,65 mm pitch
Max. component height:	approx. 16 mm
Hub of assembling head:	max. 26 mm
Rotation angle:	0-360°
Weight:	approx. 23 kg
Power supply:	100- 230 V AC, automatical
Input:	max. 50 VA

(Only by dispensing unit):  
clean, oil-free compressed-air, max. 4 bar,  
1,5 l/min consumption while dispensing  
pressure connector for tube iØ 4mm, oØ 6mm



## COMPONENT FEEDER

The system enables the feeding of components in tapes as well as loose components.



### Carousel

The antistatic manual carousel with 45 shelves feeds loose components in a comfortable way.



### Tape strip feeder

This feeder type can handle a single strip of a component tape. Each part can be picked up directly from the tape, it isn't necessary to decante them into bulk containers first.

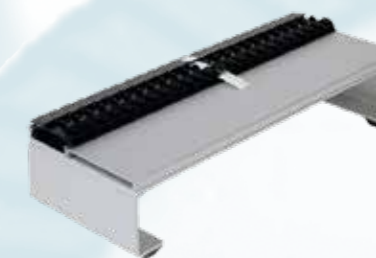

### Tapfeeder

Tape feeders supply you with large amounts of standard components. While removing the cover-tape, the tape is automatically feeded and the components, that should be placed next, are revealed.

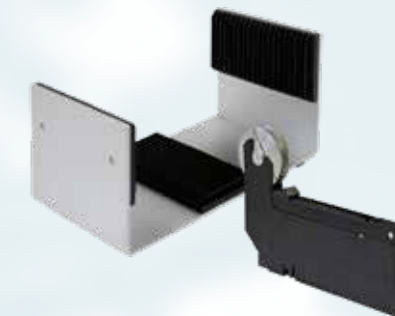

### Bulk container

The patented bulk containers provide resistors, capacitors and ICs out of small containers to the machine.



## HOTAIR 06

### REFLOW OVEN

The HA06 is a solder oven for SMD component with the use of lead free paste.

The oven is work-ing with full convection forced air during the preheat stage. When the reflow stage is entered the heating will be done by hot air and quartz lamps.

The lamps are needed to get a short ramp speed. Once the reflow set point is reached the lamp power will be reduced to a minimum. At this point 85% of the heating is caused by forced hot air. This unique feature makes the oven suitable for solder big SMD components and/or components with pads under their casing while using lead free paste.

With good maintenance and proper use the oven will serve your solder needs for a long time with high quality solder results.



### Some of the features include:

- Outstanding reflow soldering quality for SMD and hybrid
- Hot air quartz oven Cures SMD adhesive
- Two heating zones
- Microprocessor controlled
- Reflow process view

### HOTAIR 06

Power req.:	208/240 V1 phase 50/60 Hz
Rated power:	max. 3650 W
Dimensions (LxWxH):	550 x 490 x 335 mm
Max. Substrate surface:	300 x 370 mm
Number of heating zones:	2 zones microprocessor controlled
Preheat time:	0-999 sec.
Preheat Temp:	60 - 260°C
Reflow Time:	0-999 sec.
Reflow temp:	90 - 300°C
Heat up time to thermal stabilization:	approx. 8 min.
Net weight:	18 kg
Options:	connection inert gas N2 with flow meter

## SMT 3000 ECO BASIS

### MANUAL PICK&PLACE-MANIPULATOR

Manipulator for the production of prototypes and small series. The patented Pick & Place head enables easy handling of SMD components. The modular system can be configured for any application. The system realizes the entire process from applying the solder paste or glue to assembling the various components.

#### Features:

- Manipulator for assembling SMD components
- Smooth-running XY portal with placement head in the Z axis
- With flexible magnetic circuit board holder, hand rest
- Holding rail with 5 tape feeders and universal component support
- Stand with 36 containers and vacuum pump
- Housing and palm rest powder-coated in light grey 7035



#### Options:

##### Dosing device

The manipulator can be expanded to a dispenser by means of a compressor and a manual dosing device. In addition to solder paste and adhesive, other media can also be dispensed.

##### Component feeder

The components can be provided in the belt as well as in bulk on the system for processing.

##### Tape feeder

Tape feeders can stock standard components in large quantities at the workplace. When the cover tape is removed, the belt is automatically advanced and the components to be processed are exposed.

##### Laboratory belt dispenser

The belt sections required for production can be processed with the laboratory belt dispenser. The individual components can be removed directly from the belt and there is no need to transfer them to bulk containers.

##### Bulk container

The bulk goods container provides capacitors, resistors and ICs on the manipulator.

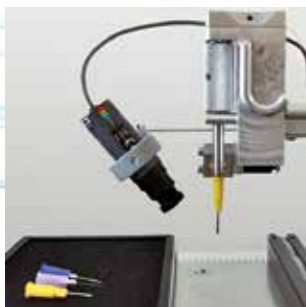
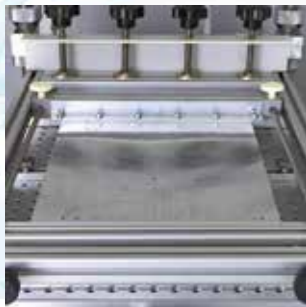

#### Camera + Monitor (SMT 3000 ECO Plus)

Using a camera that can be adapted directly to the placement head, the entire placement process, from picking up to placing the component, can be shown enlarged on a monitor.



### SMT 3000 ECO

Assembling:	ca. 200-500 SMDs/hour
Dimensions (LxWxH):	600 x 600 x 200 mm
Max. outreach (LxWxH):	600 x 840 x 200 mm
Max. PCB size (LxW):	340 x 170 mm
Min. PCB size (LxW):	8 x 8 mm
Max. assembling area (LxW):	270 x 170 mm
PCB thickness:	0,5 mm bis ~10 mm
Height underneath PCB:	max. 18 mm
Max. component height:	ca. 20 mm
Hub of assembling head:	max. 25 mm
Rotation angle:	0-360°
Weight:	ca. 15 kg
Power connection:	220- 240 V AC, 5VA

## PRINTSTAR 3000

The stencil printer PrintStar 3000 manual printing machine with high precision is mainly designed for requirements of single or double-sided circuit board solder cream or red glue printing. The working platform is processed by cellular positioning hole with high-quality aluminum and its pedestal is welded by thick steel plate with steadiness and durability. Its characteristics are as follows:

- Circuit board adopts positioning needle, fixed rod and fixed plate for positioning, which can ensure convenient positioning and accuracy of repeated operation.
- Make ready mode is made through stencil's movement and combined with fine adjustment and correction of X, Y axis in printing platform, which is convenient and quick.
- Stencil stent uses spiral bearing and height can be adjusted up and down, which is convenient to control PCB's thickness and volume of printing cream.
- Printing plates are fixed by four rotary knobs with platen and it is quick and strong.



### PRINTSTAR 3000

Size of workbench:	300 x 400 mm
Max printing size:	250 x 400 mm
Max screen frame dimension:	370 x 470 mm
Printing speed:	Manual control
Vertical and horizontal adjustment volume of workbench:	10 mm
Height of printing platform:	220 mm
Repeatability precision:	+/- 0.01
Location Mode:	Shape or benchmark hole
Dimension (LxWxH):	540 x 370 x 350 mm
Weight:	+/- 36 kg

## HOTAIR 3000

The HotAir 3000 is a stylish, practical reflow oven for manufacturing and reworking of SMT products.

The oven has a large display. The intuitive menu navigation is controlled by a membrane keyboard. The product uses highly efficient infrared heating elements and has several thermocouple temperature gauges.

Due to this and the precise evaluation in the microprocessor, the temperature curve of the reflow process is highly accurate and the temperature in the respective reflow sections very uniform.

With the HotAir 3000 all common alloys can be processed. The oven has an automatic error detection with alarm.

This product has a variety of applications such as reflow soldering, repairing, drying and so on. It is suitable for SMT small series, for research and development of electronic products, school, education and study. The operating system software is in english.

The stove is well insulated by a special aluminum silicate cotton, which reduces energy consumption, protects the circuit and allows optimal operation and keeps the temperature in the furnace constant.



### HOTAIR 3000

Power connection:	200 - 230 VAC. / 50-60 Hz
Max. Power Consumption:	2400 W
Max. PCB-Board Size:	350 x 300 mm
Time Settings:	00:00 - 99:59 sec.
Temperatur:	60 - 300 °C
Setting Options:	5 Phases adjustable in time and temperature: 1. Preheat, 2. Heat, 3. Soldering, 4. Holding and 5. Cool down
Working Modi:	Automatic Reflow-Soldering Permanent Heating or Drying function Option to store 4 different Reflow profiles
Interface:	Grafic display with Keyboard automatic Alarm function Display of Process progress
Heatup Time:	ca. 8 min
Dimensions (LxWxH):	504 x 500 x 314 mm
Weight:	+/- 28 kg



# RMP 210 / RMP 3545

## MULTILAYER PRESS

This high performance multilayer press was designed for PCB labs to enable quick prototyping of multilayer PCBs according to industry standards.

Number of layers is only limited by the maximum lift of the press plates (38 mm). Using separating metal sheets one can press a couple of boards over each other at the same time.

A compact and floor standing aluminium rack contains all parts of the unit including pressure supply, press plates and heaters.

The large loading door allows quick and easy access to the press chamber and is of course security switch protected.

A compressor, which is integral part of RMP 210 / RMP 3545 is stored in the back of the machine.

In the front, you will find additional storage room for tools or boards (lower door).

The unit is controlled by two digital and adjustable thermostates, one digital timer as well as a pressure valve with pressure meter.

Four strong air ventilators are activated automatically during cooling cycle.

### Steps of multilayer production with RMP 210 / RMP 3545:

- Boards are pinned and stack is inserted into press plates.
- Pressure is created.
- Heater is activated.
- Heating up procedure.
- Press procedure at preset temperature.
- Cooling down under pressure.
- PCB stack is taken out of the machine.

The entire sequence will take approx. 3 hours if you start at 20°C and take out the PCBs at a temperature of 30°C. If you take up protective measures, you can remove the boards at higher temperatures and insert a new stack. This way the press cycle reduces to approx. 45 min. Gross size of the PCBs is 250 x 350 mm (or 350 x 450 mm) which corresponds to a PCB net size of 210 x 300 mm (or 300 x 400 mm). To register the layers of your multilayer you can use the register hole function of our software IsoCam and the Bungard Favorit fixes the layers with rivets.

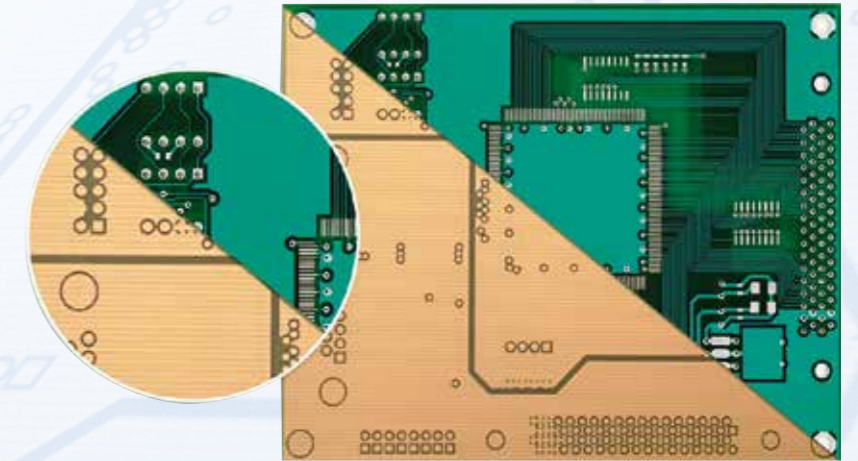

Picture of RMP 210



Picture of RMP 3545

### RMP 210 / RMP 3545

	RMP 210	RMP 3545
<b>Board size:</b>		
gross	250 x 350 mm	350 x 450 mm
net	210 x 300 mm	300 x 400 mm
<b>Pressure:</b>	> 12 t	> 24 t
<b>Temperature:</b>	up to 250°C free adjustable (max 300°C as an option)	
<b>Heating up:</b>	approx. 30 min.	
<b>Pressure time:</b>	approx. 60 min.	
<b>Cooling down:</b>	approx. 120 min.	
<b>Weight:</b>		
RMP 210	approx. 130 kg	
RMP 3545	approx. 260 kg	
<b>Dimensions (LxWxH):</b>		
RMP 210	650 x 650 x 1390 mm	
RMP 3545	830 x 870 x 1600 mm	
<b>Power supply:</b>		
RMP 210	230 V~, 50-60 Hz, 4000 W	
RMP 3545	400 V~, 50-60 Hz, 6000 W	

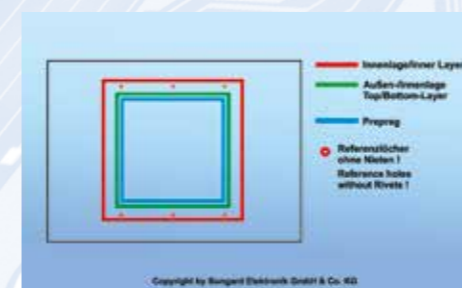
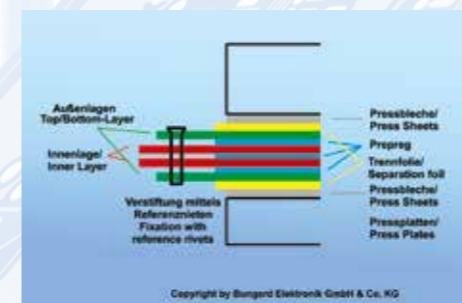
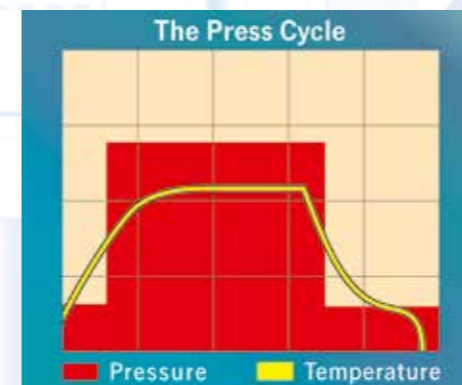

### Schematic of a 6-layer and a 4-layer PCB

6-layer PCB	4-layer PCB
Top layer 18 µm CU 0.2 mm total thickness	Top layer 18 µm CU 0.3 mm total thickness
Prepreg 1 x 0.1	Prepreg 1 x 0.2 mm
Inner layer 2 x 35 µm CU 0.3 mm total thickness	Inner layer 2 x 35 µm CU 0.5 mm total thickness
Prepreg 1 x 0.2	Prepreg 1 x 0.2 mm
Prepreg 1 x 0.1	Bottom layer 18 µm CU 0.3 mm total thickness
Inner layer 2 x 35 µm CU 0.3 mm total thickness	
Prepreg 1 x 0.1	
Bottom layer 18 µm CU 0.2 mm total thickness	

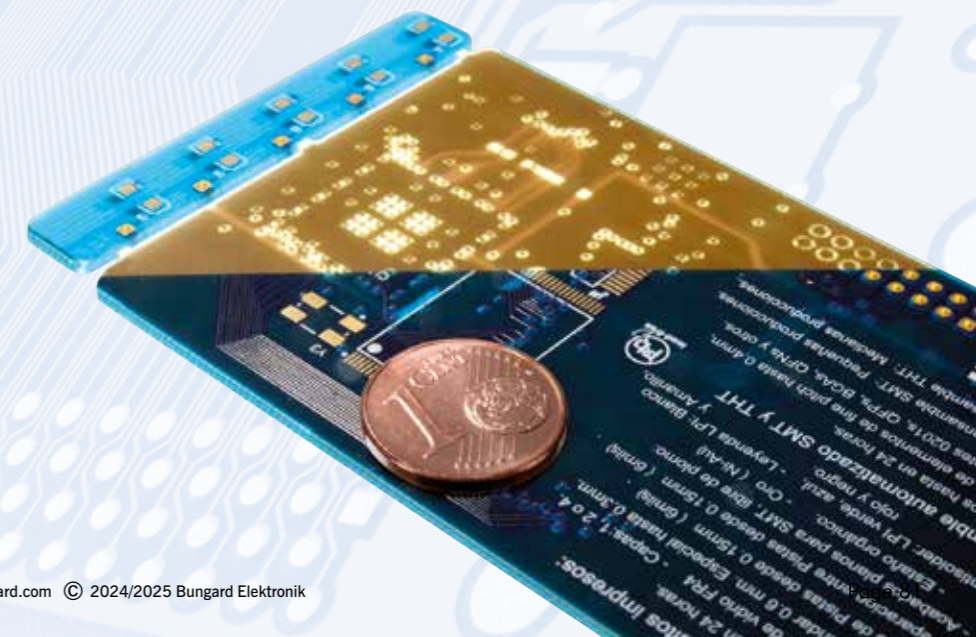

# BUNGARD



## WORLD-WIDE



In 1961, Heinz Hans Bungard (Picture) founded Bungard Elektronik GmbH & Co KG which is nowadays a global player with representatives in 62 countries of the world and 2 manufacturing plants in Germany



## GENERAL SALES CONDITIONS

Juli 20201. General

Our deliveries are exclusively subject to the conditions set forth herein which shall be deemed to be explicitly accepted by the purchaser. No conditions which may appear on the purchaser's order shall be binding on us, even without our express contradiction.

### 2. Quotations and orders

Our quotations are not binding on us. This applies also to information contained in price lists, leaflets etc.. Delivery dates stated in our quotations or given to the purchaser by any other means are approximate, and we endeavour to keep to them. Delays in delivery shall give no right to claims, unless we have explicitly confirmed such delivery dates and an adequate period of grace granted to us has expired. Orders shall only be binding on us when they are explicitly confirmed in writing, regardless of the form in which they have been placed with us. The data given in our catalogues are only product descriptions, and in no case they can be regarded as guaranteed characteristics. Furthermore the characteristics of our samples cannot be regarded as guaranteed characteristics.

### 3. Prices

Prices shall be valid only when confirmed by us in writing. They are exclusive of VAT at the current rate and incidentals such as postage and packing, freight, insurance etc..

### 4. Conditions of payment

4.1. Frequently buyers may be supplied on credit account. That must be negotiated before. Height of credit lines are depending on yearly overturn with BUNGARD during the last 12 months.

4.2. New customers, buying from Bungard since less than 1 year will not be supplied on credit.

4.3. For orders of less than 25 000 Euro, we insist in prepayment by SWIFT to our international bank account. Payments costs are born to buyer.

4.4. For orders of more than 25 000 Euro, buyer has to open an irrevocable LC, available and confirmed by any German bank, preferably Deutsche Bank. All LC costs and banking fees inside and outside Germany are to opener's account.

### 5. Set-off, right to retention

Only uncontested or legally binding counter-claims may be offset against our invoices. Any right to a retention to be exercised by the purchaser in connection with our claims is explicitly excluded.

### 6. Delivery

Delivery of our goods is explicitly made on behalf of and at the risk of the purchaser. The risk shall pass on to the purchaser when the ordered goods leave our premises. The same applies if goods are collected in our premises after notification of their readiness. We decide at our discretion on the most economical delivery method without assuming any liability for the chosen means of delivery.

### 7. Reservation of proprietary rights

7.1 All goods supplied shall remain our property until all of our claims resulting from the contract have been paid in full. The purchaser is entitled to dispose of the purchased goods in the ordinary course of business transactions. Reservation of proprietary rights also applies to products resulting from processing, mixing up or combining our goods with goods of third parties, in which case we are considered as manufacturers. In the case where our goods are processed, mixed up or combined with goods of third parties, and the proprietary rights of such third parties remain in force, we are entitled to co-ownership according to the proportion of the amount invoiced for such processed goods. Such right to co-ownership shall be safeguarded by the purchaser.

7.2 The purchaser shall transfer to us, as a security, his claims against third parties resulting from the resale of our goods in full or in the proportion of our co-ownership (see subparagraph 7.1). He is entitled to collect the amount of such claims on our behalf until revoked or until cessation of his payments made to us. The purchaser is not entitled to assign these claims to third parties.

7.3 The purchaser is not entitled to mortgage or transfer the goods which are subject to reservation by way of security.

7.4 The purchaser shall advise us immediately at any seizure of our goods or of any infringement of our rights by third parties.

7.5 In case of a default in payment or a deterioration in the financial situation, we are entitled to request immediate handing over of the goods which are subject to reservation. Any time limited claims shall immediately become due.

7.6 If the value of the securities exceeds our claims by more than 20%, securities to a corresponding amount will be released by us on request at our discretion.

### 8. Warranty and transport damages

We supply all our machines under a 12 month in-house warranty on parts and workmanship. This means that in this period of time, we repair or, at our choice, exchange, defective parts free of charge and at our facilities. This warranty does not cover transport fees.

Any user intervention to the machine / appliance will void the warranty, if not explicitly requested by us. Normal wear (i.e. on drive belts or spindle bearings) or damage from user intervention (i. e. pulling pc boards from units under tension) are not covered by this warranty.

Our local representative / dealer is in charge of technical assistance in any case of damage. Details of repair / exchange measures and coverage of transport fees are to be handled between our representative and us.

The purchaser shall check possible damages of our supplied goods on transit or transport immediately upon receipt and inform us in writing of visible defects at the latest 8 days after receipt. Complaints made at a later date will not be accepted by us. The purchaser shall give us the opportunity to convince ourselves of the rightfulness of the claim. If a claim is justified, we may repair the damage, supply replacements or refund the purchase price at our discretion. Further claims of the purchaser, especially claims for damages, are explicitly excluded, unless certain features of the goods had been assured by us. Claims for faulty delivery will in any event come under the statute of limitation six months after delivery.

### 9. Withdrawal

When delivery in accordance with the contract is not possible for reasons beyond our control, we are entitled to withdraw from the contract. Such withdrawal shall not entitle the purchaser to assert any right against us.

### 10. Place of performance and jurisdiction, applicable law

The exclusive place of performance and jurisdiction for both parties shall be 51570 Windeck Germany. Any contract shall be governed by the law of the Federal Republic of Germany.

### 11. Severability clause:

If any clause herein is or will become invalid, such clause shall not affect the validity of the remaining clauses. The invalid paragraph shall be replaced by a valid clause which shall meet as closely as possible the legal and commercial purpose of the original one.

Bungard Elektronik GmbH & Co. KG  
51570 Windeck



Address:

**BUNGARD**  
BEZ

Bungard Elektronik GmbH & Co. KG  
Rilkestrasse 1  
D-51570 Windeck

Contact:

Phone: +49 2292 / 9 28 28-0

Fax: +49 2292 / 9 28 28-29

e-mail: [info@bungard.de](mailto:info@bungard.de)

[sales@bungard.de](mailto:sales@bungard.de)

[support@bungard.de](mailto:support@bungard.de)

Web: [www.bungard.com](http://www.bungard.com)



