



A registered trademark of SNA Europe Group

MOST FLEXIBLE SOLUTION



▶ A RANGE OF TOOLS AS INDIVIDUAL AS YOUR

Comprehensive range with more than 15,000 products

More than 500 ergonomic hand tools

Numerous proven standard ranges

Development of customised workshop trolleys and ranges

For the first time, Bahco, the innovation driver of the tool sector, is offering a free software solution which allows customers to optimally design and configure their workshop trolley, foam inserts and tools to their individual requirements.

The software allows you to configure everything from the individual composition of your tool selection or the customisation, colour scheme and marking of inserts and workshop trolleys. Apart from the economic benefits of reducing the assortment of tools to the needs of your individual job,

Bahco Tool Solutions offers additional advantages not only for technically sensitive applications. The personalisation of your tools is based on your specific allocation plan through laser-etched labelling that will provide long-term logistical and security benefits which you can count on. Bahco Tool Solutions: All-round efficiency.

Contents Page

Configuration software BETMS 4 – 5

Storage systems 6 – 7

Personalised tool assortments 8 – 9

Tool control and security 10 – 11



JOBS



► CONFIGURATION SOFTWARE Bahco Ergo Tool M

Designing your workshop trolley

- Frames in various colours and sizes
- Free combination of drawer and frame colours
- Variety of drawer capacities
- Selection of various work surfaces (stainless steel, wooden or rubberised surface)
- Additional accessories such as folding work surface, can holder etc.

Putting together your individual tooling selection

- Choice of tools from the comprehensive Bahco range
- Inclusion of existing tools possible
- Individual layout of tools in each draw

Personalising your tools

- Laser marking
- Development and manufacturing of essential tools

Personalised design of your tool tray inserts

- Sizes
- Cut-outs
- Layout
- Colours

Bahco's vision was nothing less than the total customisation of the workshop trolley and tool assortment to suit the requirements of the user.

In order to realise this vision, Bahco has developed BETMS: a software solution that enables the user to create their own optimal, personalised solution from Bahco's extensive range of tools, workshop trolleys and other storage solutions, as well as the tool assortment.



ERGO TOOL MANAGEMENT SYSTEM

Benefits

- Your assortment only contains the tools you actually use and makes it easy to quickly find the right tool
- Cost savings by eliminating unused tools or particular sizes included in standard assortments
- Laser engraving brings security benefits and helps to prevent theft
- Variety of trolley colour schemes can support your corporate design or individual company image

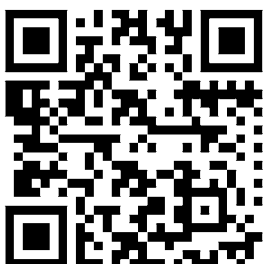
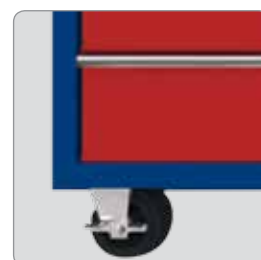
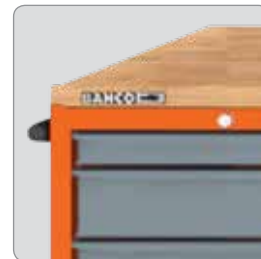

BETMS application video on YouTube



Bahco Tool Solutions areas of application on YouTube

Management System BETMS

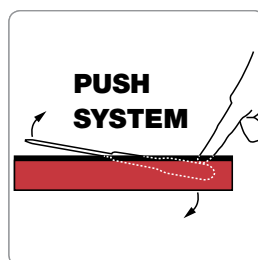
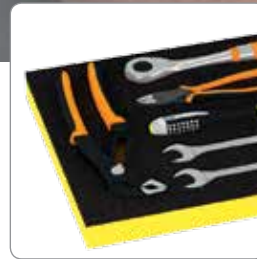

STORAGE SYSTEMS Workshop trolleys



The flexible workshop trolley range

The extensive range of high quality Bahco workshop trolleys is optimally directed towards the daily requirements of the professional user. Numerous workshop trolleys in different colours and with various combinations of drawers are available as standard stock items.

- Choice of work surfaces: stainless steel, rubber, solid wood
- Lock & Go locking system prevents the accidental opening of the drawers if the trolley is moved
- 2 fixed castors and 2 swivelling castors with brakes
- Fully openable drawers with ball-bearing slides
- Double wall frame. Drawers and slides will still work perfectly even if the frame gets damaged
- Load-bearing capacity: 900 – 1 000 kg
- Comprehensive range of accessories
- Drawer capacity: 45 kg



1475K Series
Standard colours



1470K Series
Standard colours

▶ TOOL CASES AND TOOLBOXES



Tool assortments for mobile applications

With a Bahco tool case or toolbox, you always have the most important tools to hand in every job.

Choose from either our proven standard assortment or ask us to help you put together one tailored to suit your requirements.

You will also benefit from our customised foam inserts:

You will be able to see at a glance which tool belongs where and whether one is missing – an important advantage when you are out on a job where you are unable to pick up a replacement.

Rigid cases:

- Stable tool case made from polypropylene
- With telescopic handle and wheels
- Resistant to temperature fluctuations, dirt and water
- Pressure equalisation valve
- Lockable and stackable with identification label



Metal toolboxes:

- Aluminium chequer plate case for safe grip and lid reinforcement
- Fully openable drawers
- Handles on sides and lid for safe transport
- Tool holders in lid for additional storage space



▶ PERSONALISED TOOL ASSORTMENTS Tools

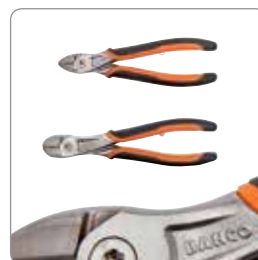
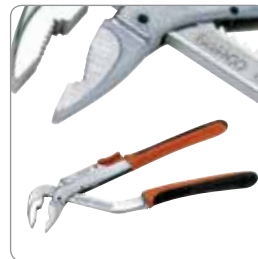
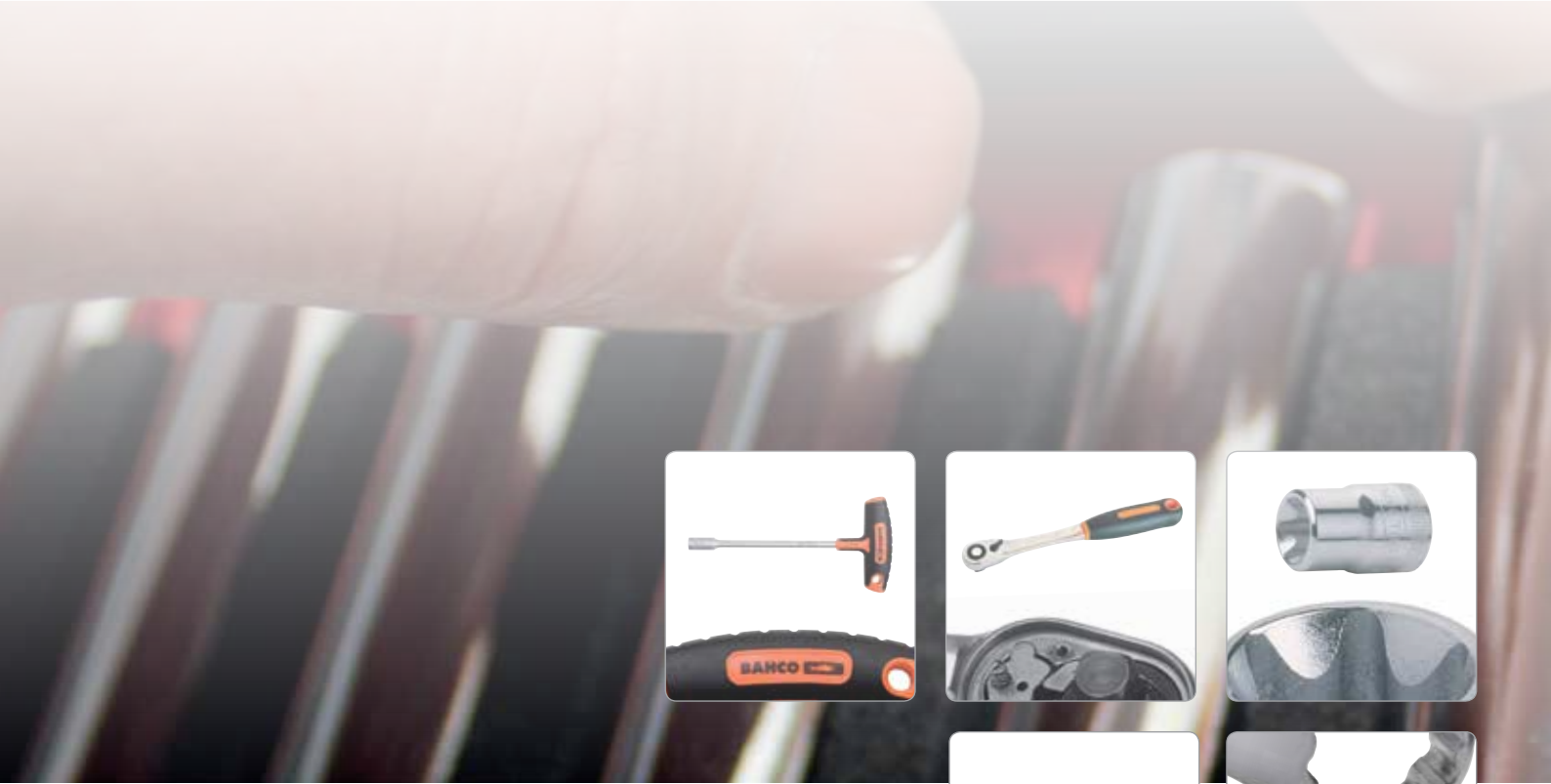

High quality hand tools

With an extensive range of over 15,000 products, 11 European production sites and over 150 years' experience in the development and production of hand tools, Bahco is your ideal partner for creating personalised tool solutions.

- Comprehensive range with more than 15.000 products
- More than 500 ergonomic hand tools
- More than 150 years' experience in the manufacture of hand tools



Efficiency and safety through ergonomic hand tools

Ergonomic hand tools provide the user with a high degree of control, comfort and precision.

All Bahco tools which carry the ERGO™ logo have been developed, tested and manufactured in accordance with our ERGO™ scientific development programme.

▶ TOOL TRAY INSERTS

FLEXIBLE LAYOUT



FLEXIBLE SHAPES



PUSH SYSTEM

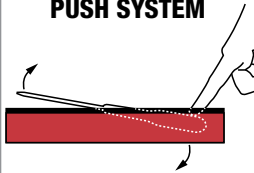

LOAD-BEARING BASE



CHOICE OF COLOURS

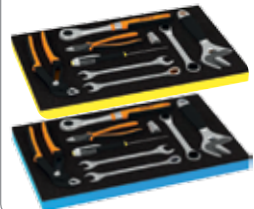

Configuring your individual tool inserts

- Flexible layout of tools in the foam
- Push System: simplified tool withdrawal through recesses
- Choice of foam colours
- Every tool has its own place:
bi-coloured foams enable rapid identification of a missing tool
- Customer-specific solutions possible

Selection of a proven standard assortment

- Choose from our proven standard range of products
- Available for both workshop trolleys and mobile applications



▶ TOOL CONTROL AND SECURITY Personalisation



Labelling of tools

Effective use and maximum reliability in many technical areas is absolutely essential today. Take aviation for example – with ever shorter ground times, security checks and maintenance work have to be precisely organised to ensure a smooth and error-free service.

So that every technician always has his equipment ready for use, we offer the option of personalising tools and inserts with laser etching. This also helps to prevent mix-ups or theft of equipment parts.

- Logo marking
- Coding with any combination of numbers and letters
- Anti-theft protection through ownership control
- Prevents mix-ups on large construction sites
- Cost savings by minimising tool shortages





Tool control

- Checking the completeness of tools in workshop trolleys in critical applications e.g. aviation, mechanical engineering, laboratory equipment technology, food industry
- Storage of any amount of information for individual allocation plans (person, trolley, field of work)





MOST FLEXIBLE SOLUTION



www.bahco.com



A registered trademark of SNA Europe Group

NEW GENERATION OF SOFT BAGS



Specifically developed to make your job easier

► BUILDERS OPEN BAG

4750FB1-19A

Velcro straps for long tools:
Spirit levels, tubes and similar longer material can be stored using those straps with the quick velcro system positioned in both upper side of the bag

Soft grip handle:
Made of rubberized material. Provides a user friendly grip and isolates from touching any cold material

HARD BOTTOM
100% waterproof



Measuring tape, card holder & phone pocket on one side

Hand saw special pocket:
With a zip and velcro strap for a quick storage, avoids any accident and / or lost during transport

Code: 4750FB1-19A

3100TB

600 x 400 x 400 mm

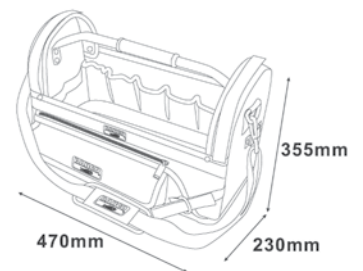

BUILDERS OPEN & CLOSE CASE ◀

4750FB1-19B

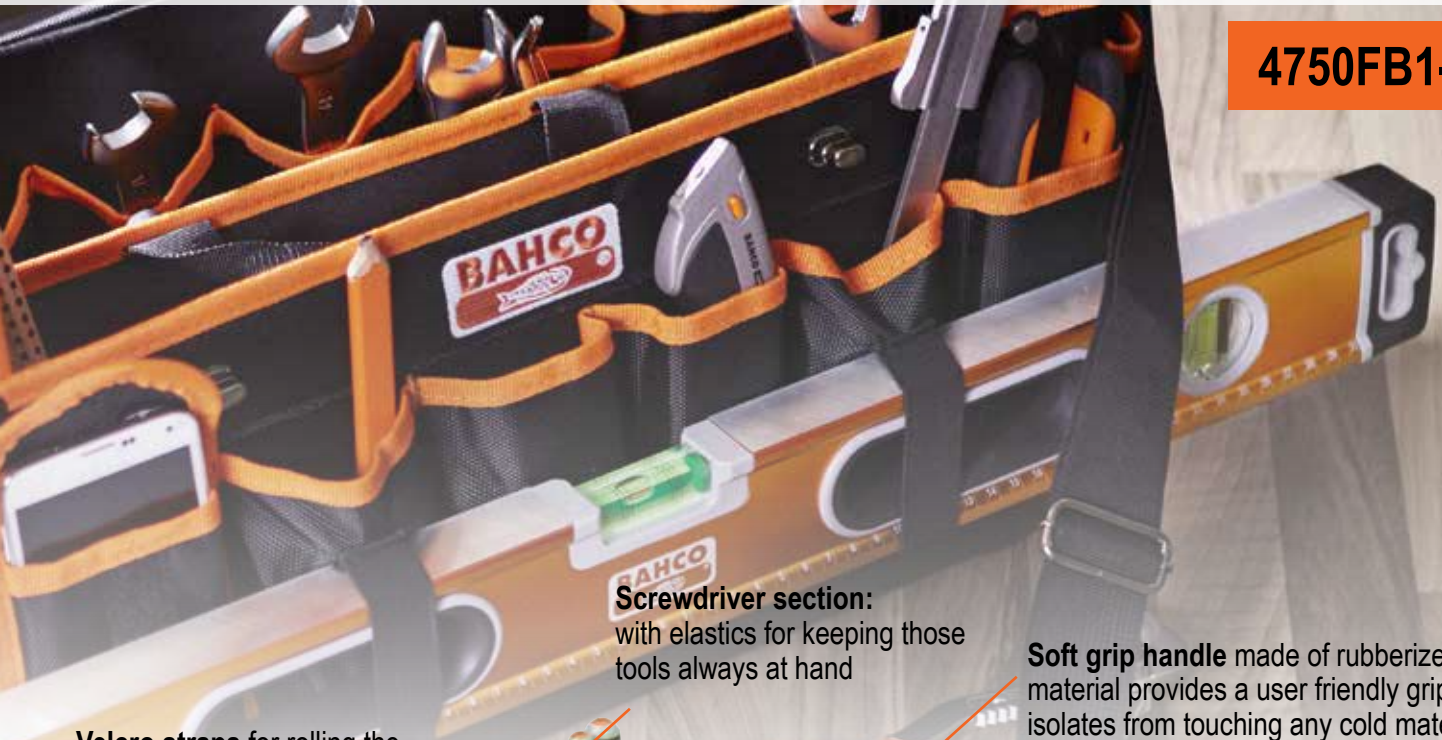

Screwdriver section:
with elastics for keeping those
tools always at hand

Soft grip handle made of rubberized
material provides a user friendly grip and
isolates from touching any cold material

Velcro straps for rolling the
cover: keeps the bag open
when necessary but, at the
same time, the handsaw and
other pockets can be still used

Measuring tape, card holder
& phone pocket on one side

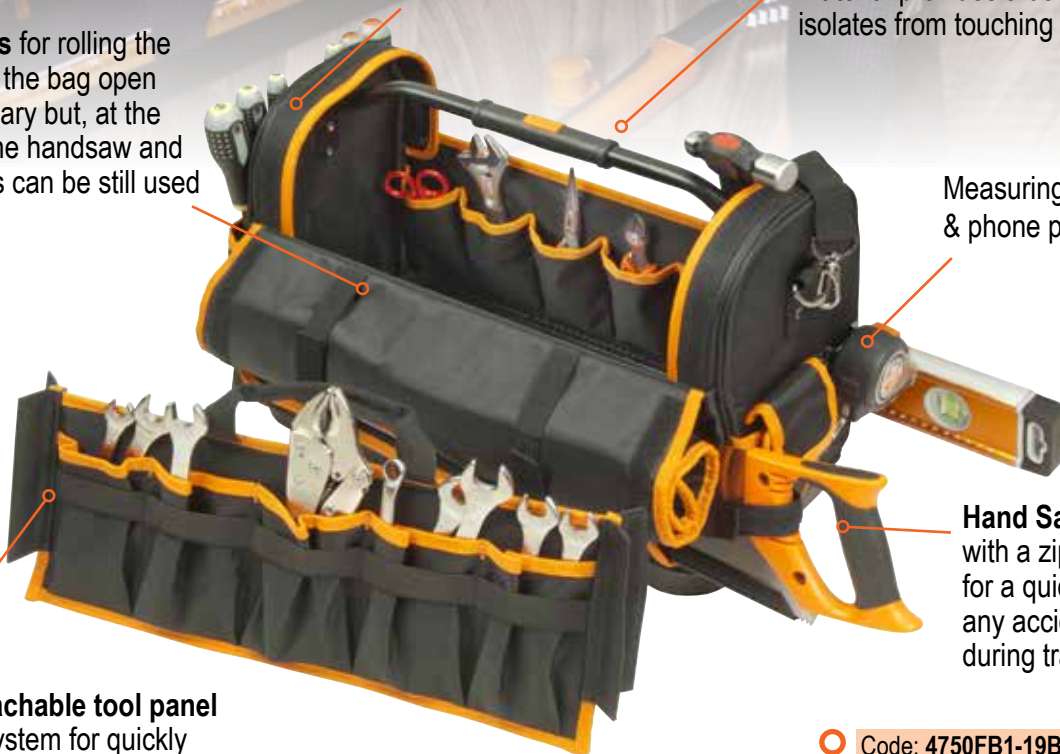

Hand Saw special pocket:
with a zip and velcro strap
for a quick storage, avoids
any accident and / or lost
during transport

Internal detachable tool panel
with velcro system for quickly
removing and bringing the needed
tools. Elastics and pockets included

Code: 4750FB1-19B

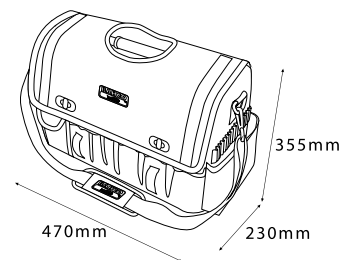

Softgrip handle access trough the cover

Velcro straps for long tools

Spirit level elastics
Holders on back side

Hard bottom: 100% waterproof



Specifically developed to make your job easier

▶ OPEN BAG WITH WHEELS

4750FB2W-24A



Multiple screwdrivers
Internal pocket section

Under lid net zipped
pocket for documents

10" Tablet
size specific pocket

Handsaw internal
zipped pocket

Elastic & velcro quick
adjustable straps
for long tools such as
spirit levels, tubes...

Side horizontal handles:
for easier pulling the bag
when stored in confine
places, pic ups, etc

Side big pouches:
Left one zipped detachable
Right fixed one includes
a plastic box for small
consumables: screws,
nuts, washers, terminals

HARD BOTTOM

100% waterproof



Telescopic handle:
960 mm max

Externally positioned pu
80 x 25 mm wheels:
For better stability and
Silent when rolling

Card holder

Code: 4750FB2W-24A

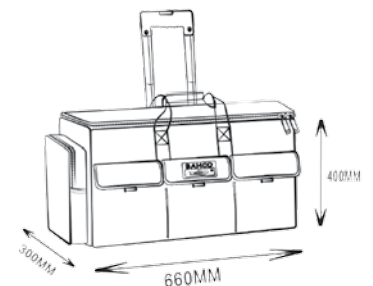

“THE ORIGINAL” CLOSE BAG ◀

4750FB2-19A

4750FB2-24A



Double heavy duty zips

Multiple internal and external pockets

4 practical pockets on one side

Handsaw internal holder (tip protector & handle velcro holder)

Quick adjustable straps for long tools such as spirit levels, tubes...

Measuring tape, card holder & phone pocket on one side

HARD BOTTOM

100% waterproof



Code: 4750FB2-19A

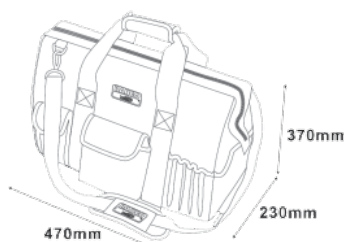

Code: 4750FB2-24A

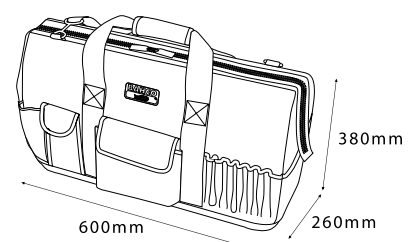

Specifically developed to make your job easier

▶ LAPTOP TOOLS BAG

4750FB4-18

Divers height pockets and sections in each compartment allows a better tool distribution and to bring only one to the work place for avoiding carrying a heavy bag

Document pocket in each side detachable compartment

Central big padded compartment for laptop and similar delicate material and two detachable side sections

Measuring tape, card holder & phone pocket on one side



Side detachable compartment: each one has its own design for better covering the needs of each user



HARD BOTTOM
100% waterproof



Code: 4750FB4-18

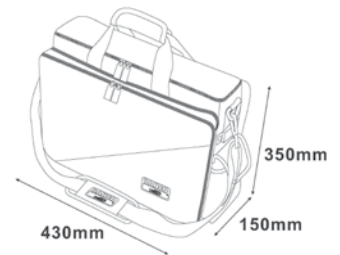

ELECTRICIAN BAG ◀

4750FB3-12



Multiple screwdrivers elastic section
In front and back side

Divers height pockets
replicated in both sides

HARD BOTTOM
100% waterproof



Hd reinforced handle
provides stability and strength the bag

Central big compartment
for bigger tools or material

Measuring tape, card holder & phone pocket on one side

Big bottom pocket
Including a plastic box for small consumables: screws, nuts, washers, terminals

▶ BAHCO FOLDERS



- Measuring tape holder
- Rubber soft handle
- **Multiple elastics** for tool distribution in the bottom and upper side
- **Card holder** on front and labelling holder on the side for quick identification

Code: 4750FB3-12



Specifically developed to make your job easier

▶ PLASTIC TOOL BOXES

4750PTB60

600 x 305 x 295 mm

Capacity 37 liters



Made of virgin polypropylene (pp)
What makes the box really
**Heavy duty even if used
under extreme conditions**

The aluminum handle facilitates transportation. If you lift the handle, the bottom part is blocked, preventing the box from opening accidentally

Internal tray is very helpful for taking only the needed tools into the area or keeping it tidy

Locking system:

Even if the latches are open, when the alu handle is in vertical position blocks the bottom part of the box avoiding the box to open accidentally

4750PTB50

500 x 295 x 270 mm

Capacity 27 liters



Sturdy and big load capacity:

The design of the box, with Nerves and specific shapes on The corners make it more sturdy increasing the load capacity

1496MB2

530 x 290 x 290 mm

1496MB3

690 x 360 x 310 mm

1496MB4

910 x 530 x 530 mm

1496MB5

830 x 440 x 340 mm



MASON BOX

- HD constructions with weld points in key areas for making the box robust
- Internal protection using a 3.2mm thick plywood with anti-humidity treatment
- Combination of 0.8mm and 1.0mm thickness steel on the stressed areas for avoiding any deformation
- All boxes are including a tool tray which helps the user to carry the needed tools
- Orange powder coating with a texture finishing that is more resistant to the toughest working environments

4750PTBW47

470 x 290 x 630 mm

Capacity 60 liters



BAHCO



www.bahco.com

SNA Europe B&C-1272-INT

Bahco is a registered trademark of SNA Europe Group



A registered trademark of SNA Europe Group



WORKBENCHES AND CABINETS



▶ CABINETS

1495SC15

1500 x 170 x 900 mm

1495SC18

1800 x 170 x 900 mm

1495CD60

605 x 250 x 900 mm



Compact structure

The steel frame and grid make it very robust and capable to load it heavily

Rolling system

Can be easily rolled down using the two handles available

Locking system

The cabinet can be easily closed and even secured with a key

Perforated panel on sides

User can store any specific tools/ thing. 100% opening slides provide full access



▶ BUILD UP YOUR OWN WORKBENCH!

1495WB15TS

1495WB18TS

1495WB15TD

1495WB18TD

1495WB15TW

1495WB18TW

1500 x 750 x 1030 mm

1800 x 750 x 1030 mm

Choose from the extensive Bahco standard 1470K S

▶ Wooden top:

With 40mm thickness and varnished finished for long lasting, absorbs very well impacts and lubricants

▶ Steel top:

With 2mm thickness, it is strategically bended for making it very strong and heavy duty



▶ ACCESSORIES

1495WB-AC1

500 x 500 x 105 mm

1495WB-AC2

570 x 528 x 160 mm

1495WB15-AC1

1500 x 504 x 30 mm

1495WB18-AC1

1800 x 504 x 30 mm



Includes metallic dividers
Can be assembled in any of the sizes



Bottom tray

Provides storing surface for boxes, cases and similar bulky things

TOOL PANELS

1495TP06

600 x 25 x 500 mm

1495TP12

1200 x 25 x 800 mm

1495TP15

1500 x 25 x 800 mm

1495TP18

1800 x 25 x 800 mm

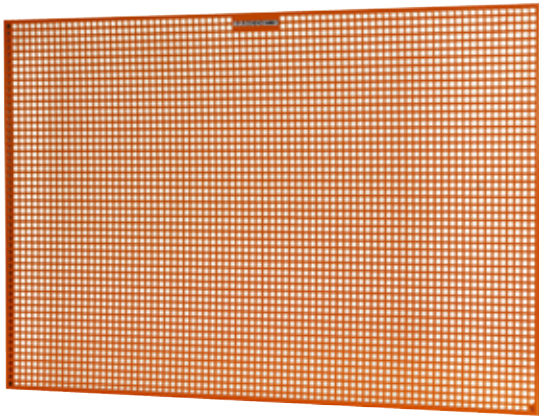

Sturdy frame:

The panel has a frame which is bended in the edges in order to be able to stand and be mounted in walls. Stands big loads without having any deformation

Accessories:

1495CS-AC1 / 1495CD-AC1 includes 35 and 24 different hooks which is a good base for the majority of the users. Available for all cabinets and panels

1495TP-AC1 accessory is used for attaching the tool panels to workbenches with wooden or MDF tops

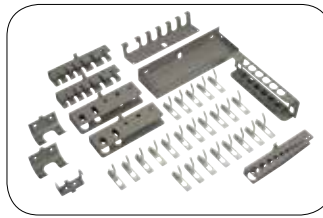

1495CS-AC1

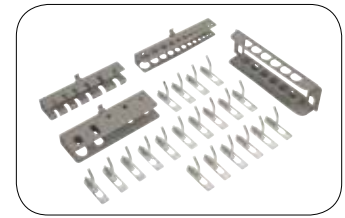

1495CD-AC1

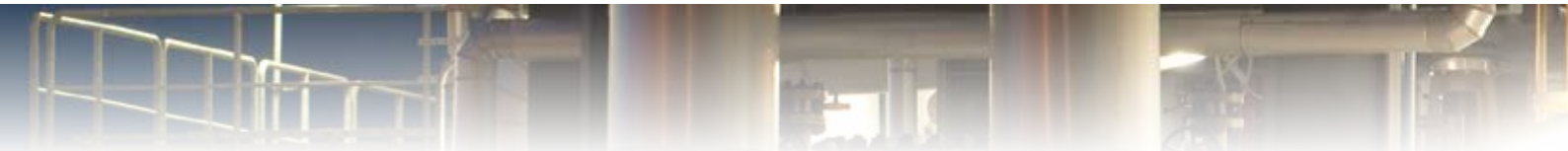

Series trolley solutions by selecting

1 Dimensions: 1500 mm, 1800 mm

2 Number of drawers: 5, 6, 7, 8

3 Colours: orange, red, blue and black

4 Tops: wooden, MDF, steel

MDF top:

With 40mm thickness, it is very consistent in strength and size

Structure:

The U shape provides robustness

The H shape welded feet brings strength to the workbench

Assembly is easy and quick

The feet has a flat shape for higher stability

Includes anti slippery vulcanized rubber for safety

Load capacity: 1,5T



1470K Series features and benefits:

Heavy duty construction with strong reinforcement in key areas

Total static load capacity: 600 kg

Long ball bearing slides

100% opening drawers

Load capacity per drawer: 30 kg

Double wall frame

Drawers and slides work even if the frame gets damaged

		1500 MM				1800 MM			
		Orange	Red	Black	Blue	Orange	Red	Black	Blue
MDF	5	1495K5WB15TD	1495K5REDWB15TD	1495K5BKWB15TD	1495K5BLWB15TD	1495K5WB18TD	1495K5REDWB18TD	1495K5BKWB18TD	1495K5BLWB18TD
	6	1495K6WB15TD	1495K6REDWB15TD	1495K6BKWB15TD	1495K6BLWB15TD	1495K6WB18TD	1495K6REDWB18TD	1495K6BKWB18TD	1495K6BLWB18TD
	7	1495K7WB15TD	1495K7REDWB15TD	1495K7BKWB15TD	1495K7BLWB15TD	1495K7WB18TD	1495K7REDWB18TD	1495K7BKWB18TD	1495K7BLWB18TD
	8	1495K8WB15TD	1495K8REDWB15TD	1495K8BKWB15TD	1495K8BLWB15TD	1495K8WB18TD	1495K8REDWB18TD	1495K8BKWB18TD	1495K8BLWB18TD
WOODEN	5	1495K5WB15TW	1495K5REDWB15TW	1495K5BKWB15TW	1495K5BLWB15TW	1495K5WB18TW	1495K5REDWB18TW	1495K5BKWB18TW	1495K5BLWB18TW
	6	1495K6WB15TW	1495K6REDWB15TW	1495K6BKWB15TW	1495K6BLWB15TW	1495K6WB18TW	1495K6REDWB18TW	1495K6BKWB18TW	1495K6BLWB18TW
	7	1495K7WB15TW	1495K7REDWB15TW	1495K7BKWB15TW	1495K7BLWB15TW	1495K7WB18TW	1495K7REDWB18TW	1495K7BKWB18TW	1495K7BLWB18TW
	8	1495K8WB15TW	1495K8REDWB15TW	1495K8BKWB15TW	1495K8BLWB15TW	1495K8WB18TW	1495K8REDWB18TW	1495K8BKWB18TW	1495K8BLWB18TW

FOLDABLE WORKBENCH

1495FWB097TS

970 x 500 x 840 mm

Galvanized Top

1495FWB120TS

1200 x 500 x 840 mm

Galvanized Top

1495FWB097TD

970 x 500 x 840 mm

MDF + Galvanized Top

1495FWB120TD

1200 x 500 x 840 mm

MDF + Galvanized Top

Load Capacity:
300 kg

Compact structure:
Scissor system: compact bridges provide strength and stability



Rubber handle

Plastic caps in structure top sides:
Make the top mounting easy and tight for avoiding any movement while working

Plastic caps in structure's feet:
Provide stability and avoids any slippery situation regardless the surface we are working on



TOOL PANEL WITH WHEELS

1495TP10W

1000 x 450 x 1500 mm

Wheels with brake
(2) for avoiding any unexpected movement

Accessories:
1495CS-AC1 / 1495CD-AC1 includes 35 and 24 different hooks which is a good base for the majority of the users



Tray on top just for storing any screw, nut, etc

Handles in both sides for easy moving the trolley and providing more safety

Spacious bottom compartment for storing bulky tools, products, tanks or similar

Load Capacity:
300 kg

CABINET WITH 2 DOORS ON WHEELS

1495CD60W

760 x 250 x 1500 mm

Compact structure
1mm & 2mm sheet metal
The steel frame makes it very robust and capable to load it heavily

Reinforced roll cart brings flexibility for moving around the cabinet as well as enlarging the storage capacity thanks to the two trays

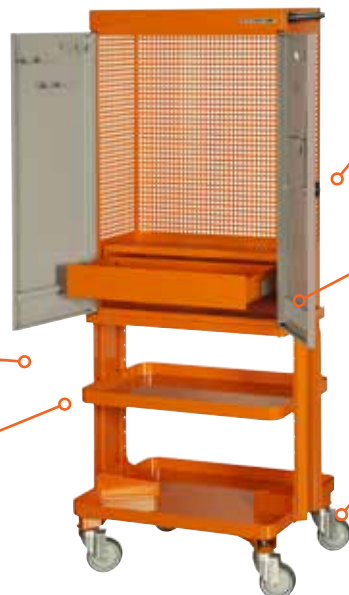

Locking system
The cabinet can be easily closed and even secured with a key

The doors are opened 180° for full access

Wheels with brake
(2) for avoiding any unexpected movement

Accessories:
1495CS-AC1 / 1495CD-AC1 includes 35 and 24 different hooks which is a good base for the majority of the users



A registered trademark of SNA Europe Group

Pouches and Belts



▶ TABLE OF CONTENT



Electrician's Pouch
4750-EP-1 p. 9



Drill Holster Right & Left Hand
4750-DHO-3 p. 10



Hammer Holder
4750-HHO-2 p. 11



Multi Purpose Holder
4750-MPH-1 p. 12



Universal Pouch
4750-UP-1 p. 13



Two Pocket Fixings Pouch
4750-2PP-1 p. 14



Vertical Smartphone Holder
4750-VMPH-1 p. 15



Knife Holder
4750-KNHO-1 p. 16



Knife Holder For ERGO™ Series
4750-KNHO-0 p. 17



Heavy Duty Belt With Cushion **4750-HDB-2 p. 18**



Quick Release Fabric Adjustable Belt
4750-QRFB-1 p. 19



Heavy Duty Leather Belt
4750-HDLB-1 p. 19



*Heavy Duty Belt Set
4750-HDBS-2 p. 22*

*3 Pouch Belt Set
4750-3PB-1 p. 23*



*Tool Case Tube
4750-TOCST-1 p. 25*



*Folding Front Leather Tool Case
4750-FOLTC-1 p. 26*



*Roll Cover For Tools
4750-ROCO-1 p. 27*



*Lopper Holster
PROF-LOPP p. 28*



*Secateur Holster
PROF-SEC p. 29*



*Anti Slip Knee Pads
4750-KP-1 p. 30*



*Braces With Clips
4750-BWC-1 p. 31*

▶ MATERIAL & TECHNICAL SOLUTIONS

The best materials and technologies to suit the needs of the user

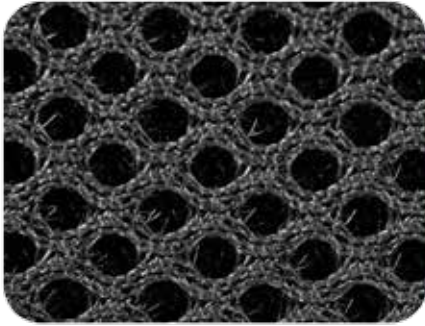

Black 3D Air Mesh



Polyester 600D

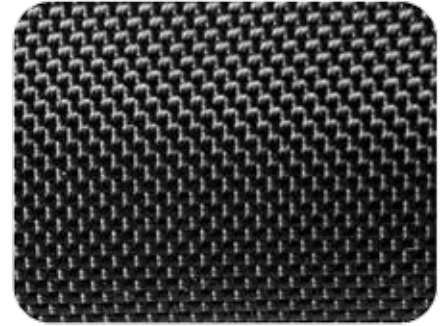

Polyester 1680D

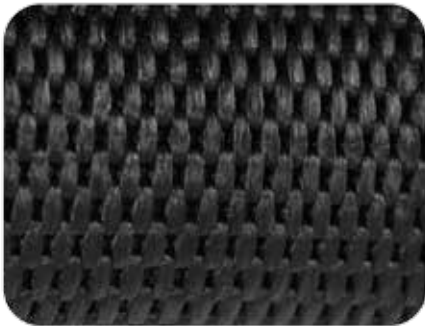

Polypropylene Tape



Polypropylene Sheet



High Grade Leather



Dual Layer of Waterproof material

Polypropylene Sheet

Synthetic Leather



Suede Leather

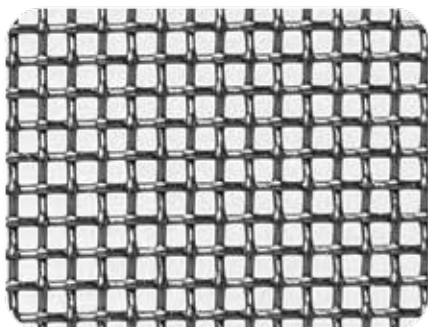

Net Pocket



Thick Foam



Black Rivets with Washers



Side Gate Hammer Holder



Cushioned Shoulder Pad



Measuring Tape Clip



Plastic Handle



Steel Buckle



High Quality Zipper



Lock with Key



Metal Buttons



▶ ELECTRICIAN'S POUCH

4750-EP-1

General features

Fits any Bahco tool belt or normal clothing belt. Universal tool loop for your bigger tools to keep them organized. Chain hook for an easy access to insulation tapes or flex. Main deep pocket for safe storage of long tools and fixings, etc. Additional pocket for smaller tools gives easy tool access. Real leather slots on the sides ideal for holding longer tools i.e. screwdrivers, knives. Necessary equipment is at hand when needed. Made of strong 1680 denier polyester.



Technical Information:

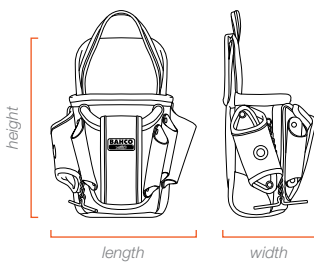

	<i>metric</i>
<i>height:</i>	300 mm
<i>length:</i>	270 mm
<i>width:</i>	150 mm
<i>weight:</i>	0,520 kg
<i>volume:</i>	2,500 l

Outside features:

Specifically researched design to carry a full range of specialized electrical tools.



▶ DRILL HOLSTER RIGHT & LEFT HAND

4750-DHO-3

General features

Holds any standard sized cordless or mains powered drills. Suits left and right handed users as well as forward and backward facing machines. Rubber slots on the top ideal for storing drill bits.



Technical Information:

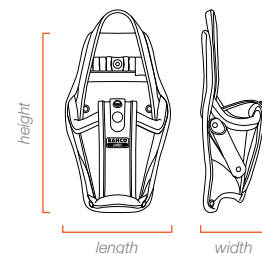

	metric
height:	290 mm
length:	170 mm
width:	90 mm
weight:	0,260 kg
volume:	01

Outside features:

Genuine leather strap with a metal button holds the drill safely when climbing on or off a scaffolding.

▶ HAMMER HOLDER

4750-HHO-2

General features

Fits any Bahco tool belt or normal clothing belt. Useful while working with the hands up, when the quick access to tools is needed. Made of strong 1680 denier polyester. Swings to keep your hammer at a comfortable angle.



Outside features:

Solution with side gate lets you easily put the tool in without looking at the holder. Keeps all kinds of common hammers used on building site.

Technical Information:

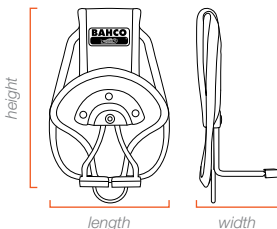

	metric
height:	180 mm
length:	120 mm
width:	70 mm
weight:	0,170 kg
volume:	0l



Includes ring for Tools at Height safety system

▶ MULTI PURPOSE HOLDER

4750-MPH-1

General features

Riveted for truly unbreakable strength. Measuring tape clip for any common builder's tape measure from 3 to 10 meters long. Made of strong 1680 denier polyester. Extra leather slot in the middle for a pen or a small screwdriver. Ideal item to be added to your own creation of Tool Belt Set together with other products.



Technical Information:

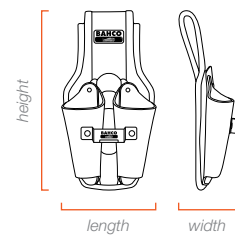

	metric
height:	240 mm
length:	170 mm
width:	60 mm
weight:	0,220 kg
volume:	01

Outside features:

Leather slots ideal for holding different types of tools i.e. knives, screwdrivers.

▶ UNIVERSAL POUCH

4750-UP-1

General features

Fits any Bahco tool belt or normal clothing belt. Riveted for truly unbreakable strength. Real leather slots ideal for holding longer tools. Elastic straps inside big pockets for better tool organization. Necessary equipment is at hand when needed. Measuring tape clip for any common builder's tape measure from 3 to 10 meters long. Made of strong 1680 denier polyester.



Technical Information:

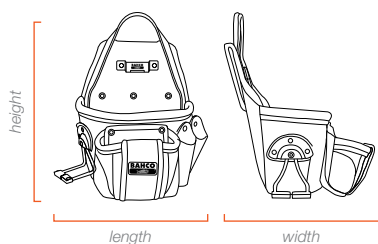

	<i>metric</i>
<i>height:</i>	260 mm
<i>length:</i>	290 mm
<i>width:</i>	180 mm
<i>weight:</i>	0,550 kg
<i>volume:</i>	2,000 l

Outside features:

Two deep multi-purpose open pockets provide for quick tool identification...



▶ TWO POCKET FIXINGS POUCH

4750-2PP-1

General features

Perfectly positioned wide pockets hold plenty of fixings and provide quick tool recognition. Fits any Bahco tool belt or normal clothing belt. Necessary equipment is at hand when needed. Made of strong 1680 denier polyester. Elastic straps inside big pockets for better tool organization.



Technical Information:

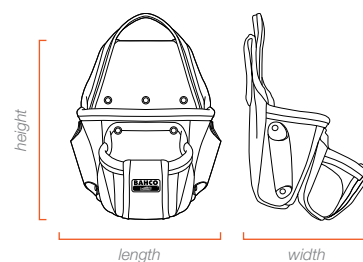

	metric
height:	260 mm
length:	260 mm
width:	180 mm
weight:	0,370 kg
volume:	2,000 l

Outside features:

General shape with rigid pocket sides designed to keep the pouch stable and vertical, preventing tools and fixings from falling out.

▶ VERTICAL SMARTPHONE HOLDER

4750-VMPH-1

General features

Closed by Velcro® for greater security. Made of strong 1680 denier polyester. Fits any belt from the Bahco range and the majority of the actual smartphones in the market. Fits any belt from the Collection. Works also without the belt.



Technical Information:

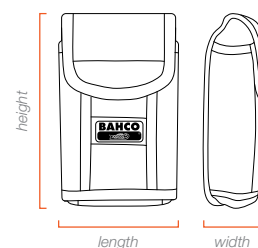

	<i>metric</i>
<i>height:</i>	160 mm
<i>length:</i>	100 mm
<i>width:</i>	35 mm
<i>weight:</i>	0,080 kg
<i>volume:</i>	0,120 l

Outside features:

Universal mobile phone holder with a flap for extra protection on a building site.

▶ KNIFE HOLDER

4750-KNHO-1

General features

Finished with an extra layer of suede leather to ensure resistance to years of wear and tear. Necessary equipment is at hand when needed. Riveted for truly unbreakable strength. Made of strong 1680 denier polyester. Fits any belt from the Collection.



Technical Information:

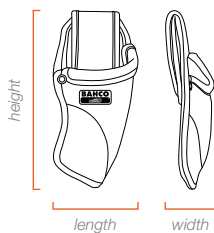

	<i>metric</i>
<i>height:</i>	200 mm
<i>length:</i>	100 mm
<i>width:</i>	50 mm
<i>weight:</i>	0,090 kg
<i>volume:</i>	0,100 l

Outside features:

Unique shape of this holder specifically designed to suit the utility knives

▶ KNIFE HOLDER FOR ERGO™ SERIES

4750-KNHO-0

General features

Fits perfectly into small knives. Necessary equipment is at hand when needed. Made of strong 600 denier polyester. Fits any belt from the Collection.



Technical Information:

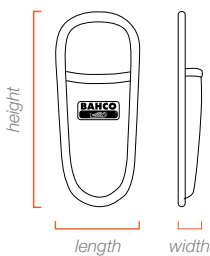

	metric
height:	210 mm
length:	85 mm
width:	20 mm
weight:	0,080 kg
volume:	0,080 l



▶ HEAVY DUTY BELT WITH CUSHION

4750-HDB-2

General features

Features a Heavy Duty Leather Belt with stainless steel twin-pin buckle. Made of strong 1680 Denier polyester with polyethylene backing. Riveted for truly unbreakable strength. Perfect foundation for building your customized tool belt. Fully padded by 3D mesh breathable material for extra comfort when carry the heaviest complement of tools and waist protection.



Technical Information:

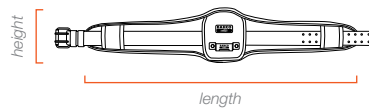

	<i>metric</i>
<i>height:</i>	190 mm
<i>length:</i>	900 mm
<i>width:</i>	50 mm
<i>weight:</i>	0,650 kg
<i>volume:</i>	0,250 l



▶ QUICK RELEASE FABRIC ADJUSTABLE BELT

4750-QRFB-1

General features

Fits perfectly into small knives. Necessary equipment is at hand when needed. Made of strong 600 denier polyester. Fits any belt from the Collection.



Technical Information:

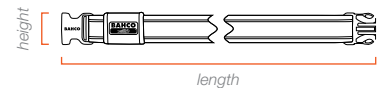

	metric
height:	50 mm
length:	1200 mm
width:	0 mm
weight:	0,310 kg
volume:	0l

▶ HEAVY DUTY LEATHER BELT

4750-HDLB-1

General features

Simple design and flexibility of the belts helps in easy using. Our belts are made of the high quality materials such as high grade leather or 1680 denier polyester. Our belts are design in the universal sizes so they fit any weight.

Technical Information:

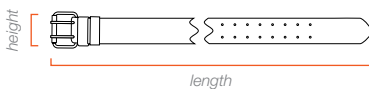

	metric
height:	50 mm
length:	1290 mm
width:	0 mm
weight:	0,300 kg
volume:	0l



▶ CREATE YOUR OWN TOOL BELT SET

1

Choose Pouches

Each Pouch is designed for different tools. Find out which tools you are using mostly and choose the best pouch.



Follow four easy steps to have your personalised tool belt set.



2 Add Belt

You have three different belts to choose from. The belt will be a base of your belt set.



3 Contact with Us

If you need any advice, we offer our wide experience in combining belts and pouches together. Just contact us and we will advise you how to create the most practical and useful tool belt set to suit your needs. Different kinds of jobs require different tools and consequently different carrying systems.

4 Get your own belt set

Now you are ready to use your own tool belt set according to your needs.



▶ HEAVY DUTY BELT SET

4750-HDBS-2

General features

The ultimate tool belt system is made from a combination of tough nylon and high grade plus synthetic stitching and riveted reinforcement. Moveable components, you can easily take out the pockets from the belt. Fully padded belt by 3D mesh breathable material for extra comfort when carrying heavy tools.

Technical Information:

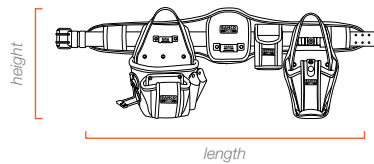

	<i>metric</i>
<i>height:</i>	360 mm
<i>length:</i>	900 mm
<i>width:</i>	160 mm
<i>weight:</i>	1,550 kg
<i>volume:</i>	2,250 l



Outside features:

Fits waist sizes from 80 cm to 120 cm (32" to 48")

▶ 3 POUCH BELT SET

4750-3PB-1

General features

5 handy pockets to cover most trade applications. Strong construction with riveted reinforcement – for truly industrial strength with galvanized washers top and bottom. Easy to adjust comfortable nylon belt with 50 mm polypropylene quick release buckle.



Outside features:
Strong construction with riveted reinforcement.



	<i>metric</i>
<i>height:</i>	260 mm
<i>length:</i>	650 mm
<i>width:</i>	180 mm
<i>weight:</i>	1,230 kg
<i>volume:</i>	4,500 l

Technical Information:

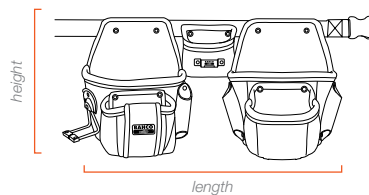



▶ TOOL CASE TUBE

4750-TOCST-1

General features

Made of synthetic leather. Long internal pocket in the main compartment. Rubber carry handle, simple alternative solution to carrying bag on your shoulder. Leather closing straps instead of metal locks let us adjust the bag for tools that might be even longer than a case and would stick out.



	<i>metric</i>
<i>height:</i>	260 mm
<i>length:</i>	500 mm
<i>width:</i>	270 mm
<i>weight:</i>	2,980 kg
<i>volume:</i>	24,000 l

Technical Information:

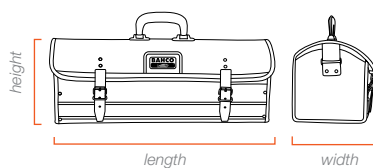

Outside features:
Perfect for storing long tools.

▶ FOLDING FRONT LEATHER TOOL CASE

4750-FOLTC-1

General features

Open design for quick and easy access. External pocket for documents. Adjustable heavy-duty shoulder belt, easy to unfasten when it is not needed. Shoulder pad makes carrying the bag nicer when it is full. Made of strong synthetic leather. Leather strap inside for better tool organization. Plastic handle enables carrying the bag when is full.



Technical Information:

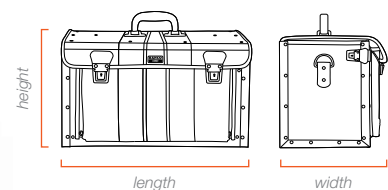

	metric
height:	260 mm
length:	440 mm
width:	210 mm
weight:	2,900 kg
volume:	22,000 l

Outside features:

Aluminum corner reinforcements for longer life of bag and protecting the front panel when it is opened on the floor.

▶ ROLL COVER FOR TOOLS

4750-ROCO-1

General features

Made of soft 1680D polyester. Designed to store all of the small tools and pieces of gear that seem to get lost in the bottom of bags. Elasticated tool securing band prevent tools from falling out giving you safety storage.



	<i>metric</i>
<i>height:</i>	380 mm
<i>length:</i>	320 mm
<i>width:</i>	50 mm
<i>weight:</i>	0,300 kg
<i>volume:</i>	01

Technical Information:

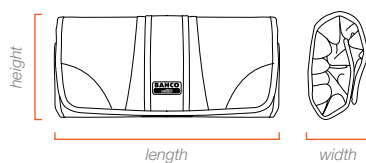

Outside features:

Velcro® system

▶ LOPPER HOLSTER

PROF-LOPP

General features

PVC coated polyester fabrics lining to give extra strength and protect the holster before damage in hard orchard conditions. Additionally this fabric doesn't tear when it is cut. Made of strong and durable 35mm width elastic rubber straps are easy to put on. Universal size thanks adjustable strong Velcro® tape stitched to each strap. Pocket on the front side for easy access to smaller tools or things. Perfect for sharpening stone. Also PVC coated polyester fabrics for longer life.



Technical Information:

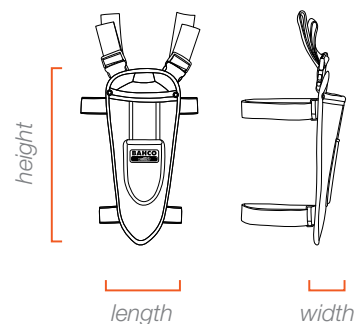

	metric
height:	370 mm
length:	160 mm
width:	50 mm
weight:	0,370 kg
volume:	0l

▶ SECATEUR HOLSTER

PROF-SEC

General features

Multipurpose – two pockets in two sizes. Most of basic tools used in Orchard or Garden can be put inside. Made of strong polyester 1680D. The pouch sits comfortably on any belt from the collection. Perfectly positioned two open pockets provide quick tool location and easy use.



Technical Information:

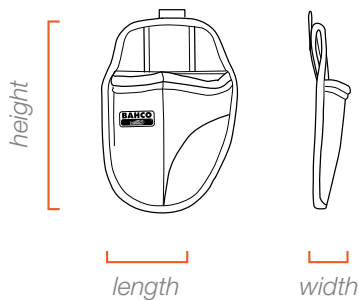

	metric
height:	230 mm
length:	160 mm
width:	50 mm
weight:	0,130 kg
volume:	0l

▶ ANTI SLIP KNEE PADS

4750-KP-1

General features

Universal lightweight knee pads for different kinds of surfaces. Heavy Duty rubber cups ensure comfort and safety when used in difficult conditions. Elastic straps with hook-and-loop fasteners for easy adjustment to leg sizes. Breathable 3D Air Mesh material lining provides maximum cushioning for all day of wearing.



Outside features:

Flexible knee pads, made from rubber and polyester 1680 denier ideal for most applications including general construction, use on uneven surfaces and for laying carpets, floor tiles and flooring etc.



Technical Information:

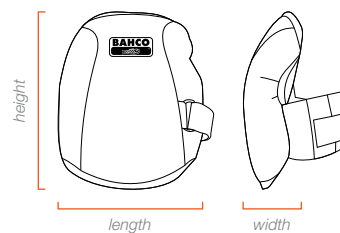

	<i>metric</i>
<i>height:</i>	160 mm
<i>length:</i>	220 mm
<i>width:</i>	70 mm
<i>weight:</i>	0,300 kg
<i>volume:</i>	01



▶ BRACES WITH CLIPS

4750-BWC-1

General features

Designed to transfer weight from waist to shoulders. Universal size. Fully cushioned pad provides for comfortable wearing. Heavy-duty steel fastening clips. Made of strong and durable elastic rubber.



Technical Information:

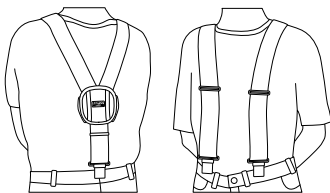

	<i>metric</i>
<i>height:</i>	0 mm
<i>length:</i>	50 mm
<i>width:</i>	0 mm
<i>weight:</i>	0,200 kg
<i>volume:</i>	0 l

Outside features:
Straps equipped with two metal buckles for perfect adaptation to the body shape.

PACKING INFORMATION

	<i>P-Number</i>	<i>Description</i>	<i>Quantity</i>	<i>Size of Box (mm)</i>	<i>Size of Box (in)</i>	<i>Gross Weight (kg)</i>	<i>Gross Weight (lb)</i>
1	4750-EP-1	Electrician's Pouch	35	780x590x440	30.75x23.25x17.25	20.20	44.53
2	4750-DHO-3	Drill Holster Right & Left Hand	40	590x390x440	23.25x15.25x17.25	10.50	23.15
3	4750-HHO-2	Hammer Holder	70	590x390x220	23.25x15.25x8.75	12.10	26.67
4	4750-MPH-1	Multi Purpose Holder	60	590x390x440	23.25x15.25x17.25	14.50	31.97
5	4750-UP-1	Universal Pouch	35	780x590x440	30.75x23.25x17.25	18.10	39.90
6	4750-2PP-1	Two Pocket Fixings Pouch	40	780x590x440	30.75x23.25x17.25	16.80	37.04
7	4750-VMPH-1	Vertical Smartphone Holder	120	590x390x440	23.25x15.25x17.25	13.30	29.32
8	4750-KNHO-1	Knife Holder	100	590x390x220	23.25x15.25x8.75	9.90	21.82
9	4750-KNHO-0	Knife Holder For ERGO™ Series	250	590x390x220	23.25x15.25x8.75	20.90	46.08
10	4750-HDB-2	Heavy Duty Belt With Cushion	25	590x390x440	23.25x15.25x17.25	16.30	35.93
11	4750-QRFB-1	Quick Release Fabric Adjustable Belt	80	590x390x440	23.25x15.25x17.25	20.50	45.19
12	4750-HDLB-1	Heavy Duty Leather Belt	40	590x390x220	23.25x15.25x8.75	12.50	27.55
13	4750-HDBS-2	Heavy Duty Belt Set	15	780x590x440	30.75x23.25x17.25	20.30	44.75
14	4750-3PB-1	3 Pouch Belt Set	20	780x590x440	30.75x23.25x17.25	18.40	40.56
15	4750-TOCST-1	Tool Case Tube	8	780x590x440	30.75x23.25x17.25	13.20	29.10
16	4750-FOLTC-1	Folding Front Leather Tool Case	16	1180x780x560	46.50x30.75x22.00	48.50	106.92
17	4750-ROCO-1	Roll Cover For Tools	50	590x390x440	23.25x15.25x17.25	16.30	35.93
18	PROF-LOPP	Lopper Holster	70	780x590x440	30.75x23.25x17.25	27.90	61.51
19	PROF-SEC	Secateur Holster	70	590x390x440	23.25x15.25x17.25	10.40	22.93
20	4750-KP-1	Anti Slip Knee Pads	40	590x390x440	23.25x15.25x17.25	13.70	30.20
21	4750-BWC-1	Braces With Clips	30	590x390x220	23.25x15.25x8.75	6.90	15.21



www.bahco.com



MODULAR SYSTEM

Each tool in the right place!



ERGO TOOL MANAGEMENT SYSTEM

Bahco has developed a new Modular System based on: Aviation, Auto Repair, Industrial Maintenance, General Industry and other Critical Industries.

Thanks to the new Modular System, customer will be able to create his own composition by using 1/3, 2/3 and 3/3 modules. Bahco offers 141 modules with following split:

49 modules	1/3
26 modules	2/3
71 modules	3/3

In case customer wants to further customize any of those 141 modules; BETMS configurator gives the option of ungrouping them and building up a customized composition based on the Bahco Handtools and Metal Cutting Tools Assortment.

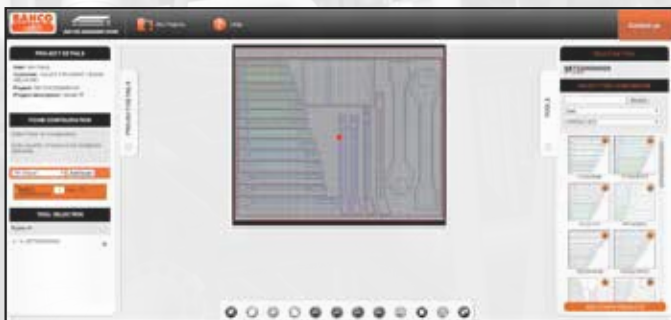

These range of modules have been developed and it is based on 26" Bahco Trolleys:

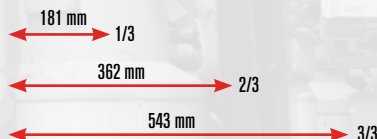

- 100% FOD
- Extra deeper hole in the insert facilitates to take out the tool

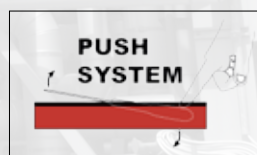

Inlays properties

- Underlay is red, overlay is black. A visible red, means that a tool is missing
- You can easily identify the missing tool thanks to the accurately designed shape
- Resistant to oil and grease
- Easy to clean



MIX
1/3 MODULE MIX COMPOSITION



ERGO TOOL MANAGEMENT SYSTEM



FF1E5001 - 7 pcs

MTB-5-25 5M TAPE MEASURE 25 mm

8045LVDE VOLTAGE TESTER VDE 0,5 X 3,5 X 42

WR2-MM 2M MM ONLY WOOD RULE

1544 FEELER GAUGE

1178-SCRIBE SCRIBER CARB.TUNGSTEN

5515T TELESCOPIC MIRROR

1150D DIGITAL CALIPER



FF1E5002 - 11 pcs

3740-150 FLAT CHISEL

3740-175 FLAT CHISEL

3740-200 FLAT CHISEL

3734-2 COTTER PIN PUNCH

3734-3 COTTER PIN PUNCH

3734-4 COTTER PIN PUNCH

3734-5 COTTER PIN PUNCH

3734-6 COTTER PIN PUNCH

3734-8 COTTER PIN PUNCH

481-100 GERMAN DIN-HAMMER

1157 AUTOMATIC CENTER PUNCH



FF1E5003 - 11 pcs

481-300 GERMAN DIN-HAMMER

3735-5-120 CENTRE PUNCH

3739-300 POINTED CHISEL

3740-100 FLAT CHISEL

3740-150 FLAT CHISEL

3740-200 FLAT CHISEL

3740-125 FLAT CHISEL

3733-2 DRIFT PUNCH

3733-3 DRIFT PUNCH

3733-4 DRIFT PUNCH

3733-5 DRIFT PUNCH

SOCKETS

1/3 MODULE SOCKETS AND ACCESSORIES COMPOSITION

1/4 Sockets and accessories



ERGO TOOL MANAGEMENT SYSTEM



FF1E2001 - 37 pcs

6700SM-10 SOCKET 1/4
6700SM-11 SOCKET 1/4
6700SM-12 SOCKET 1/4
6700SM-13 SOCKET 1/4
6700SM-14 SOCKET 1/4
6700SM-4 SOCKET 1/4
6700SM-5 SOCKET 1/4
6700SM-5.5 SOCKET 1/4
6700SM-6 SOCKET 1/4
6700SM-7 SOCKET 1/4
6700SM-8 SOCKET 1/4
6700SM-9 SOCKET 1/4
6700TORX-E10 SOCKET 1/4
6700TORX-E4 SOCKET 1/4
6700TORX-E5 SOCKET 1/4
6700TORX-E6 SOCKET 1/4
6700TORX-E7 SOCKET 1/4
6700TORX-E8 SOCKET 1/4

6709M-3 SOCKET 1/4
6709M-4 SOCKET 1/4
6709M-5 SOCKET 1/4
6709M-6 SOCKET 1/4
6709M-8 SOCKET 1/4
6709TORX-T10 SOCKET 1/4
6709TORX-T15 SOCKET 1/4
6709TORX-T20 SOCKET 1/4
6709TORX-T25 SOCKET 1/4
6709TORX-T27 SOCKET 1/4
6709TORX-T30 SOCKET 1/4
6709TORX-T40 SOCKET 1/4
6709TORX-T8 SOCKET 1/4
6709TORX-T9 SOCKET 1/4
6950SL RATCHET 1/4, SLIM HEAD 72T
6954 T-HANDLE 1/4
6956 NUT DRIVER 1/4
6960 EXTENSION 1/4
6966 UNIVERSAL JOINT 1/4



FF1E2002 - 45 pcs

6700SM-4 SOCKET 1/4
6700SM-4.5 SOCKET 1/4
6700SM-5 SOCKET 1/4
6700SM-5.5 SOCKET 1/4
6700SM-6 SOCKET 1/4
6700SM-7 SOCKET 1/4
6700SM-8 SOCKET 1/4
6700SM-9 SOCKET 1/4
6700SM-10 SOCKET 1/4
6700SM-11 SOCKET 1/4
6700SM-12 SOCKET 1/4
6700SM-13 SOCKET 1/4
6700SM-14 SOCKET 1/4
6709PZ-1 SOCKET 1/4
6709PZ-2 SOCKET 1/4
6709PZ-3 SOCKET 1/4
6709PH-1 SOCKET 1/4
6709PH-2 SOCKET 1/4
6709PH-3 SOCKET 1/4
6709TORX-T10 SOCKET 1/4
6709TORX-T15 SOCKET 1/4
6709TORX-T20 SOCKET 1/4
6709TORX-T25 SOCKET 1/4
6709TORX-T30 SOCKET 1/4
6709TORX-T40 SOCKET 1/4

SOCKETS

1/3 MODULE SOCKETS AND ACCESORIES COMPOSITION

1/4 Sockets and accessories



ERGO TOOL MANAGEMENT SYSTEM



FF1E2002 - 45 pcs

6709F-4.5 SOCKET 1/4

6709F-5.5 SOCKET 1/4

6709F-8 SOCKET 1/4

6709M-3 SOCKET 1/4

6709M-4 SOCKET 1/4

6709M-5 SOCKET 1/4

6709M-6 SOCKET 1/4

6709M-8 SOCKET 1/4

1998M-1.5 OFFSET KEY NICKEL 1.5 mm

1998M-2 OFFSET KEY NICKEL 2 mm

1998M-2.5 OFFSET KEY NICKEL 2.5 mm

1998M-3 OFFSET KEY NICKEL 3 mm

6950SL RATCHET 1/4, SLIM HEAD 72T

6966 UNIVERSAL JOINT 1/4

6962-W WOBBLE EXTENSION 1/4"-150 mm

6956 NUT DRIVER 1/4

6960 EXTENSION 1/4

6961 EXTENSION 1/4

7765 ADAPTOR 1/4

6954 T-HANDLE 1/4



FF1E2003 - 27 pcs

6700SM-5 SOCKET 1/4

6700SM-5.5 SOCKET 1/4

6700SM-6 SOCKET 1/4

6700SM-7 SOCKET 1/4

6700SM-8 SOCKET 1/4

6700SM-9 SOCKET 1/4

6700SM-10 SOCKET 1/4

6700SM-11 SOCKET 1/4

6700SM-12 SOCKET 1/4

6700SM-13 SOCKET 1/4

6700SM-14 SOCKET 1/4

BE-9778 SCREWDR SET HEX NICK. 9 PCS

6950SL RATCHET 1/4, SLIM HEAD 72T

6956 NUT DRIVER 1/4

6962 EXTENSION 1/4

6966 UNIVERSAL JOINT 1/4

7765 ADAPTOR 1/4

6954 T-HANDLE 1/4

1997M-12 SCREWDR OFFSET 1997M HEX 12



FF1E2004 - 48 pcs

A6700DM-5 BSOCKET 1/4, LONG

A6700DM-5.5 SOCKET 1/4, LONG

A6700DM-6 SOCKET 1/4, LONG

A6700DM-7 SOCKET 1/4, LONG

A6700DM-8 SOCKET 1/4, LONG

A6700DM-9 SOCKET 1/4, LONG

A6700DM-10 SOCKET 1/4, LONG

A6700DM-11 SOCKET 1/4, LONG

A6700DM-12 SOCKET 1/4, LONG

A6700DM-13 SOCKET 1/4, LONG

A6700DM-14 SOCKET 1/4, LONG

59S/31-1 BITS SET 31PCS PH,PZ,T,HEX,SL

808050S STUBBY RATCHETING SCREWDRIVER

6950SL RATCHET 1/4, SLIM HEAD 72T

6966 UNIVERSAL JOINT 1/4

6972H POWER SOCKET HOLDER 1/4

6962 EXTENSION 1/4

7765 ADAPTOR 1/4

SOCKETS

1/3 MODULE SOCKETS AND ACCESSORIES COMPOSITION

1/4 Sockets and accessories



ERGO TOOL MANAGEMENT SYSTEM



FF1E2005 - 17 pcs

6700SM-5.5 SOCKET 1/4

6700SM-6 SOCKET 1/4

6700SM-7 SOCKET 1/4

6700SM-8 SOCKET 1/4

6700SM-9 SOCKET 1/4

6700SM-10 SOCKET 1/4

6700SM-11 SOCKET 1/4

6700SM-12 SOCKET 1/4

6700SM-13 SOCKET 1/4

6700SM-14 SOCKET 1/4

6950RN RATCHET 1/4

6962 EXTENSION 1/4

6966 UNIVERSAL JOINT 1/4

6960 EXTENSION 1/4

6954 T-HANDLE 1/4

6956 NUT DRIVER 1/4

6972H POWER SOCKET HOLDER 1/4



FF1E2006 - 35 pcs

6700SZ-5/16 SOCKET 1/4

6700SZ-5/32 SOCKET 1/4

6700SZ-11/32 SOCKET 1/4

6700SZ-7/16 SOCKET 1/4

6700SZ-9/32 SOCKET 1/4

6700SZ-3/16 SOCKET 1/4

6700SZ-3/8 SOCKET 1/4

6700SZ-7/32 SOCKET 1/4

6700SZ-1/4 SOCKET 1/4

6700SZ-1/2 SOCKET 1/4

6700SZ-9/16 SOCKET 1/4

6709PZ-1 SOCKET 1/4

6709PZ-2 SOCKET 1/4

6709PZ-3 SOCKET 1/4

6709PH-1 SOCKET 1/4

6709PH-2 SOCKET 1/4

6709PH-3 SOCKET 1/4

6709TORX-T8 SOCKET 1/4

6709TORX-T10 SOCKET 1/4

6709TORX-T15 SOCKET 1/4

6709TORX-T20 SOCKET 1/4

6709TORX-T25 SOCKET 1/4

6709TORX-T30 SOCKET 1/4

6709F-4.5 SOCKET 1/4

6709F-6.5 SOCKET 1/4

6709F-8 SOCKET 1/4

6950RN RATCHET 1/4

6954 T-HANDLE 1/4

6972H POWER SOCKET HOLDER 1/4

6960 EXTENSION 1/4

6962 EXTENSION 1/4

6963 EXTENSION, FLEX 1/4

6966 UNIVERSAL JOINT 1/4

6956 NUT DRIVER 1/4

7765 ADAPTOR 1/4

SOCKETS

1/3 MODULE SOCKETS AND ACCESORIES COMPOSITION

- 1/4 and 3/8 sockets and accessories



ERGO TOOL MANAGEMENT SYSTEM



FF1E2007 - 24 pcs

6700SZ-9/32 SOCKET 1/4

6700SZ-3/16 SOCKET 1/4

6700SZ-3/8 SOCKET 1/4

6700SZ-1/4 SOCKET 1/4

6700SZ-7/16 SOCKET 1/4

6700SZ-7/32 SOCKET 1/4

6700SZ-1/2 SOCKET 1/4

6700SZ-11/32 SOCKET 1/4

1995Z-5/64 OFFSET SCREWDRIVER BLACK 5/64

1995Z-5/32 OFFSET SCREWDRIVER BLACK 5/32

1995Z-3/8 OFFSET SCREWDRIVER BLACK 3/8

1995Z-3/32 OFFSET SCREWDRIVER BLACK 3/32

1995Z-7/32 OFFSET SCREWDRIVER BLACK 7/32

1995Z-1/8 OFFSET SCREWDRIVER BLACK 1/8

1995Z-5/16 OFFSET SCREWDRIVER BLACK 5/16

1995Z-3/16 OFFSET SCREWDRIVER BLACK 3/16

1995Z-1/4 OFFSET SCREWDRIVER BLACK 1/4

6950RN RATCHET 1/4

6954 T-HANDLE 1/4

6972H POWER SOCKET HOLDER 1/4

6960 EXTENSION 1/4

6962 EXTENSION 1/4

6956 NUT DRIVER 1/4

6966 UNIVERSAL JOINT 1/4



FF1E2008 - 26 pcs

6700SM-5.5 SOCKET 1/4

6700SM-6 SOCKET 1/4

6700SM-7 SOCKET 1/4

6700SM-8 SOCKET 1/4

6700SM-9 SOCKET 1/4

6700SM-10 SOCKET 1/4

6700SM-11 SOCKET 1/4

6700SM-12 SOCKET 1/4

6700SM-13 SOCKET 1/4

6700SM-14 SOCKET 1/4

1995M-2 OFFSET SCREWDRIVER BLACK 2 mm

1995M-3 OFFSET SCREWDRIVER BLACK 3 mm

1995M-4 OFFSET SCREWDRIVER BLACK 4 mm

1995M-5 OFFSET SCREWDRIVER BLACK 5 mm

1995M-6 OFFSET SCREWDRIVER BLACK 6 mm

1995M-7 OFFSET SCREWDRIVER BLACK 7 mm

1995M-8 OFFSET SCREWDRIVER BLACK 8 mm

1995M-9 OFFSET SCREWDRIVER BLACK 9 mm

1995M-10 OFFSET SCREWDRIVER BLACK 10 mm

6950RN RATCHET 1/4

6960 EXTENSION 1/4

6962 EXTENSION 1/4

6966 UNIVERSAL JOINT 1/4

6954 T-HANDLE 1/4

6956 NUT DRIVER 1/4

6972H POWER SOCKET HOLDER 1/4



FF1E2101 - 24 pcs

7400SM-6 SOCKET 3/8

7400SM-7 SOCKET 3/8

7400SM-8 SOCKET 3/8

7400SM-9 SOCKET 3/8

7400SM-10 SOCKET 3/8

7400SM-11 SOCKET 3/8

7400SM-12 SOCKET 3/8

7400SM-13 SOCKET 3/8

7400SM-14 SOCKET 3/8

7400SM-15 SOCKET 3/8

7400SM-16 SOCKET 3/8

7400SM-17 SOCKET 3/8

7400SM-18 SOCKET 3/8

7400SM-19 SOCKET 3/8

7400SM-20 SOCKET 3/8

7400SM-22 SOCKET 3/8

7750SL RATCHET 3/8, SLIM HEAD 72T

7760 EXTENSION 3/8

7761 EXTENSION 3/8

7762 EXTENSION 3/8

7764 ADAPTOR 3/8

8164-1/2 ADAPTOR 3/8

7766 UNIVERSAL JOINT 3/8

7754 T-HANDLE 3/8

SOCKETS

1/3 MODULE SOCKETS AND ACCESSORIES COMPOSITION

▪ 3/8 sockets and accessories



ERGO TOOL MANAGEMENT SYSTEM



FF1E2102 - 25 pcs

7400SM-6 SOCKET 3/8
7400SM-7 SOCKET 3/8
7400SM-8 SOCKET 3/8
7400SM-9 SOCKET 3/8
7400SM-10 SOCKET 3/8
7400SM-11 SOCKET 3/8
7400SM-12 SOCKET 3/8
7400SM-13 SOCKET 3/8
7400SM-14 SOCKET 3/8
7400SM-15 SOCKET 3/8
7400SM-16 SOCKET 3/8
7400SM-17 SOCKET 3/8
7400SM-18 SOCKET 3/8
7400SM-19 SOCKET 3/8
7409M-4 SOCKET 3/8 HEX
7409M-5 SOCKET 3/8 HEX
7409M-6 SOCKET 3/8 HEX
7409M-8 SOCKET 3/8 HEX
7409M-10 SOCKET 3/8 HEX
7750SL RATCHET 3/8, SLIM HEAD 72T
7760 EXTENSION 3/8
7762 EXTENSION 3/8
7754 T-HANDLE 3/8
8164-1/2 ADAPTOR
7768 SMOOTH OPERATION U.JOINT - 3/8



FF1E2103 - 28 pcs

7400SM-7 SOCKET 3/8
7400SM-8 SOCKET 3/8
7400SM-9 SOCKET 3/8
7400SM-10 SOCKET 3/8
7400SM-11 SOCKET 3/8
7400SM-12 SOCKET 3/8
7400SM-13 SOCKET 3/8
7400SM-14 SOCKET 3/8
7400SM-15 SOCKET 3/8
7400SM-16 SOCKET 3/8
7400SM-17 SOCKET 3/8
7400SM-18 SOCKET 3/8
7400SM-19 SOCKET 3/8
7400SM-20 SOCKET 3/8
7400SM-21 SOCKET 3/8
7400SM-22 SOCKET 3/8
7400TORX-E8 SOCKET 3/8
7400TORX-E10 SOCKET 3/8
7400TORX-E12 SOCKET 3/8
7400TORX-E14 SOCKET 3/8
7400TORX-E16 SOCKET 3/8
7400TORX-E18 SOCKET 3/8
7750SL RATCHET 3/8, SLIM HEAD 72T
7760 EXTENSION 3/8
7762 EXTENSION 3/8
7768 SMOOTH OPERATION U.JOINT - 3/8
7766 UNIVERSAL JOINT 3/8
SBS705 BAHCO BREAKER BAR 3/8



FF1E2104 - 20 pcs

7400SM-6 SOCKET 3/8
7400SM-8 SOCKET 3/8
7400SM-9 SOCKET 3/8
7400SM-10 SOCKET 3/8
7400SM-11 SOCKET 3/8
7400SM-12 SOCKET 3/8
7400SM-13 SOCKET 3/8
7400SM-14 SOCKET 3/8
7400SM-15 SOCKET 3/8
7400SM-16 SOCKET 3/8
7400SM-17 SOCKET 3/8
7400SM-18 SOCKET 3/8
7400SM-19 SOCKET 3/8
7400SM-20 SOCKET 3/8
7400SM-22 SOCKET 3/8
7750RN RATCHET 3/8
7761 EXTENSION 3/8
7762 EXTENSION 3/8
7766 UNIVERSAL JOINT 3/8
7768 SMOOTH OPERATION U.JOINT-3/8

SOCKETS

1/3 MODULE SOCKETS AND ACCESORIES COMPOSITION

- 3/8 and 1/2 sockets and accessories



ERGO TOOL MANAGEMENT SYSTEM



FF1E2105 - 28 pcs

7400TORX-E8 SOCKET 3/8
7400TORX-E10 SOCKET 3/8
7400TORX-E11 SOCKET 3/8
7400TORX-E12 SOCKET 3/8
7400TORX-E14 SOCKET 3/8
7400TORX-E16 SOCKET 3/8
7400TORX-E18 SOCKET 3/8
7409TORX-T25 SOCKET 3/8
7409TORX-T25-L SOCKET 3/8 140 mm
7409TORX-T30 SOCKET 3/8
7409TORX-T30-L SOCKET 3/8 140 mm
7409TORX-T40 SOCKET 3/8
7409TORX-T40-L SOCKET 3/8 140 mm
7409TORX-T45 SOCKET 3/8
7409TORX-T45-L SOCKET 3/8 140 mm
7409TORX-T50 SOCKET 3/8
7409TORX-T50-L SOCKET 3/8 140 mm
7409M-4 SOCKET 3/8 HEX
7409M-5 SOCKET 3/8 HEX
7409M-6 SOCKET 3/8 HEX
7409M-8 SOCKET 3/8 HEX
7409M-10 SOCKET 3/8 HEX
7409F-6.5 SOCKET 3/8 FLAT TIP
7409F-8 SOCKET 3/8 FLAT TIP
7409F-10 SOCKET 3/8 FLAT TIP
7409PH-1 SOCKET 3/8 PHILLIPS
7409PH-2 SOCKET 3/8 PHILLIPS
7409PH-3 SOCKET 3/8 PHILLIPS



FF1E2201 - 21 pcs

7800SM-10 SOCKET 1/2
7800SM-11 SOCKET 1/2
7800SM-12 SOCKET 1/2
7800SM-13 SOCKET 1/2
7800SM-14 SOCKET 1/2
7800SM-15 SOCKET 1/2
7800SM-17 SOCKET 1/2
7800SM-18 SOCKET 1/2
7800SM-19 SOCKET 1/2
7800SM-20 SOCKET 1/2
7800SM-21 SOCKET 1/2
7800SM-22 SOCKET 1/2
7800SM-24 SOCKET 1/2
7800SM-27 SOCKET 1/2
7805SM-16 SOCKET DEEP 1/2
7805SM-21 SOCKET DEEP 1/2
8150SL RATCHET 1/2, SLIM HEAD 72T
8160-1/2 EXTENSION 1/2
8162-1/2 EXTENSION 1/2
8166-1/2 UNIVERSAL JOINT 1/2
8165-1/2 ADAPTOR 1/2



FF1E2202 - 21 pcs

7800SM-8 SOCKET 1/2
7800SM-9 SOCKET 1/2
7800SM-10 SOCKET 1/2
7800SM-11 SOCKET 1/2
7800SM-12 SOCKET 1/2
7800SM-13 SOCKET 1/2
7800SM-14 SOCKET 1/2
7800SM-15 SOCKET 1/2
7800SM-16 SOCKET 1/2
7800SM-17 SOCKET 1/2
7800SM-18 SOCKET 1/2
7800SM-19 SOCKET 1/2
7800SM-20 SOCKET 1/2
7800SM-21 SOCKET 1/2
7800SM-23 SOCKET 1/2
7800SM-24 SOCKET 1/2
7800SM-27 SOCKET 1/2
8150-1/2 RATCHET 1/2
8160-1/2 EXTENSION 1/2
8162-1/2 EXTENSION 1/2
8166-1/2 UNIVERSAL JOINT 1/2

SOCKETS

1/3 MODULE SOCKETS AND ACCESSORIES COMPOSITION

1/2 sockets and accessories



ERGO TOOL MANAGEMENT SYSTEM



FF1E2203 - 22 pcs

7800SM-8 SOCKET 1/2
 7800SM-9 SOCKET 1/2
 7800SM-10 SOCKET 1/2
 7800SM-11 SOCKET 1/2
 7800SM-12 SOCKET 1/2
 7800SM-13 SOCKET 1/2
 7800SM-14 SOCKET 1/2
 7800SM-15 SOCKET 1/2
 7800SM-16 SOCKET 1/2
 7800SM-17 SOCKET 1/2
 7800SM-18 SOCKET 1/2
 7800SM-19 SOCKET 1/2
 7800SM-21 SOCKET 1/2
 7800SM-22 SOCKET 1/2
 7800SM-24 SOCKET 1/2
 7800SM-27 SOCKET 1/2
 7800SM-30 SOCKET 1/2
 7800SM-32 SOCKET 1/2
 8150RN-1/2 RATCHET ROUND 1/2
 8160-1/2 EXTENSION 1/2
 8162-1/2 EXTENSION 1/2
 8166-1/2 UNIVERSAL JOINT 1/2



FF1E2204 - 15 pcs

7800DZ-1/2 SOCKET 1/2
 7800DZ-3/4 SOCKET 1/2
 7800DZ-19/32 SOCKET 1/2
 7800DZ-7/8 SOCKET 1/2
 7800DZ-7/16 SOCKET 1/2
 7800DZ-11/16 SOCKET 1/2
 7800DZ-9/16 SOCKET 1/2
 7800DZ-13/16 SOCKET 1/2
 7800DZ-3/8 SOCKET 1/2
 7800DZ-5/8 SOCKET 1/2
 7800DZ-15/16 SOCKET 1/2
 8150RN-1/2 RATCHET 1/2
 8160-1/2 EXTENSION 1/2
 8162-1/2 EXTENSION 1/2
 8166-1/2 UNIVERSAL JOINT 1/2



FF1E2205 - 28 pcs

7800DM-10 SOCKET 1/2
 7800DM-11 SOCKET 1/2
 7800DM-12 SOCKET 1/2
 7800DM-13 SOCKET 1/2
 7800DM-14 SOCKET 1/2
 7800DM-15 SOCKET 1/2
 7800DM-16 SOCKET 1/2
 7800DM-17 SOCKET 1/2
 7800DM-18 SOCKET 1/2
 7800DM-19 SOCKET 1/2
 7800DM-20 SOCKET 1/2
 7800DM-21 SOCKET 1/2
 7800DM-22 SOCKET 1/2
 7800DM-23 SOCKET 1/2
 7800DM-24 SOCKET 1/2
 7800DM-25 SOCKET 1/2
 7800DM-26 SOCKET 1/2
 7800DM-27 SOCKET 1/2
 7800DM-28 SOCKET 1/2
 7800DM-30 SOCKET 1/2
 7800DM-32 SOCKET 1/2
 7809M-6 SOCKET 1/2
 7809M-7 SOCKET 1/2
 7809M-8 SOCKET 1/2
 7809M-9 SOCKET 1/2
 7809M-10 SOCKET 1/2
 7809M-12 SOCKET 1/2
 7809M-14 SOCKET 1/2

■ SOCKETS

1/3 MODULE SOCKETS AND ACCESORIES COMPOSITION

- 1/2 sockets and accessories



ERGO TOOL MANAGEMENT SYSTEM



FF1E2206 - 27 pcs

7800SM-10 SOCKET 1/2
7800SM-11 SOCKET 1/2
7800SM-12 SOCKET 1/2
7800SM-13 SOCKET 1/2
7800SM-14 SOCKET 1/2
7800SM-15 SOCKET 1/2
7800SM-16 SOCKET 1/2
7800SM-17 SOCKET 1/2
7800SM-18 SOCKET 1/2
7800SM-19 SOCKET 1/2
7800SM-20 SOCKET 1/2
7800SM-21 SOCKET 1/2
7800SM-22 SOCKET 1/2
7800SM-23 SOCKET 1/2
7800SM-24 SOCKET 1/2
7800SM-25 SOCKET 1/2
7800SM-26 SOCKET 1/2
7800SM-27 SOCKET 1/2
7800SM-28 SOCKET 1/2
7800SM-30 SOCKET 1/2
7800SM-32 SOCKET 1/2
7809XZN-8 SOCKET 1/2
7809XZN-10 SOCKET 1/2
7809PZ-2 SOCKET 1/2
7809PZ-3 SOCKET 1/2
7809F-8 SOCKET 1/2
7809F-10 SOCKET 1/2



FF1E2207 - 25 pcs

7809TORX-T20 SOCKET 1/2
7809TORX-T25 SOCKET 1/2
7809TORX-T27 SOCKET 1/2
7809TORX-T30 SOCKET 1/2
7809TORX-T40 SOCKET 1/2
7809TORX-T45 SOCKET 1/2
7809TORX-T50 SOCKET 1/2
7809TORX-T55 SOCKET 1/2
7809TORX-T60 SOCKET 1/2
7800TORX-E8 SOCKET 1/2
7800TORX-E10 SOCKET 1/2
7800TORX-E12 SOCKET 1/2
7800TORX-E14 SOCKET 1/2
7800TORX-E16 SOCKET 1/2
7800TORX-E18 SOCKET 1/2
7800TORX-E20 SOCKET 1/2
7800TORX-E24 SOCKET 1/2
BE-9675 SCREWDRIVER SET TORX BALL 8 PCS



FF1E2208 - 12 pcs

7809M-6 SOCKET 1/2
7809M-7 SOCKET 1/2
7809M-8 SOCKET 1/2
7809M-9 SOCKET 1/2
7809M-10 SOCKET 1/2
7809M-12 SOCKET 1/2
7809M-14 SOCKET 1/2
7809M-17 SOCKET 1/2
7809M-5-180 SOCKET 1/2
7809M-6-140 SOCKET 1/2
7809M-8-120 SOCKET 1/2
7809M-10-140 SOCKET 1/2

SOCKETS

1/3 MODULE SOCKETS AND ACCESSORIES COMPOSITION

- 1/2 and Mix sockets and accessories



ERGO TOOL MANAGEMENT SYSTEM



FF1E2209 - 20 pcs

7809M-5 SOCKET 1/2

7809M-6 SOCKET 1/2

7809M-7 SOCKET 1/2

7809M-8 SOCKET 1/2

7809M-10 SOCKET 1/2

7809M-12 SOCKET 1/2

7809M-14 SOCKET 1/2

7809M-17 SOCKET 1/2

7809TORX-T27 SOCKET 1/2

7809TORX-T25 SOCKET 1/2

7809TORX-T30 SOCKET 1/2

7809TORX-T40 SOCKET 1/2

7809TORX-T45 SOCKET 1/2

7809TORX-T50 SOCKET 1/2

7809TORX-T55 SOCKET 1/2

7809TORX-T60 SOCKET 1/2

7809XZN-6 SOCKET 1/2

7809XZN-8 SOCKET 1/2

7809XZN-10 SOCKET 1/2

7809XZN-12 SOCKET 1/2



FF1E2210 - 14 pcs

7809M-5 SOCKET 1/2

7809M-6 SOCKET 1/2

7809M-7 SOCKET 1/2

7809M-8 SOCKET 1/2

7809M-10 SOCKET 1/2

7809M-12 SOCKET 1/2

7809M-14 SOCKET 1/2

7809M-17 SOCKET 1/2

7809M-19 SOCKET 1/2

BE-7606 NUT DRIVER ERGO

BWSS12P319 1/2-19 mm WHEEL IMP SOCKET

BWSS12P321 1/2-21 mm WHEEL IMP SOCKET

BWSS12P317 1/2-17 mm WHEEL IMP SOCKET

BE-7607 NUT DRIVER ERGO

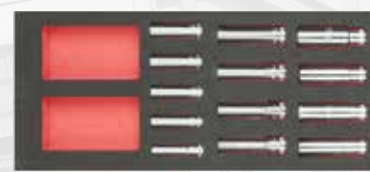

FF1E2501 - 13 pcs

A7402DM-10 SOCKET 3/8, LONG

A7402DM-11 SOCKET 3/8, LONG

A7402DM-12 SOCKET 3/8, LONG

A7402DM-13 SOCKET 3/8, LONG

A7402DM-14 SOCKET 3/8, LONG

7805SM-12 SOCKET DEEP 1/2

7805SM-13 SOCKET DEEP 1/2

7805SM-14 SOCKET DEEP 1/2

7805SM-15 SOCKET DEEP 1/2

7805SM-16 SOCKET DEEP 1/2

7805SM-17 SOCKET DEEP 1/2

7805SM-18 SOCKET DEEP 1/2

7805SM-19 SOCKET DEEP 1/2

■ SCREWDRIVERS

1/3 MODULE SCREWDRIVERS COMPOSITION

- Slotted, Phillips and Pozidriv Screwdrivers



ERGO TOOL MANAGEMENT SYSTEM



FF1E1001 - 7 pcs

BE-8030 SCREW.DR ERGO 0,6 X 3,5 X 75

BE-8040 SCREW.DR ERGO 0,8 X 4,0 X 100

BE-8242 SCREW.DR ERGO 1,0 X 5,5 X 150

BE-8252 SCREW.DR ERGO 1,2 X 6,5 X 150

BE-8610 SCREW.DR ERGO PH1 X 75

BE-8620 SCREW.DR ERGO PH2 X 100

BE-8623 SCREW.DR ERGO PH3 X 150



FF1E1002 - 7 pcs

BE-8242 SCREW.DR ERGO 1,0 X 5,5 X 150

BE-8257 SCREW.DR ERGO 1,2 X 8,0 X 175

BE-8040 SCREW.DR ERGO 0,8 X 4,0 X 100

BE-8255 SCREW.DR ERGO 1,2 X 6,5 X 150

BE-8030 SCREW.DR ERGO 0,6 X 3,5 X 75

BE-8611 SCREW.DR ERGO PH1 X 75

BE-8621 SCREW.DR ERGO PH2 X 100



FF1E1003 - 6 pcs

BE-8240 SCREW.DR ERGO 0,8 X 4,0 X 175

BE-8150 SCREW.DR ERGO 1,0 X 5,5 X 100

BE-8255 SCREW.DR ERGO 1,2 X 6,5 X 150

BE-8256 SCREW.DR ERGO 1,2 X 8,0 X 150

BE-8810 SCREW.DR ERGO PZ1 X 75

BE-8820 SCREW.DR ERGO PZ2 X 100



FF1E1004 - 8 pcs

BE-8340 SCREW.DR ERGO 0,8 X 4 X 25

BE-8350 SCREW.DR ERGO 1 X 5,5 X 25

BE-8600 SCREW.DR ERGO PH0 X 60

BE-8610 SCREW.DR ERGO PH1 X 75

BE-8800 SCREW.DR ERGO PZ0 X 60

BE-8811 SCREW.DR ERGO PZ1 X 75

BE-8820L SCREW.DR ERGO PZ2 X 200

BE-8821 SCREW.DR ERGO PZ2 X 100



FF1E1005 - 7 pcs

BE-8210 SCREW.DR ERGO 0,4 X 2,5 X 75

BE-8010 SCREW.DR ERGO 0,4 X 2,5 X 60

BE-8800 SCREW.DR ERGO PZ0 X 60

BE-8811 SCREW.DR ERGO PZ1 X 75

BE-8821 SCREW.DR ERGO PZ2 X 100

BE-8830 SCREW.DR ERGO PZ3 X 150

BE-8600 SCREW.DR ERGO PH0 X 60



FF1E1006 - 6 pcs

BE-8210 SCREW.DR ERGO 0,4 X 2,5 X 75

BE-8610 SCREW.DR ERGO PH1 X 75

BE-8620 SCREW.DR ERGO PH2 X 100

BE-8630 SCREW.DR ERGO PH3 X 150

BE-8811 SCREW.DR ERGO PZ1 X 75

BE-8820 SCREW.DR ERGO PZ2 X 100

■ SCREWDRIVERS

1/3 MODULE SCREWDRIVERS COMPOSITION

- Standard Torx Screwdrivers
- Insulated Slotted, PH and PZ Screwdrivers



ERGO TOOL MANAGEMENT SYSTEM



FF1E1007 - 6 pcs

BE-8910 SCREW.DR ERGO TX 10 X 65

BE-8915 SCREW.DR ERGO TX 15 X 70

BE-8920 SCREW.DR ERGO TX 20 X 80

BE-8925 SCREW.DR ERGO TX 25 X 80

BE-8930 SCREW.DR ERGO TX 30 X 100

BE-8940 SCREW.DR ERGO TX 40 X 130

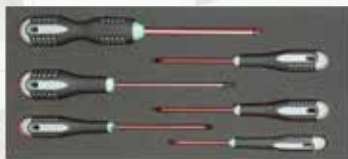

FF1E1008 - 6 pcs

BE-7910 SCREW.DR ERGO BTX 10 X 65

BE-7915 SCREW.DR ERGO BTX 15 X 70

BE-7920 SCREW.DR ERGO BTX 20 X 80

BE-7925 SCREW.DR ERGO BTX 25 X 80

BE-7930 SCREW.DR ERGO BTX 30 X 100

BE-7940 SCREW.DR ERGO BTX 40 X 130

BE-8621 SCREW.DR ERGO PH2 X 100



FF1E1009 - 6 pcs

BE-8908 SCREW.DR ERGO TX 8 X 60

BE-8910 SCREW.DR ERGO TX 10 X 65

BE-8915 SCREW.DR ERGO TX 15 X 70

BE-8920 SCREW.DR ERGO TX 20 X 80

BE-8925 SCREW.DR ERGO TX 25 X 80

BE-8930 SCREW.DR ERGO TX 30 X 100



FF1E1010 - 6 pcs

BE-8010S SCREW.DR ERGO IEC 0,4 X 2,5 X 75

BE-8230S SCREW.DR ERGO IEC 0,6 X 3,5 X 100

BE-8050S SCREW.DR ERGO IEC 1,0 X 5,5 X 125

BE-8255S SCREW.DR ERGO IEC 1,2 X 6,5 X 150

BE-8610S SCREW.DR ERGO IEC PH1 X 75

BE-8620S SCREW.DR ERGO IEC PH2 X 100



FF1E1011 - 6 pcs

BE-8040S SCREW.DR ERGO IEC 0,8 X 4,0 X 100

BE-8050S SCREW.DR ERGO IEC 1,0 X 5,5 X 125

BE-8255S SCREW.DR ERGO IEC 1,2 X 6,5 X 150

BE-8065S SCREW.DR ERGO IEC 1,2 X 8,0 X 175

BE-8610S SCREW.DR ERGO IEC PH1 X 75

BE-8620S SCREW.DR ERGO IEC PH2 X 100

PLIERS

1/3 MODULE PLIERS COMPOSITION

- Mix pliers
- Circlip Pliers



ERGO TOOL MANAGEMENT SYSTEM



FF1E4001 - 4 pcs

2628 G-180IP COMB PLIER 180 mm

8231 IP SLIP JOINT PLIER

2430 G-200 IP SNIPE NOSE CUTTING 200 mm

2101G-160IP SIDE CUTTER 160 mm

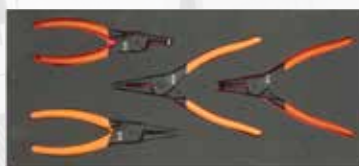

FF1E4002 - 4 pcs

2900-180 CIRCLIP PLIER 180 mm

2890-180 CIRCLIP PLIER 180 mm

2990-180 CIRCLIP PLIER 180 mm

2800-180 CIRCLIP PLIER 180 mm

■ WRENCHES

1/3 MODULE WRENCHES COMPOSITION

- Double Open end metric and Imperial Wrenches
- Ratcheting Wrenches



ERGO TOOL MANAGEMENT SYSTEM



FF1E3001 - 9 pcs

6M-6-7 OPEN END WRENCH

6M-8-9 OPEN END WRENCH

6M-10-11 OPEN END WRENCH

6M-12-13 OPEN END WRENCH

6M-14-15 OPEN END WRENCH

6M-16-17 OPEN END WRENCH

6M-18-19 OPEN END WRENCH

6M-21-23 OPEN END WRENCH

6M-22-24 OPEN END WRENCH



FF1E3002 - 3 pcs

6M-25-28 OPEN END WRENCH

6M-27-29 OPEN END WRENCH

6M-30-32 OPEN END WRENCH



FF1E3003 - 9 pcs

6Z-1/2-9/16 OPEN END WRENCH

6Z-15/16-1 OPEN END WRENCH

6Z-5/16-11/32 OPEN END WRENCH

6Z-5/8-3/4 OPEN END WRENCH

6Z-3/8-7/16 OPEN END WRENCH

6Z-25/32-13/16 OPEN END WRENCH

6Z-19/32-11/16 OPEN END WRENCH

6Z-1/4-5/16 OPEN END WRENCH

6Z-3/4-7/8 OPEN END WRENCH



FF1E3004 - 10 pcs

1RM-8 RATCHET WRENCH

1RM-9 RATCHET WRENCH

1RM-10 RATCHET WRENCH

1RM-11 RATCHET WRENCH

1RM-12 RATCHET WRENCH

1RM-13 RATCHET WRENCH

1RM-14 RATCHET WRENCH

1RM-15 RATCHET WRENCH

1RM-16 RATCHET WRENCH

1RM-17 RATCHET WRENCH



FF1E3005 - 40 pcs

41RM-8 RATCHET WRENCH LOCKING FLEX HEAD

41RM-10 RATCHET WRENCH LOCKING FLEX HEAD

41RM-12 RATCHET WRENCH LOCKING FLEX HEAD

41RM-13 RATCHET WRENCH LOCKING FLEX HEAD

41RM-14 RATCHET WRENCH LOCKING FLEX HEAD

41RM-17 RATCHET WRENCH LOCKING FLEX HEAD

41RM-19 RATCHET WRENCH LOCKING FLEX HEAD

8166-1/2 UNIVERSAL JOINT

6966 UNIVERSAL JOINT

59S/31-1 BITS SET 31PCS PH, PZ, T, HEX, SL

■ WRENCHES

1/3 MODULE WRENCHES COMPOSITION

- Double Ring End Wrenches
- Ratcheting Wrenches
- Tubular Box Wrenches



ERGO TOOL MANAGEMENT SYSTEM



FF1E3006 - 8 pcs

1320RM-6-7 RATCHET WRENCH DOUBLE FLAT

1320RM-8-9 RATCHET WRENCH DOUBLE FLAT

1320RM-10-11 RATCHET WRENCH DOUBLE FLAT

1320RM-12-13 RATCHET WRENCH DOUBLE FLAT

1320RM-14-15 RATCHET WRENCH DOUBLE FLAT

1320RM-16-17 RATCHET WRENCH DOUBLE FLAT

1320RM-18-19 RATCHET WRENCH DOUBLE FLAT

1320RM-22-24 RATCHET WRENCH DOUBLE FLAT



FF1E3007 - 7 pcs

2M-6-7 RING WRENCH

2M-8-9 RING WRENCH

2M-10-11 RING WRENCH

2M-12-13 RING WRENCH

2M-14-15 RING WRENCH

2M-16-17 RING WRENCH

2M-18-19 RING WRENCH



FF1E3008 - 9 pcs

27M-8-9 TUBULAR BOX SPANNER 8-9 mm

27M-10-11 TUBULAR BOX SPANNER 10-11 mm

27M-12-13 TUBULAR BOX SPANNER 12-13 mm

27M-14-15 TUBULAR BOX SPANNER 14-15 mm

27M-16-17 TUBULAR BOX SPANNER 16-17 mm

27M-18-19 TUBULAR BOX SPANNER 18-19 mm

27M-20-22 TUBULAR BOX SPANNER 20-22 mm

27M-21-23 TUBULAR BOX SPANNER 21-23 mm

27M-24-27 TUBULAR BOX SPANNER 24-27 mm



MIX AND WRENCHES

2/3 MODULE MIX AND WRENCHES COMPOSITION

- Double Ring end Wrenches
- Flex Head Wrenches
- Open Ring Wrenches



ERGO TOOL MANAGEMENT SYSTEM



FF1F5001 - 10 pcs

1-100-08-1-2 8" HAND, WITH HANDLE, CUT 1

1-160-08-1-2 8" SQUARE, WITH HANDLE, CUT 1

1-170-08-1-2 8" 3 SQUARE, WITH HANDLE, CUT 1

1-210-08-1-2 8" 1/2 ROUND, WITH HANDLE, CUT 1

1-230-08-1-2 8" ROUND, WITH HANDLE, CUT 1

2430 G-200 IP SNIPER NOSE CUTTING 200 mm

2628G-200IP COMB PLIER 200 mm

7224 SLIP JOINT PLIER 250 mm

2101G-160IP SIDE CUTTER 160 mm

MTB-3-16 3M TAPE MEASURE 16 mm



FF1F3007 - 10 pcs

2M-6-7 RING WRENCH

2M-8-9 RING WRENCH

2M-10-11 RING WRENCH

2M-12-13 RING WRENCH

2M-14-15 RING WRENCH

2M-16-18 RING WRENCH

2M-17-19 RING WRENCH

2M-21-23 RING WRENCH

2M-24-27 RING WRENCH

2M-30-32 RING WRENCH



FF1F3008 - 9 pcs

4040M-6-7 FLEX. HEAD WRENCH

4040M-8-9 FLEX. HEAD WRENCH

4040M-10-11 FLEX. HEAD WRENCH

4040M-12-13 FLEX. HEAD WRENCH

4040M-14-15 FLEX. HEAD WRENCH

4040M-16-17 FLEX. HEAD WRENCH

4040M-18-19 FLEX. HEAD WRENCH

4040M-20-22 FLEX. HEAD WRENCH

4040M-21-23 FLEX. HEAD WRENCH



FF1F3009 - 8 pcs

1949M-8-9 OPEN RING WRENCH

1949M-10-11 OPEN RING WRENCH

1949M-12-13 OPEN RING WRENCH

1949M-14-15 OPEN RING WRENCH

1949M-17-19 OPEN RING WRENCH

1949M-19-22 OPEN RING WRENCH

1949M-24-27 OPEN RING WRENCH

1949M-30-32 OPEN RING WRENCH

PLIERS

2/3 MODULE PLIERS COMPOSITION

- Pliers Mix Including:
 - Side Cutting Pliers
 - Slip Joint Pliers
 - Circlip Pliers
 - Snipe Nose Pliers
 - Combination Pliers



ERGO TOOL MANAGEMENT SYSTEM



FF1F4001 - 8 pcs

2430 G-160 IP SNIPE NOSE CUTTING 160 mm

2421 G-180 IP FLAT NOSE PL 180 mm

2101G-160IP SIDE CUTTER 160 mm

2628 G-200 COMBINATION PLIER ERGO 200 mm

8224 IP SLIP JOINT PLIER

9029 ADJUSTABLE WRENCH

2951-140 CURVED JAWS CLAMP 140 mm

2951-300 GRIP WITH WIRE CUTTER 300 mm



FF1F4002 - 8 pcs

2928-160 CIRCLIP PLIER 160 mm

2951-250 GRIP WITH WIRE CUTTER 250 mm

SC127 ELECTRICIAN'S SCISSORS 5" 130 mm

2101G-160IP SIDE CUTTER 160 mm

8224 IP SLIP JOINT PLIER 250 mm

2430 G-160 IP SNIPE NOSE CUTTING 160 mm

2339 DIP FENCING PLIER 2339 DIP

2628 G-180IP COMB PLIER 180 mm



FF1F4003 - 4 pcs

2101G-160IP SIDE CUTTER 160 mm

8224 IP SLIP JOINT PLIER 250 mm

2951-180 GRIP WITH WIRE CUTTER 180 mm

2430 G-200 IP SNIPE NOSE CUTTING 200 mm

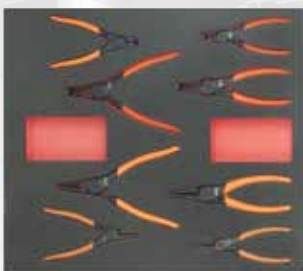

FF1F4004 - 8 pcs

2800-140 CIRCLIP PLIER 130 mm

2800-180 CIRCLIP PLIER 180 mm

2890-140 CIRCLIP PLIER 140 mm

2890-180 CIRCLIP PLIER 180 mm

2900-140 EXT.RING PLIER 140 mm

2900-180 CIRCLIP PLIER 180 mm

2990-140 CIRCLIP PLIER 140 mm

2990-180 CIRCLIP PLIER 180 mm



FF1F4005 - 5 pcs

2101S-160 SIDE CUTTER 160 mm

2430 S-200 LONG NOSE PLIER 200 mm

2427 S-200 LONG NOSE PLIER 200 mm

8224 IP SLIP JOINT PLIER 250 mm

2628 S-180 COMB PLIER 180 mm

■ SCREWDRIVERS

2/3 MODULE SCREWDRIVERS COMPOSITION

- Slotted Screwdrivers
- PH Screwdrivers



ERGO TOOL MANAGEMENT SYSTEM



FF1F1001 - 8 pcs

BE-8210 SCREW.DR ERGO 0,4 X 2,5 X 75

BE-8030 SCREW.DR ERGO 0,6 X 3,5 X 75

BE-8040 SCREW.DR ERGO 0,8 X 4,0 X 100

BE-8242 SCREW.DR ERGO 1,0 X 5,5 X 150

BE-8250L SCREW.DR ERGO 1 X 5,5 X 200

BE-8255 SCREW.DR ERGO 1,2 X 6,5 X 150

BE-8257 SCREW.DR ERGO 1,2 X 8,0 X 175



FF1F1002 - 11 pcs

BE-8020 SCREW.DR ERGO 0,5 X 3,0 X 60

BE-8330 SCREW.DR ERGO 0,6 X 3,5 X 25

BE-8040 SCREW.DR ERGO 0,8 X 4,0 X 100

BE-8242 SCREW.DR ERGO 1,0 X 5,5 X 150

BE-8252 SCREW.DR ERGO 1,2 X 6,5 X 150

BE-8256 SCREW.DR ERGO 1,2 X 8,0 X 150

BE-8258 SCREW.DR ERGO 1,6 X 10,0 X 200

BE-8610 SCREW.DR ERGO PH1 X 75

BE-8602 SCREW.DR ERGO PH2 X 25

BE-8620 SCREW.DR ERGO PH2 X 100

BE-8623 SCREW.DR ERGO PH3 X 150



FF1F1003 - 11 pcs

BE-8030 SCREW.DR ERGO 0,6 X 3,5 X 75

BE-8242 SCREW.DR ERGO 1,0 X 5,5 X 150

BE-8155 SCREW.DR ERGO 1,2 X 6,5 X 125

BE-8252 SCREW.DR ERGO 1,2 X 6,5 X 150

BE-8870 SCREW.DR ERGO 1,6 X 10,0 X 175

BE-8600 SCREW.DR ERGO PH0 X 60

BE-8610 SCREW.DR ERGO PH1 X 75

BE-8620 SCREW.DR ERGO PH2 X 100

BE-8623 SCREW.DR ERGO PH3 X 150

BE-8624 SCREW.DR ERGO PH4 X 200

808050TS STUBBY THANDLE RATCHETING SCRE

■ SCREWDRIVERS

2/3 MODULE SCREWDRIVERS COMPOSITION

- Torx Screwdrivers
- Insulated Slotted and PH Screwdrivers
- T Handle



ERGO TOOL MANAGEMENT SYSTEM



FF1F1004 - 10 pc

BE-8904 SCREW.DR ERGO TX 4 X 75

BE-8907 SCREW.DR ERGO TX 7 X 55

BE-8908 SCREW.DR ERGO TX 8 X 60

BE-7910 SCREW.DR ERGO BTX 10 X 65

BE-7915 SCREW.DR ERGO BTX 15 X 70

BE-7920 SCREW.DR ERGO BTX 20 X 80

BE-7925 SCREW.DR ERGO BTX 25 X 80

BE-7927 SCREW.DR ERGO BTX 27 X 100

BE-7930 SCREW.DR ERGO BTX 30 X 100

BE-7940 SCREW.DR ERGO BTX 40 X 130



FF1F1005 - 12 pcs

BE-8908 SCREW.DR ERGO TX 8 X 60

BE-8909 SCREW.DR ERGO TX 9 X 60

BE-8910 SCREW.DR ERGO TX 10 X 65

BE-8915 SCREW.DR ERGO TX 15 X 70

BE-8920 SCREW.DR ERGO TX 20 X 80

BE-8925 SCREW.DR ERGO TX 25 X 80

BE-8927 SCREW.DR ERGO TX 27 X 100

BE-8930 SCREW.DR ERGO TX 30 X 100

59S/31-3 BITS SET 31PCS PH,PZ,TR

K6650-1/4 ADAPTOR 1/4" 50MM 1/4" W/PIN

808050S STUBBY RATCHETING SCREWDRIVER

808050 RATCHETING BIT SCREWDRIVER



FF1F1006 - 8 pcs

BE-8230S SCREW.DR ERGO IEC 0,6 X 3,5 X 100

BE-8040S SCREW.DR ERGO IEC 0,8 X 4,0 X 100

BE-8050S SCREW.DR ERGO IEC 1,0 X 5,5 X 125

BE-8255S SCREW.DR ERGO IEC 1,2 X 6,5 X 150

BE-8810S SCREW.DR ERGO IEC PZ1 X 75

BE-8820S SCREW.DR ERGO IEC PZ2 X 100

BE-8610S SCREW.DR ERGO IEC PH1 X 75

BE-8620S SCREW.DR ERGO IEC PH2 X 100



FF1F1007 - 7 pcs

901T-010-100 TORX T-HANDLE 10 X 100

901T-015-150 TORX T-HANDLE 15 X 150

901T-020-150 TORX T-HANDLE 20 X 150

901T-025-150 TORX T-HANDLE 25 X 150

901T-027-150 TORX T-HANDLE 27 X 150

901T-030-200 TORX T-HANDLE 30 X 200

901T-040-200 TORX T-HANDLE 40 X 200

SOCKETS

2/3 MODULE SOCKETS AND ACCESSORIES COMPOSITION

- 1/4 and 3/8 sockets and accessories



ERGO TOOL MANAGEMENT SYSTEM



FF1F2001 - 44 pcs

A6800DM-4 SOCKET 1/4, LONG

A6800DM-5 SOCKET 1/4, LONG

A6800DM-5.5 SOCKET 1/4, LONG

A6800DM-6 SOCKET 1/4, LONG

A6800DM-7 SOCKET 1/4, LONG

A6800DM-8 SOCKET 1/4, LONG

A6800DM-9 SOCKET 1/4, LONG

A6800DM-10 SOCKET 1/4, LONG

A6800DM-11 SOCKET 1/4, LONG

A6800DM-12 SOCKET 1/4, LONG

A6800DM-13 SOCKET 1/4, LONG

6700SM-5 SOCKET 1/4

6700SM-5.5 SOCKET 1/4

6700SM-6 SOCKET 1/4

6700SM-7 SOCKET 1/4

6700SM-8 SOCKET 1/4

6700SM-9 SOCKET 1/4

6700SM-10 SOCKET 1/4

6700SM-11 SOCKET 1/4

6700SM-12 SOCKET 1/4

6700SM-13 SOCKET 1/4

6700SM-14 SOCKET 1/4

6709PH-1 SOCKET 1/4

6709PH-2 SOCKET 1/4

6709PH-3 SOCKET 1/4

6709PZ-1 SOCKET 1/4

6709PZ-2 SOCKET 1/4

6709M-3 SOCKET 1/4

6709M-4 SOCKET 1/4

6709M-5 SOCKET 1/4

6709M-6 SOCKET 1/4

6709M-8 SOCKET 1/4

6709F-4.5 SOCKET 1/4

6709F-5.5 SOCKET 1/4

6709F-8 SOCKET 1/4

BE-9778 SCREWDRIVER SET HEX NICK. 9 PCS

6950SL RATCHET 1/4, SLIM HEAD 72T

7765 ADAPTOR 1/4

6954 T-HANDLE 1/4

6962 EXTENSION 1/4

6966 UNIVERSAL JOINT 1/4

6972H POWER SOCKET HOLDER 1/4

6956 NUT DRIVER

1997M-12 SCREWDR OFFSET HEX 12



FF1F2101 - 36 pcs

7400SM-7 SOCKET 3/8

7400SM-8 SOCKET 3/8

7400SM-9 SOCKET 3/8

7400SM-10 SOCKET 3/8

7400SM-11 SOCKET 3/8

7400SM-12 SOCKET 3/8

7400SM-13 SOCKET 3/8

7400SM-14 SOCKET 3/8

7400SM-15 SOCKET 3/8

7400SM-16 SOCKET 3/8

7400SM-17 SOCKET 3/8

7400SM-18 SOCKET 3/8

7400SM-19 SOCKET 3/8

7400SM-20 SOCKET 3/8

7400SM-21 SOCKET 3/8

7400SM-22 SOCKET 3/8

7409M-4 SOCKET DRIVER 3/8 HEX

7409M-6 SOCKET DRIVER 3/8 HEX

SOCKETS

2/3 MODULE SOCKETS AND ACCESSORIES COMPOSITION

- 3/8 and 1/2 sockets and accessories



ERGO TOOL MANAGEMENT SYSTEM



FF1F2101 - 36 pcs

7409M-8 SOCKET DRIVER 3/8 HEX
 7409M-10 SOCKET DRIVER 3/8 HEX
 A7402DM-13 SOCKET 3/8, LONG
 A7402DM-11 SOCKET 3/8, LONG
 A7402DM-10 SOCKET 3/8, LONG
 A7402DM-12 SOCKET 3/8, LONG
 A7410DZ-5/16 SWIVEL SOCKET 3/8, LONG
 A7410DZ-7/16 SWIVEL SOCKET 3/8, LONG
 A7410DZ-9/16 SWIVEL SOCKETS 3/8, LONG
 A7410DZ-3/8 SWIVEL SOCKET 3/8, LONG
 A7410DZ-5/8 SWIVEL SOCKET 3/8, LONG
 7750SL RATCHET 3/8, SLIM HEAD 72T
 7762 EXTENSION 3/8
 8164-1/2 ADAPTOR 3/8
 7754 T-HANDLE 3/8
 7766 UNIVERSAL JOINT 3/8
 7764 ADAPTOR 3/8
 7757 NUT DRIVER 3/8



FF1F2201 -35 pcs

7800SM-10 SOCKET 1/2
 7800SM-12 SOCKET 1/2
 7800SM-13 SOCKET 1/2
 7800SM-17 SOCKET 1/2
 7800SM-18 SOCKET 1/2
 7800SM-19 SOCKET 1/2
 7800SM-20 SOCKET 1/2"
 7800SM-21 SOCKET 1/2
 7800SM-22 SOCKET 1/2
 7800SM-24 SOCKET 1/2
 7800SM-27 SOCKET 1/2
 7800SM-30 SOCKET 1/2
 7800SM-32 SOCKET 1/2
 7800DM-10 SOCKET 1/2
 7800DM-11 SOCKET 1/2
 7800DM-12 SOCKET 1/2
 7800DM-13 SOCKET 1/2

7800DM-14 SOCKET 1/2

7800DM-15 SOCKET 1/2

7800DM-16 SOCKET 1/2

7800DM-17 SOCKET 1/2

7800DM-18 SOCKET 1/2

7800DM-19 SOCKET 1/2

7809M-5 SOCKET 1/2

7809M-6 SOCKET 1/2

7809M-7 SOCKET 1/2

7809M-8 SOCKET 1/2

7809M-10 SOCKET 1/2

7809M-12 SOCKET 1/2

8150SL RATCHET 1/2, SLIM HEAD 72T

8160-1/2 EXTENSION 1/2

8162-1/2 EXTENSION 1/2

8166-1/2 UNIVERSAL JOINT 1/2

8154-1/2 T-HANDLE 1/2

8165-1/2 ADAPTOR 1/2

WRENCHES

2/3 MODULE WRENCHES COMPOSITION

- Double Open End Wrenches
- Combination Wrenches



ERGO TOOL MANAGEMENT SYSTEM



FF1F3001 - 11 pcs

6M-6-7 OPEN END WRENCH
 6M-8-9 OPEN END WRENCH
 6M-10-11 OPEN END WRENCH
 6M-12-13 OPEN END WRENCH
 6M-14-15 OPEN END WRENCH
 6M-16-18 OPEN END WRENCH
 6M-17-19 OPEN END WRENCH
 6M-20-22 OPEN END WRENCH
 6M-21-23 OPEN END WRENCH
 6M-24-27 OPEN END WRENCH
 6M-30-32 OPEN END WRENCH



FF1F3002 - 18 pcs

111M-6 COMBINATION WRENCH
 111M-7 COMBINATION WRENCH
 111M-8 COMBINATION WRENCH
 111M-9 COMBINATION WRENCH
 111M-10 COMBINATION WRENCH
 111M-11 COMBINATION WRENCH
 111M-12 COMBINATION WRENCH
 111M-13 COMBINATION WRENCH
 111M-14 COMBINATION WRENCH
 111M-15 COMBINATION WRENCH
 111M-16 COMBINATION WRENCH
 111M-17 COMBINATION WRENCH
 111M-18 COMBINATION WRENCH
 111M-19 COMBINATION WRENCH
 111M-21 COMBINATION WRENCH
 111M-22 COMBINATION WRENCH
 111M-24 COMBINATION WRENCH
 111M-27 COMBINATION WRENCH



FF1F3003 - 30 pcs

111M-6 COMBINATION WRENCH
 111M-7 COMBINATION WRENCH
 111M-8 COMBINATION WRENCH
 111M-9 COMBINATION WRENCH
 111M-10 COMBINATION WRENCH
 111M-11 COMBINATION WRENCH
 111M-12 COMBINATION WRENCH
 111M-13 COMBINATION WRENCH
 111M-14 COMBINATION WRENCH
 111M-15 COMBINATION WRENCH
 111M-16 COMBINATION WRENCH
 111M-17 COMBINATION WRENCH
 111M-18 COMBINATION WRENCH
 111M-19 COMBINATION WRENCH
 111M-20 COMBINATION WRENCH
 111M-21 COMBINATION WRENCH
 111M-22 COMBINATION WRENCH
 132OSRM-14-19 S RATCHET WR DOUBLE FLAT
 1RMA-19-1/4-SQ 19MM RATCHETING WR ADAPTOR
 1RMA-19-1/2-SQ2 19MM RATCHETING WR ADAPTOR
 1RMA-13-10-BIT BIT ADAPTOR 10 mm
 BE-9778 SCREWDRIVER SET HEX NICK. 9 PCS

■ WRENCHES

2/3 MODULE WRENCHES COMPOSITION

- Ratcheting Wrenches
- Combination Wrenches



ERGO TOOL MANAGEMENT SYSTEM



FF1F3004 - 13 pcs

111Z-3/8 COMBINATION WRENCH
 111Z-11/16 COMBINATION WRENCH
 111Z-1 COMBINATION WRENCH
 111Z-1/2 COMBINATION WRENCH
 111Z-13/16 COMBINATION WRENCH
 111Z-5/16 COMBINATION WRENCH
 111Z-5/8 COMBINATION WRENCH
 111Z-15/16 COMBINATION WRENCH
 111Z-7/16 COMBINATION WRENCH
 111Z-3/4 COMBINATION WRENCH
 111Z-1/4 COMBINATION WRENCH
 111Z-9/16 COMBINATION WRENCH
 111Z-7/8 COMBINATION WRENCH



FF1F3005 - 15 pcs

1RM-8 RATCHET WRENCH
 1RM-10 RATCHET WRENCH
 1RM-12 RATCHET WRENCH
 1RM-13 RATCHET WRENCH
 1RM-14 RATCHET WRENCH
 1RM-15 RATCHET WRENCH
 1RM-16 RATCHET WRENCH
 1RM-17 RATCHET WRENCH
 1RM-18 RATCHET WRENCH
 1RM-19 RATCHET WRENCH
 1RM-21 RATCHET WRENCH
 1RM-22 RATCHET WRENCH
 1RMA-13-10-BIT BIT ADAPTOR 10 mm
 1RMA-19-1/2-SQ2 19 mm RATCHETING WR ADAPTOR
 1RMA-19-1/4-SQ 19 mm RATCHETING WR ADAPTOR



FF1F3006 - 7 pcs

1RM-19 RATCHET WRENCH
 1RM-21 RATCHET WRENCH
 1RM-22 RATCHET WRENCH
 1RM-24 RATCHET WRENCH
 1RM-27 RATCHET WRENCH
 1RM-30 RATCHET WRENCH

MIX

3/3 MODULE MIX COMPOSITION



ERGO TOOL MANAGEMENT SYSTEM



FF1A01 - 77 pcs

A6800DM SOCKET 1/4", LONG

4, 5, 6, 7, 8, 9, 10, 11, 12, 13

6700SM SOCKET 1/4", SHORT

4, 4.5, 5, 5.5, 6, 7, 8, 9, 10, 11, 12, 13

6972H BIT HOLDER 1/4"

6950SL REVERSIBLE RATCHET 1/4", SLIMHEAD

6954 T-HANDLE 1/4"

6956 SPINNER HANDLE 1/4"

6960 EXTENSION BAR 1/4" 50 mm

6961 EXTENSION BAR 1/4" 100 mm

6966 UNIVERSAL JOINT 1/4"

7805ZZ-21 SPARK PLUG SOCKET 1/2"

7800SM SOCKET 1/2", SHORT SERIES

10, 11, 12, 13, 14, 15, 16, 17, 18, 19, 22, 24, 27, 30, 32

8150SL REVERSIBLE RATCHET 1/2", SLIMHEAD

8154-1/2 SLIDING T-HANDLE 1/2"

8159-1/2 EXTENSION BAR 1/2" 75mm

8162-1/2 EXTENSION BAR 1/2" 250 mm

8166-1/2 UNIVERSAL JOINT 1/2"

7807H BIT HOLDER 1/2"

59S/22-1 22 PCS RUBBER BIT HOLDER

PH, PZ, TORX®, SL

813 SCREWDRIVERS SLOTTED

4x100, 5.5x150 mm

815 SCREWDRIVERS PHILLIPS

PH1x100, PH2x125



FF1A02 - 19 pcs

6M OPEN END WRENCH

6x7, 8x9, 10x11, 12x13, 14x15, 16x17, 18x19, 20x22 mm

111M COMBINATION WRENCH

6, 7, 8, 10, 12, 13, 14, 17, 19, 22

808050L RATCHETING BIT SCREWDRIVER WITH LEDS



FF1A03 - 18 pcs

BE-9770 BLACK HEX KEYS SET, LONG BALL END, 9 PCS

1.5, 2, 2.5, 3, 4, 5, 6, 8, 10

2171G-160 SIDE CUTTER 160 mm

2678G-160 COMBINATION PLIER 160 mm

2971G-250 SLIP JOINT PLIER 250 mm

3734N DRIFT PUNCH 4x150, 6x150

481-400 DIN-HAMMER

306 HACKSAW FRAME AND SANDFLEX® BI-METAL BLADE

1-100-08-2-2 8" FLAT FILE, WITH HANDLE, SECOND

MTG-5-19 5m TAPE MEASURE 19mm

MIX

3/3 MODULE MIX COMPOSITION



ERGO TOOL MANAGEMENT SYSTEM



FF1A04 - 30 pcs

SARM FOUR SIZES RATCHETING WRENCH

8x11, 12x15, 16x19

111M COMBINATION WRENCH

6, 7, 8, 9, 10, 11, 12, 13, 14, 15, 16, 17, 18, 19, 21, 22, 24, 27, 30, 32

6M OPEN END WRENCH

6x7, 8x9, 10x11, 12x13, 14x15, 17x19

9071C ADJUSTABLE WRENCH CHROMED 8" ERGO™



FF1A07 - 15 pcs

3734N DRIFT PUNCH 3, 5, 6

3735N-4-120 CENTRE PUNCH

3740-175 FLAT CHISEL

SQZ150003 SQUEEZE KNIFE

1-100-08-2-2 8" FLAT FILE,
WITH HANDLE, SECOND

1-210-08-2-2 8" HALF ROUND FILE,
WITH HANDLE, SECOND

1-230-08-2-2 8" ROUND FILE, WITH HANDLE, SECOND

2744 MULTIPURPOSE SNIP 190 mm

317 HACKSAW FRAME AND SANDFLEX® BI-METAL BLADE

3625W-35 NYLON TIP HAMMER 35 mm

3745-150 CAPE CHISEL 150 mm

481-400 DIN-HAMMER

782-U UTILITY WIRE BRUSH



FF1A05 - 104 pcs

BE-9678 BLACK KEYS SET, LONG BALL END 9 PCS

1.5, 2, 2.5, 3, 4, 5, 6, 8, 10

SBS60 SOCKET 1/4"

4, 4.5, 5, 5.5, 6, 7, 8, 9, 10, 11, 12, 13, 14

SBS61 RATCHET 1/4"

SBS63 EXTENSION BARS 1/4" 50, 100, 150mm

SBS64 T-HANDLE 1/4"

SBS65 UNIVERSAL JOINT 1/4"

SBS67 BREAKER BAR 1/4"

SBS69 ADAPTOR 1/4"-3/8"

6956 SPINNER HANDLE 1/4"

6972H BIT HOLDER 1/4"

SBS80 SOCKET 1/2"

10, 11, 12, 13, 14, 15, 16, 17, 18, 19, 21, 22, 24, 27, 30, 32

8150SL REVERSIBLE RATCHET 1/2" SLIMHEAD

8160-W EXTENSION BAR 1/2"

8159-1/2 EXTENSION BAR 1/2" 75mm

8162-1/2 EXTENSION BAR 1/2" 50mm

8166-1/2 UNIVERSAL JOINT 1/2"

8154-1/2 SLIDING T-HANDLE 1/2"

SBS88 ADAPTOR 1/2"-3/8"

7809M SOCKET DRIVER 1/2", HEX

5, 6, 7, 8, 10, 12, 14, 17, 19

7809TORX SOCKET DRIVER 1/2" TORX®

T20, T25, T27, T30, T40, T45, T50, T55, T60

808050 RATCHETING BIT SCREWDRIVER

59S/31-1 BITS SET

31 PCS: PH, PZ, TORX®, HEX, SL



FF1A06 - 23 pcs

BE-8020L / BE-8040 SCREWDRIVERS ERGO™ SLOTTED
0.5X3X75, 0.8X4.0X100

BE-8150 / BE-8255 / BE- 8256 SCREWDRIVERS ERGO™
SLOTTED

1.0X5.5X100, 1.2X6.5X150, 1.6X8.0X150

BE-8350 SCREWDRIVER ERGO™ SLOTTED, STUBBY
1X5.5X25

BE-8601 SCREWDRIVER ERGO™ PHILLIPS, STUBBY
PH1X25

BE-8610 / BE-8620 SCREWDRIVERS ERGO™ PHILLIPS
PH1X75, PH2X100

BE-8910 / BE-8930 SCREWDRIVERS ERGO™ TORX®
T10X75, T15X100, T20X100, T25X125, T27X125, T30X150

MTB-3-16 TAPE MEASURE
3 m

2101 G-160IP SIDE CUTTER ERGO™

2427 G-200IP SNIPE NOSE PLIER, BENT ERGO™

2628 G-160IP COMBINATION PLIER ERGO™

8224 IP SLIP JOINT PLIER ERGO™

2951-180 GRIP WITH WIRE CUTTER

5515T-52 TELESCOPIC SWIVEL HEAD MIRROR
Ø 50 mm

2535L MAGNETIC PICK-UP WITH LIGHT

MIX

3/3 MODULE MIX COMPOSITION



ERGO TOOL MANAGEMENT SYSTEM



FF1A08 - 138 pcs

6700SM SOCKET 1/4", SHORT

5.5, 6, 7, 8, 9, 10, 11, 12, 13

A6800DM SOCKET 1/4", LONG

5.5, 6, 7, 8, 9, 10, 11, 12, 13

6709M SOCKET DRIVER 1/4", HEX

3, 4, 5, 6, 8

6709PH SOCKET DRIVER 1/4", PH

1, 2, 3

6709TORX SOCKET DRIVER 1/4", TORX®

T8, T9, T10, T15, T20, T25, T27, T30, T40

6950SL REVERSIBLE RATCHET 1/4", SLIMHEAD

6954 T-HANDLE 1/4"

6956 SPINNER HANDLE 1/4"

6958 BREAKER BAR 1/4"

6960 / 6961 / 6962 / 6962L EXTENSION BARS 1/4"

50, 100, 150, 355 mm

6966 UNIVERSAL JOINT 1/4"

6972H BIT HOLDER 1/4"

7764 ADAPTOR F 3/8" - M 1/4"

7400SM SOCKET 3/8", SHORT SERIES

6, 7, 8, 9, 10, 11, 12, 13, 14, 15, 16, 17, 18, 19, 22

A7402DM SOCKET 3/8", LONG

10, 11, 12, 13, 14, 15, 16, 17, 18, 19

7409M SOCKET DRIVER 3/8" HEX

3, 4, 5, 6, 7, 8, 10

7409TORX SOCKET DRIVER 3/8", TORX®

T25, T27, T30, T40, T45, T50

7750SL RATCHET 3/8" SLIMHEAD

7754 T-HANDLE 3/8"

7758 BREAKER BAR 3/8"

7760 / 7761 / 7762

EXTENSION BARS 3/8"

75, 125, 250 mm

7766 UNIVERSAL JOINT 3/8"

7765 ADAPTOR F 1/4" - M 3/8"

8164-1/2 ADAPTOR F 3/8" - M 1/2"

7407H SOCKET HOLDER 3/8"

1/4" - 3/8"

7800SM SOCKET 1/2" SHORT 10, 11, 12, 13, 14, 15, 16, 17,

18, 19, 21, 22, 24, 27, 30, 32

7809M SOCKET DRIVER 1/2", HEX

5, 6, 7, 8, 10, 12, 14, 17, 19

7809TORX SOCKET DRIVER 1/2", TORX®

T20, T25, T27, T30, T40, T45, T50, T55, T60

8154-1/2 T-HANDLE 1/2"

8150SL RATCHET 1/2", SLIMHEAD

8160-1/2 EXTENSION BAR 1/2",

125 mm

8162-1/2 EXTENSION BAR 1/2"

250 mm

8166-1/2 UNIVERSAL JOINT 1/2"

8165-1/2 ADAPTOR F 1/2" - M 3/8"

8964 ADAPTOR F 1/2" - M 3/4"

7807H SOCKET HOLDER 1/2"

2058-BR BIT-RATCHET 1/4"

1544 FEELER GAUGE



FF1A09 - 34 pcs

111M COMBINATION WRENCH

6, 7, 8, 9, 10, 11, 12, 13, 14, 15, 16, 17, 18, 19, 21, 22, 24, 27, 30, 32

6M OPEN END WRENCH

6x7, 8x9, 10x11, 12x13, 14x15, 16x17, 18x19, 20x22, 24x27, 30x32

9071C ADJUSTABLE WRENCH CHROMED 8" ERGO™

1320RM RATCHET RING WRENCH

8x9, 10x11, 12x13

MIX

3/3 MODULE MIX COMPOSITION



ERGO TOOL MANAGEMENT SYSTEM

**FF1A10 - 66 pcs**

808050P PISTOL HANDLE RATCHETING SCREWDRIVER

808050S RATCHETING SCREWDRIVER, STUBBY

59S/S31-1 BITS SET 31 PCS: PH, PZ, TORX®, HEX, SL

2047-0.8-4 OFFSET SCREWDRIVER 0.8X4X100

2047PR-1-2 DOUBLE OFFSET KEY FOR PHILLIPS SCREWS PH1 & 2

BE-8020L SCREWDRIVER ERGO™, SLOTTED 0,5X3X75

BE-8030 SCREWDRIVER ERGO™ SLOTTED 0,6X3,5X75

BE-8155 SCREWDRIVER ERGO™, SLOTTED 1,2X6,5X125

BE-8260 SCREWDRIVER ERGO™

SLOTTED, HEX PROFILE & BOLSTER 1,6X8,0X175

BE-8350 SCREWDRIVER ERGO™ SLOTTED, STUBBY

1X5,5X25

BE-8601 / BE-8602 SCREWDRIVERS ERGO™, PHILLIPS, STUBBY PH1X25, PH2X25

BE-8610 / BE-8630 SCREWDRIVERS ERGO™, PHILLIPS PH1X75, PH2X100, PH3X150

BE-8910 / BE-8620 / BE-8940 SCREWDRIVERS ERGO™, TORX® T10X75, T15X100, T20X100, T25X125, T27X125, T30X150, T40X150

BE-9770 BLACK HEX KEYS SET, LONG BALL END, 9 PCS HEX 1.5, 2, 2.5, 3, 4, 5, 6, 8, 10

MTB-3-16 MEASURING TAPE 3 m

1150-1/2H/P CALIPER 150 mm

1177-SCRIBE OFFSET SCRIBER 230 mm

5515T-52 TELESCOPIC SWIVEL HEAD MIRROR Ø 50 mm

2820EF2 ELECTRICIANS KNIFE 200 mm

**FF1A11 - 16 pcs**

2101GC SIDE CUTTERS ERGO™

125, 160 mm

21HDGC-200IP SIDE CUTTERS ERGO™

200 mm

2427 GC-200IP LONG, ROUND NOSE CHROMED PLIER, ERGO™ 200 mm

2430 GC-200 IP SNIPER NOSE CHROMED PLIER, ERGO™ 200 mm

2628 GC-160IP COMBINATION CHROMED PLIER, ERGO™ 160 mm

8224CIP SLIP JOINT PLIER, ERGO™

2951-250 GRIP WITH WIRE CUTTER

250 mm

2952-165 GRIP WITH EXTRA LONG NOSE

2928-160 PLIER, FOR INTERNAL & EXTERNAL CIRCLIPS INT. 7-26 mm, EXT. 3-26 mm

2928-200 PLIER, FOR INTERNAL & EXTERNAL CIRCLIPS INT. 10-51 mm, EXT. 7-51 mm

2928-250 PLIER, FOR INTERNAL & EXTERNAL CIRCLIPS INT. 46-102 mm, EXT. 32-102 mm

2928-1 / 2928-4 SPARE TIPS FOR 2928 SERIES

BFLA01 Q3 LED-TORCH

**FF1A12 - 19 pcs**

481-300 / 481-500 DIN HAMMER

300, 500 mm

3625W-35 NYLON TIP HAMMER

8158-1/2 BREAKER BAR 380 mm

2509 FLEXIBLE PICK-UP TOOL 525 mm

2535F2 MAGNETIC PICK-UP TOOL 1 kg

3734 DRIFT PUNCHES

Ø 3, 5, 8 mm

3735-4-120 CENTRE PUNCH

120 mm

3740-150 FLAT CHISEL

150 mm

3745-150 CAPE CHISEL

150 mm

1-100-06-1-2 6" FLAT FILE

WITH HANDLE, BASTARD

1-100-06-2-2 6" FLAT FILE,

WITH HANDLE, SECOND

1-160-06-1-2 6" SQUARE FILE,

WITH HANDLE, BASTARD

1-210-06-1-2 6" HALF ROUND FILE,

WITH HANDLE, BASTARD

1-230-06-1-2 6" ROUND FILE, WITH HANDLE, BASTARD

FS-8 SCISSORS

7,5 cm BLADE

319 HACKSAW FRAME AND

BI-METAL SANDFLEX® BLADE

MIX

3/3 MODULE MIX COMPOSITION



ERGO TOOL MANAGEMENT SYSTEM



FF1A13 - 82 pcs

A6800DZ SOCKETS 1/4" LONG

3/16", 7/32", 1/4", 9/32", 5/16", 11/32", 3/8", 7/16", 1/2", 9/16"

A6800DM SOCKETS 1/4", LONG

4", 10"

6700SZ-5/32 SOCKET 1/4", SHORT

A6700DZ SOCKETS 1/4", SHORT

3/16", 7/32", 1/4", 9/32", 5/16", 11/32", 3/8", 7/16", 1/2", 9/16"

A6710DZ SWIVEL SOCKETS 1/4", LONG

3/16", 7/32", 1/4", 9/32", 5/16", 11/32", 3/8", 7/16", 1/2", 9/16"

6966 UNIVERSAL JOINT 1/4"

6950SL REVERSIBLE RATCHET 1/4", SLIMHEAD

6958 BREAKER BAR 1/4"

6954 T-HANDLE 1/4"

6956 SPINNER HANDLE 1/4"

6960 / 6961 / 6962 / 6962L EXTENSION BARS 1/4"
50, 100, 150, 355 mm

A7400DZ SOCKET 3/8" SHORT 1/4", 5/16", 3/8", 7/16", 1/2", 17/32", 9/16", 19/32", 5/8", 11/16", 3/4", 13/16", 7/8"

A7402DZ SOCKETS 3/8" LONG

1/4", 5/16", 3/8", 7/16", 1/2", 9/16", 5/8", 19/32", 11/16", 3/4", 13/16", 7/8"

7766 UNIVERSAL JOINT 3/8"

7750SL RATCHET 3/8", SLIMHEAD

7758 BREAKER BAR 3/8"

7754 T-HANDLE 3/8"

7752 SPEEDER 3/8"

7760 / 7761 / 7762 EXTENSION BARS 3/8"
75, 125, 250 mm

7764 ADAPTOR F 3/8" - M 1/4"

7765 ADAPTOR F 1/4" - M 3/8"

8165-1/2 ADAPTOR F 1/2" - M 3/8"

8164-1/2 ADAPTOR F 3/8" - M 1/2"

6972H BIT HOLDER 1/4"

7407H BIT HOLDER 3/8" 1/4" - 3/8"

7408H BIT HOLDER 3/8" - 5/16" - 3/8"

S6106KA SOCKET SPARK PLUG 7/8"



FF1A14 - 43 pcs

111Z COMBINATION WRENCHES

1/4", 5/16", 3/8", 7/16", 1/2", 9/16", 5/8", 11/16", 3/4", 13/16", 7/8", 15/16", 1"

1952Z-11/32 COMBINATION WRENCH 11/32"

1320RZ RATCHETING RING WRENCHES

1/4X5/16", 5/16X11/32", 3/8X7/16", 1/2X9/16"

1950MZ-3/8 CROWFOOT ADJUSTABLE WRENCH 3/8"

8069 C IP ADJUSTABLE CHROMED WRENCH 4" 110X13 mm

9070C ADJUSTABLE WRENCH CHROMED 6" ERGO™ 158x20 mm

1931Z LILIPUT DOUBLE OPEN-END WRENCHES 5/32", 3/16", 7/32", 1/4", 9/32", 5/16", 11/32", 3/8", 7/16", 1/2", 9/16"

6Z DOUBLE OPEN-END WRENCHES

1/4X5/16", 5/16X11/32", 3/8X7/16, 1/2X9/16", 19/32X11/16", 5/8X3/4", 25/32X13/16", 7/8X15/16", 15/16X1", 1X1.1/8", 1.1/16X1.1/4"



FF1A15 - 12 pcs

8224CIP SLIP JOINT PLIER, ERGO™

2628 GC-160IP COMBINATION CHROMED PLIER, ERGO™ 160 mm

2101GC SIDE CUTTING PLIER 125, 160 mm

2233D-240IP CABLE CUTTING PLIER 240 mm

2430 GC-200IP SNIPE NOSE PLIER 200 mm

2427 GC-200IP LONG, ROUND NOSE CHROMED PLIER, ERGO™ 200 mm

2421GC-180IP FLAT NOSE PLIER 180 mm

2650 SLIP JOINT, CONNECTOR PLIER

2951-180 GRIP & WELDING PLIER 180 mm

2855 WIRE TWISTING PLIER 224 mm

2855 D WIRE TWISTING PLIER 282 mm

MIX

3/3 MODULE MIX COMPOSITION



ERGO TOOL MANAGEMENT SYSTEM



FF1A16 - 18 pcs

5515T POCKET TELESCOPIC MIRROR

Ø 30 mm

5515T-52 TELESCOPIC SWIVEL HEAD MIRROR

Ø 50 mm

1544 FEELER GAUGE

1150-1/2H/P CALIPER

150 mm

1179-FLX-2 FLEXIBLE MEASURE ROD

300 mm

MTB-3-16-E MEASURING TAPE

3 m

5471 F-145 GENERAL PURPOSE TWEEZER, STRAIGHT

145 mm

5516 GENERAL PURPOSE TWEEZER, ANGLE

150 mm

2744 MULTIPURPOSE SNIP

190 mm

2820EF2 ELECTRICIAN'S KNIFE WITH PLASTIC HANDLE

200 mm

2632 COMBINATION COTTER PIN EXTRACTOR AND

SPREADER

170 mm

1177-SCRIBE OFFSET SCRIBER 230 mm

3525HB THREE SQUARE MACHINIST'S SCRAPER

80/165 mm

268 JUNIOR HACKSAW 150 mm

2509 FLEXIBLE PICK-UP TOOL 525 mm

2535F2 MAGNETIC PICK-UP TOOL 1 kg

KE18-01 CUTTER KNIFE ERGO™

BFLA01 Q3 LED TORCH



FF1A17 - 61 pcs

BE-9780 BLACK HEX KEYS SET,

LONG BALL END, 12 PCS

0.050", 1/16", 5/64", 3/32", 7/64", 1/8", 9/64", 5/32", 3/16",
7/32", 1/4", 5/16"

BE-8020L / BE-8220 SLOTTED SCREWDRIVERS, ERGO™

0.5x3x75 mm, 0.5x3x125 mm

BE-8150 / BE-8155 SLOTTED SCREWDRIVERS, ERGO™

1x5.5x100 mm, 1.2x6.5x125 mm

BE-8260 SCREWDRIVER ERGO™

SLOTTED

1.6X8,0X175

BE-8610 / BE-8620 / BE-8630 PHILLIPS SCREWDRIVERS,
ERGO™

PH1X75 mm, PH2X100 mm, PH3X150 mm

BE-8601 / BE-8602 PHILLIPS SCREWDRIVERS, ERGO™

PH1X25 mm, PH2X25 mm

2047-1-5.5 DOUBLE OFFSET KEY FOR SLOTTED SCREWS

1X5.5X125 mm

2047PR-1-2 DOUBLE OFFSET KEY FOR PHILLIPS SCREWS

PH1 & 2

706-2 PRECISION SCREWDRIVERS SET, FOR SLOTTED &

PHILLIPS SCREWS

1.0X50, 1.2X50, 1.5X50, 1.8X50 mm, PH0, PH00

2058-BR BIT-RATCHET 1/4"

59/S28-4 BITS SET FOR SLOTTED, PHILLIPS, TORX®,

HEXAGON AND TORQ-SET® HEAD SCREWS

28 PCS

BE-8350 SCREWDRIVER ERGO™

SLOTTED, STUBBY

1X5.5X25

808050 RATCHETING BIT SCREWDRIVER



FF1A18 - 25 pcs

3736S/6 SET OF CHISELS

6 PCS

3734S/6 SET OF DRIFT PUNCHES,

6 PCS

2-8 x 150 Ø mm

481 DIN HAMMER

200, 500 gr

3625N-35 SUPERFLEX PLASTIC HAMMER

35 mm

782-U GENERAL PURPOSE UTILITY WIRE BRUSH

290 mm

1-476-04-3-2 4" HAND FILE SET,

WITH HANDLE: HAND, WARDING, SQUARE, THREE SQUARE,
HALF ROUND AND ROUND

2633/S4 SET INCLUDES AWL, HOOKS & PICKS, 4 PCS

MIX

3/3 MODULE MIX COMPOSITION



ERGO TOOL MANAGEMENT SYSTEM



FF1A20 - 32 pcs

2M-20-22 RING WRENCH

2M-21-23 RING WRENCH

2M-24-27 RING WRENCH

2M-25-28 RING WRENCH

2M-30-32 RING WRENCH

4040M-10-11 FLEX HEAD SPANNER 10-11 MM

4040M-12-13 FLEX HEAD SPANNER 12-13 MM

4040M-14-15 FLEX HEAD SPANNER 14-15 MM

4040M-16-17 FLEX HEAD SPANNER 16-17 MM

4040M-18-19 FLEX HEAD SPANNER 18-19 MM

4040M-20-22 FLEX HEAD SPANNER 20-22 MM

4040M-21-23 FLEX HEAD SPANNER 21-23 MM

4040M-8-9 FLEX HEAD SPANNER 8-9 MM

6700SM-10 SOCKET 1/4

6700SM-11 SOCKET 1/4

6700SM-12 SOCKET 1/4

6700SM-13 SOCKET 1/4

6700SM-14 SOCKET 1/4

6700SM-4 SOCKET 1/4

6700SM-4.5 SOCKET 1/4

6700SM-5 SOCKET 1/4

6700SM-5.5 SOCKET 1/4

6700SM-6 SOCKET 1/4

6700SM-7 SOCKET 1/4

6700SM-8 SOCKET 1/4

6700SM-9 SOCKET 1/4

6950 RATCHET 1/4, PEAR TYPE 72T

6954 T-HANDLE

6956 SPINNER HANDLE 1/4

6960 EXTENSION 1/4 50MM

6962 EXTENSION 1/4 150MM

6966 UNIVERSAL JOINT



FF1A5023 - 16 pcs

319-3906 HACKSAW FRAME 319

268 MINI HACKSAW FRAMES

208 HACKSAW FRAMES

2509 FLEX. PICK UP

2444 CARPENTERS INMORA KNIFE IN

2744 MULTI-PURPOSE SNIP

5515T TELESCOPIC MIRROR

BE-8020L SCREW.DR ERGO 0,5X3X75

BE-8040 SCREW.DR ERGO 0,8X4,0X100

BE-8150 SCREW.DR ERGO 1,0X5,5X100

BE-8255 SCREW.DR ERGO 1,2X6,5X150

BE-8256 SCREW.DR ERGO 1,6X8,0X150

BE-8340 SCREW.DR ERGO 0,8X4X25

BE-8601 SCREW.DR ERGO PH1X25

BE-8610 SCREW.DR ERGO PH1X75

BE-8620 SCREW.DR ERGO PH2X100

MIX

3/3 MODULE MIX COMPOSITION



ERGO TOOL MANAGEMENT SYSTEM



FF1A5016 - 28 pcs

111M-6, 7, 8, 9, 10, 11, 12, 13, 14, 15, 16, 17, 18, 19, 20,
COMBINATION WRENCH
1419-MD MAGNETIC DISH
BE-8906 SCREW.DR ERGO TX 6X75
BE-8907 SCREW.DR ERGO TX 7X75
BE-8908 SCREW.DR ERGO TX 8X75
BE-8909 SCREW.DR ERGO TX 9X75
BE-8910 SCREW.DR ERGO TX 10X75
BE-8915 SCREW.DR ERGO TX 15X100
BE-8920 SCREW.DR ERGO TX 20X100
BE-8925 SCREW.DR ERGO TX 25X125
BE-8927 SCREW.DR ERGO TX 27X125
BE-8930 SCREW.DR ERGO TX 30X150
BE-8940 SCREW.DR ERGO TX 40X150
BE-8945 SCREW.DR ERGO TX 45X150



FF1A5017 - 16 pcs

3625N-35 PLASTIC HAMMER
3734-2 DRIFT PUNCH
3734-3 COTTER PIN PUNCH
3734-4 BOTADOR
3734-5 COTTER PIN PUNCH
3734-6 DRIFT PUNCH
3734-8 COTTER PIN PUNCH
3735-5-120 CENTER PUNCH
3740-175 FLAT CHISEL
481-400 GERMAN DIN-HAMMER
111M-21, 22, 24, 27, 30, 32, COMBINATION WRENCH



FF1A5018 - 26 pcs

2628 G-180IP COMB PLIER 2628 G-180IP
2101G-160IP SIDE CUTTER 2101G-160IP
2430 G-160 IP SNIPE NOSE CUTTING 160 IP
8224 IP SLIP JOINT PLIER 8224 W/O CARD
BBR201P6 XZN 1/2 IMP SOCK BIT- BRAKE 6P
BE5103 XZN 1/2 SOCKET W/BIT-ENG 9P
2M-10-11 RING WRENCH
2M-12-13 RING WRENCH
2M-14-15 RING WRENCH
2M-16-17 RING WRENCH
2M-18-19 RING WRENCH
2M-6-7 RING WRENCH
2M-8-9 RING WRENCH

MIX

3/3 MODULE MIX COMPOSITION



ERGO TOOL MANAGEMENT SYSTEM



FF1A2502 - 117 pcs

59S/31-1 BITS SET 31PCS PH.PZ.T.HEX.SL

7400SM-6, 7, 8, 9, 10, 11, 12, 13, 14, 15, 16, 17, 18, 19, 20,
21, 22, SOCKET 3/8

7754 T-HANDLE 3/8

7755-3/8 RATCHET 3/8, ERGO

7760 EXTENSION 3/8, 75MM

7761 EXTENSION 3/8, 125MM

7762 EXTENSION 3/8, 250MM

7766 UNIVERSAL JOINT 3/8

7800SM- 8, 9, 10, 11, 12, 13, 14, 15, 16, 17, 18, 19, 21, 22,
23, 24, 26, 28, 30, 32, SOCKET 1/2

7805DM-10, 12, 13, 17, 19, SOCKET 1/2

7809M-5, 6, 7, 8, 9, 10, 12, 14, 17, 19 SOCKET DRIVER 1/2,
HEX 10

7809M-10-140 SOCKET DRIVER 1/2IN HEX.LONG

7809M-5-180 SOCKET DRIVER 1/2IN HEX.LONG

7809M-6-140 SOCKET DRIVER 1/2IN HEX.LONG

7809M-7-100 SOCKET DRIVER 1/2IN HEX.LONG

7809M-8-120 SOCKET DRIVER 1/2IN HEX.LONG

7809TORX-T25, T30, T40, T45, T50, T55, SOCKET 1/2

808050 RATCHETING BIT SCREWDRIVER

8154-1/2 T HANDLE

8155-1/2 ONE HANDLE RATCHET 1/2IN

8160-1/2 EXTENSION

8162-1/2 EXTENSION

8166-1/2 UNIVERSAL JOINT

BE-9678 SCREW.DR SET HEX BALL 9 PCS

MTB-5-25 5M TAPE MEASURE 25MM

■ MIX

3/3 MODULE MIX COMPOSITION



ERGO TOOL MANAGEMENT SYSTEM

**FF1A5019 - 47 pcs**

111M COMBINATION WRENCH 6, 7, 8, 9, 10, 11, 12, 13, 14, 15, 16, 17, 18, 19, 20 mm

2101G-160IP SIDE CUTTER 160 mm

2430 G-160 IP SNIPE NOSE CUTTING 160 mm

2628 G-180IP COMBINATION PLIER 160 mm

7800DM SOCKET 1/2 8, 9, 10, 11, 12, 13, 14, 15, 16, 17, 18, 19, 20, 21, 22, 23, 24, 25, 26, 27, 28, 30, 32 mm

8154-1/2 T HANDLE 1/2

8155-1/2 RATCHET 1/2

8160-1/2 EXTENSION 125 mm

8162-1/2 EXTENSION 250 mm

8166-1/2 UNIVERSAL JOINT 1/2

8224 IP SLIP JOINT PLIER 250 mm

**FF1A1008 - 55 pcs**

59S/31-1 PZ1, PZ2 (x3), PZ3, PH1, PH2 (x3), PH3; PH2G (x2); T10, T15 (x3), T20 (x3), T25 (x2), T27 and T30. SL: 3, 4.5, 5.5mm; HEX: 3mm, 4, 5, 6mm. 1/4 " Magnetic bit holder

BE-8020L SCREWDRIVER ERGO 0.5 X 3 X 75

808050 RATCHETING BIT SCREWDRIVER

BE-8040 SCREWDRIVER ERGO 0.8 X 4,0 X 100

BE-8150 SCREWDRIVER ERGO 1.0 X 5,5 X 100

BE-8255 SCREWDRIVER ERGO 1.2 X 6,5 X 150

BE-8256 SCREWDRIVER ERGO 1.6 X 8,0 X 150

BE-8340 SCREWDRIVER ERGO 0.8 X 4 X 25

BE-8601 SCREWDRIVER ERGO PH1 X 25

BE-8610 SCREWDRIVER ERGO PH1 X 75

BE-8620 SCREWDRIVER ERGO PH2 X 100

BE-8925 SCREWDRIVER ERGO TORX 25 X 125

BE-8927 SCREWDRIVER ERGO TORX 27 X 125

BE-8930 SCREWDRIVER ERGO TORX 30 X 150

BE-8940 SCREWDRIVER ERGO TORX 40 X 150

BE-8945 SCREWDRIVER ERGO TORX 45 X 150

BE-9678 BLACK KEYS SETS FOR HEX SCREWS, LONG BALL END 1.5, 2, 2.5, 3, 4, 5, 6, 8, 10

MIX

3/3 MODULE MIX COMPOSITION



ERGO TOOL MANAGEMENT SYSTEM



FF1A5020 - 52 pcs

111M COMBINATION WRENCH 6, 7, 8, 9, 10, 11, 12, 13, 14, 15, 16, 17, 18, 19, 20 mm

3625N-35 PLASTIC HAMMER

2951-180 GRIP 180 mm

2951-250 GRIP 250 mm

7800DM SOCKET 1/2 8, 9, 10, 11, 12, 13, 14, 15, 16, 17, 18, 19, 20, 21, 22, 23, 24, 25, 26, 27, 28, 30, 32 mm

7805DM 1/2 DEEP SOCKET 10, 12, 13, 17, 19

8154-1/2 T HANDLE 1/2

8155-1/2 RATCHET 1/2

8160-1/2 EXTENSION 125 mm

8162-1/2 EXTENSION 250 mm

8166-1/2 UNIVERSAL JOINT 1/2

8224 IP SLIP JOINT PLIER 250 mm



FF1A5021 - 17 PCS

BE-8020L SCREWDRIVER ERGO 0,5 X 3 X 75

BE-8040 SCREWDRIVER ERGO 0,8 X 4,0 X 100

BE-8150 SCREWDRIVER ERGO 1,0 X 5,5 X 100

BE-8255 SCREWDRIVER ERGO 1,2 X 6,5 X 150

BE-8256 SCREWDRIVER ERGO 1,6 X 8,0 X 150

BE-8340 SCREWDRIVER ERGO 0,8 X 4 X 25

BE-8601 SCREWDRIVER ERGO PH1 X 25

BE-8610 SCREWDRIVER ERGO PH1 X 75

BE-8620 SCREWDRIVER ERGO PH2 X 100

319-3906 HACKSAW FRAME

MTB-5-25 5M TAPE MEASURE 25 mm

208-3906 HACKSAW FRAMES

2444 CARPENTERS KNIFE

268 MINIHACKSAW FRAMES

5515T TELESCOPIC MIRROR

2509 FLEXIBLE PICK UP

2744 MULTI-PURPOSE SNIPE

MIX

3/3 MODULE MIX COMPOSITION



ERGO TOOL MANAGEMENT SYSTEM



FF1A5022 - 26 pcs

6700SM SOCKET 1/4: 4, 4.5, 5, 5.5, 6, 7, 8, 9, 10, 11, 12, 13, 14 mm

6950 RATCHET 1/4 PEAR TYPE

6954 T-HANDLE

6956 SPINNER HANDLE 1/4

6960 EXTENSION 1/4 50 mm

6962 EXTENSION 1/4 150 mm

6966 UNIVERSAL JOINT 1/4

8070 ADJUSTABLE WRENCH 6"

9031 ADJUSTABLE WRENCH

9072 P COMBINATION ADJUSTABLE WRENCH P 10"

141 PIPE WRENCH

2101G-160IP SIDE CUTTER 160 mm

2430 G-160 IP SNIPE NOSE CUTTING 160 mm

2628 G-180IP COMBINATION PLIER 180 mm



FF1A1009 - 49 pcs

901T-010-100 TORX T-HANDLE 10 X 100

901T-015-150 TORX T-HANDLE 15 X 150

901T-020-150 TORX T-HANDLE 20 X 150

901T-025-150 TORX T-HANDLE 25 X 150

901T-027-150 TORX T-HANDLE 27 X 150

901T-030-200 TORX T-HANDLE 30 X 200

901T-040-200 TORX T-HANDLE 40 X 200

808050 RATCHETING BIT SCREWDRIVER

59S/31-1 PZ1, PZ2 (x3), PZ3; PH1, PH2 (x3), PH3; PH2G (x2); T10, T15 (x3), T20 (x3), T25 (x2), T27, T30. SL: 3, 4.5, 5.5 mm; HEX: 3 mm, 4, 5, 6 mm 1/4" Magnetic bit holder

1419-MD MAGNETIC DISH

BE-9678 BLACK KEYS SETS FOR HEX SCREWS, LONG BALL END 1.5, 2, 2.5, 3, 4, 5, 6, 8, 10 mm

MIX

3/3 MODULE MIX COMPOSITION



ERGO TOOL MANAGEMENT SYSTEM



FF1A5021 - 16 pcs

208-3906 HACKSAW FRAMES

2444 CARPENTERS KNIFE

2509 FLEX. PICK UP

268 MINI HACKSAW FRAMES

2744 MULTI-PURPOSE SNIP

319-3906 HACKSAW FRAME

5515T TELESCOPIC MIRROR

BE-8020L SCREWDRIVER ERGO 0,5 X 3 X 7BE-8040

BE-8040 SCREWDRIVER ERGO 0,8 X 4,0 X 100

BE-8150 SCREWDRIVER ERGO 1,0 X 5,5 X 100

BE-8255 SCREWDRIVER ERGO 1,2 X 6,5 X 150

BE-8256 SCREWDRIVER ERGO 1,6 X 8,0 X 150

BE-8340 SCREWDRIVER ERGO 0,8 X 4 X 25

BE-8601 SCREWDRIVER ERGO PH1 X 25

BE-8610 SCREWDRIVER ERGO PH1 X 75

BE-8620 SCREWDRIVER ERGO PH2 X 100



FF1A5022 - 28 pcs

111M COMBINATION WRENCH 6, 7, 8, 9, 10, 11, 12, 13 mm

1RM RATCHET COMB.SPANNER 8, 9, 10, 11, 12, 13, 14, 15, 16, 17, 18, 19 mm

2101G-160IP SIDE CUTTER 160 mm

2430 G-160 IP SNIPE NOSE CUTTING 160 mm

141 PIPE WRENCH

2628 G-180IP COMBINATION PLIER 180 mm

9031 ADJUSTABLE WRENCH

9072 P COMB ADJUSTABLE P 10"

8070 ADJUSTABLE WRENCH 6"

8224 IP SLIP JOINT PLIER 250 mm

MIX

3/3 MODULE MIX COMPOSITION



ERGO TOOL MANAGEMENT SYSTEM



FF1A5025 - 57 pcs

1419-MD MAGNETIC DISH

59/S31 IMPACT BITS SET 31 PCS

BE-9678 BLACK KEYS SETS FOR HEX SCREWS,
LONG BALL END 1.5, 2, 2.5, 3, 4, 5, 6, 8, 10 mm

7809M SOCKET 1/2, HEX 5, 6, 7, 8, 9, 10, 12, 14, 17, 19 mm

7809M-10-140 SOCKET 1/2 HEX.LONG

7809M-5-180 SOCKET 1/2 HEX.LONG

7809M-6-140 SOCKET 1/2 HEX.LONG

7809M-7-100 SOCKET 1/2 HEX.LONG

7809M-8-120 SOCKET 1/2 HEX.LONG

808050 RATCHETING BIT SCREWDRIVER



FF1A5026 - 84 pcs

6700SM SOCKET 1/4 4, 4.5, 5, 5.5, 6, 7, 8, 9, 10, 11, 12,
13, 14 mm

6950 RATCHET 1/4, PEAR TYPE Z2T

6954 T-HANDLE 1/4

6956 SPINNER HANDLE 1/4

6960 EXTENSION 1/4 50 mm

6962 EXTENSION 1/4 150 mm

6966 UNIVERSAL JOINT 1/4

7400SM SOCKET 3/8 6, 7, 8, 9, 10, 11, 12, 13, 14, 15, 16, 17,
18, 19, 20, 21, 22 mm

7754 T-HANDLE 3/8

7755-3/8 RATCHET 3/8, ERGO

7760 EXTENSION 3/8, 75 mm

7761 EXTENSION 3/8, 125 mm

7762 EXTENSION 3/8, 250 mm

7766 UNIVERSAL JOINT 3/8

7800DM SOCKET 1/2 8, 9, 10, 11, 12, 13, 14, 15, 16, 17, 18,
19, 20, 21, 22, 23, 24, 25, 26, 27, 28, 29, 30, 32 mm

7805DM 1/2 DEEP SOCKET 10, 12, 13, 17, 19 mm

8154-1/2 T HANDLE 1/2

8155-1/2 RATCHET 1/2

8160-1/2 EXTENSION 125 mm

8162-1/2 EXTENSION 250 mm

8166-1/2 UNIVERSAL JOINT 1/2

111M COMBINATION WRENCH 14, 15, 16, 17, 18, 19, 20 mm

MTB-5-25 5M TAPE MEASURE 25 mm

MIX

3/3 MODULE MIX COMPOSITION



ERGO TOOL MANAGEMENT SYSTEM



FF1A19 - 33 pcs

111M - COMBINATION WRENCH 6, 7, 8, 9, 10, 11, 12, 13, 14,

15, 16, 17, 18, 19, 20, 21, 22, 24, 27, 30, 32 mm

6M - OPEN END WRENCH 6-7, 8-9, 10-11, 12-13, 14-15,

16-17, 18-19, 20-22, 21-23, 24-27, 30-32

92C ADJUSTABLE WRENCH 8" SIDE NUT



FF1A20 - 18 pcs

2M-6-7 RING WRENCH

2M-8-9 RING WRENCH

2M-10-11 RING WRENCH

2M-12-13 RING WRENCH

2M-14-15 RING WRENCH

2M-16-17 RING WRENCH

2M-18-19 RING WRENCH

2M-20-22 RING WRENCH

2M-21-23 RING WRENCH

2M-24-27 RING WRENCH

2M-30-32 RING WRENCH

4040M-10-11 FLEX HEAD SPANNER 10-11 mm

4040M-12-13 FLEX HEAD SPANNER 12-13 mm

4040M-14-15 FLEX HEAD SPANNER 14-15 mm

4040M-16-17 FLEX HEAD SPANNER 16-17 mm

4040M-18-19 FLEX HEAD SPANNER 18-19 mm

4040M-21-23 FLEX HEAD SPANNER 21-23 mm

2953-250 UNIV.LOCKING CURVED PLIER 250



FF1A21 - 51 pcs

59S/31-1 BITS SET 31PCS PH,PZ,T.HEX,SL

BE-8257 SCREW.DR ERGO 1,6X8,0X175

BE-8255 SCREW.DR ERGO 1,2X6,5X150

BE-8242 SCREW.DR ERGO 1,0X5,5X150

BE-8040 SCREW.DR ERGO 0,8X4,0X100

BE-8030 SCREW.DR ERGO 0,6X3,5X75

BE-8611 SCREW.DR ERGO PH1X75

BE-8620 SCREW.DR ERGO PH2X100

BE-8910 SCREW.DR ERGO TX 10X75

BE-8915 SCREW.DR ERGO TX 15X100

BE-8920 SCREW.DR ERGO TX 20X100

BE-8925 SCREW.DR ERGO TX 25X125

BE-8927 SCREW.DR ERGO TX 27X125

BE-8930 SCREW.DR ERGO TX 30X150

BE-8940 SCREW.DR ERGO TX 40X150

BE-8577 SCREW.DR ERGO 1/4 BIT HOLDER

BE-8355 SCREW.DR ERGO 1,2X6,5X25

BE-8602 SCREW.DR ERGO PH2X25

2446 STAINLESS STEEL CARPENTER KNIF

BE-9678 SCREW.DR SET HEX BALL 9 PCS

BE-9575 SCREW.DR SET TORX 8PCS

■ MIX

3/3 MODULE MIX COMPOSITION



ERGO TOOL MANAGEMENT SYSTEM

**FF1A22 - 58 pcs**

7800SM-10, 12, 13, 14, 15, 16, 17, 18, 19, 21, 22,
23, 24, 27, 30, 32, SOCKET 1/2

7805SM-13, 16, 17, 18, 19, 21, 22, 24, 27, 30, 32
SOCKET DEEP 1/2

7809M-5, 6, 8, 10, 12, 14 SOCKET DRIVER 1/2

8158-1/2 BREAKER BAR

8154-1/2 T HANDLE

8159-1/2 EXTENSION

8160-1/2 EXTENSION

8166-1/2 UNIVERSAL JOINT

8150SL RATCHET 1/2, SLIM HEAD 72T

6700SM-4, 4.5, 5, 5.5, 6, 7, 8, 9, 10, 11, 12, 13,
SOCKET 1/4

6958 BREAKER BAR

6954 T-HANDLE

6960 EXTENSION 1/4 50 mm

6962 EXTENSION 1/4 150M mm

6966 UNIVERSAL JOINT

6950SL RATCHET 1/4, SLIM HEAD 72T

4532-A UNIV. TWO-ARM PULLER

**FF1A23 - 21 pcs**

3735-4-120 PUNCH

3734-2 COTTER PIN PUNCH

3734-3 COTTER PIN PUNCH

3734-4 COTTER PIN PUNCH

3734-5 COTTER PIN PUNCH

3734-6 COTTER PIN PUNCH

3734-8 COTTER PIN PUNCH

2630GC-180IP COMBINATION PLIER 180 mm ERGO

2430 GC-200 IP SNIPE NOSE CUTTING CHROME 200

2427 GC-200IP LONG.ROUND NOSE CHROMED PL200

2900-180 CIRCLIP PLIER 2900-180

2890-180 CIRCLIP PLIER 2890-180

2990-180 CIRCLIP PLIER 2990-180

2800-180 CIRCLIP PLIER 2800-180

7224 SLIP JOINT PLIER 250 mm

2101GC-160IP SIDE CUTTER 2101GC-160

479-16 DIN HAMMER

3625N-35 PLASTIC HAMMER

1547 FEELER GAUGE

MTB-3-16 3M TAPE MEASURE 16 mm

SC127 ELECTRICIAN'S SCISSORS 5"130 mm

MIX

3/3 MODULE MIX COMPOSITION



ERGO TOOL MANAGEMENT SYSTEM



FF1A24 - 19 pcs

- 3735-4-120 PUNCH
- 3734-2 COTTER PIN PUNCH
- 3734-3 COTTER PIN PUNCH
- 3734-4 COTTER PIN PUNCH
- 3734-5 COTTER PIN PUNCH
- 3734-6 COTTER PIN PUNCH
- 3734-8 COTTER PIN PUNCH
- 2630GC-180IP COMBINATION PLIER 180 mm ERGO
- 2430 GC-200 IP SNIPE NOSE CUTTING CHROME 200
- 2900-180 CIRCLIP PLIER 2900-180
- 2890-180 CIRCLIP PLIER 2890-180
- 2990-180 CIRCLIP PLIER 2990-180
- 2800-180 CIRCLIP PLIER 2800-180
- 7224 SLIP JOINT PLIER 250 mm
- 2101GC-160IP SIDE CUTTER 2101GC-160
- 479-16 DIN HAMMER
- 3625N-35 PLASTIC HAMMER
- MTB-3-16 3M TAPE MEASURE 16 mm
- SC127 ELECTRICIAN'S SCISSORS 5" 130 mm



FF1A25 - 51 pcs

- 7800SM - 10, 12, 13, 14, 15, 16, 17, 18, 19, 21, 22, 23, 24, 27, 30, 32 SOCKET 1/2
- 7805SM-13, 16, 17, 18, 19, 21, 22, 24, 27, 30, 32, SOCKET DEEP 1/2
- 8154-1/2 T HANDLE
- 8159-1/2 EXTENSION
- 8160-1/2 EXTENSION
- 8166-1/2 UNIVERSAL JOINT
- 8150SL RATCHET 1/2, SLIM HEAD 72T
- 6700SM - 4, 4.5, 5, 5.5, 6, 7, 8, 9, 10, 11, 12, 13, SOCKET 1/4
- 6954 T-HANDLE
- 6960 EXTENSION 1/4 50 mm
- 6962 EXTENSION 1/4 150 mm
- 6966 UNIVERSAL JOINT
- 6950SL RATCHET 1/4, SLIM HEAD 72T
- 2953-250 UNIV.LOCKING CURVED PLIER 250

MIX

3/3 MODULE MIX COMPOSITION



ERGO TOOL MANAGEMENT SYSTEM



FF1A26 - 27 pcs

111M-6, 7, 8, 9, 10, 11, 12, 13, 14, 15, 16, 17, 18, 19, 20, 21, 22, 24, 27, 30, 32, COMBINATION WRENCH

2630GC-180IP COMBINATION PLIER 180 mm ERGO

2430 GC-200 IP SNIPE NOSE CUTTING CHROME 200

7224 SLIP JOINT PLIER 250 mm

2953-250 UNIV.LOCKING CURVED PLIER 250

2101GC-160IP SIDE CUTTER 2101GC-160

SC127 ELECTRICIAN'S SCISSORS 5"130 mm



FF1A27 -58 pcs

59S/31-1 BITS SET 31PCS PH,PZ,T,HEX,SL

BE-8257 SCREW.DR ERGO 1,6X8,0X175

BE-8255 SCREW.DR ERGO 1,2X6,5X150

BE-8242 SCREW.DR ERGO 1,0X5,5X150

BE-8040 SCREW.DR ERGO 0,8X4,0X100

BE-8030 SCREW.DR ERGO 0,6X3,5X75

BE-8611 SCREW.DR ERGO PH1X75

BE-8620 SCREW.DR ERGO PH2X100

BE-8910 SCREW.DR ERGO TX 10X75

BE-8915 SCREW.DR ERGO TX 15X100

BE-8920 SCREW.DR ERGO TX 20X100

BE-8925 SCREW.DR ERGO TX 25X125

BE-8927 SCREW.DR ERGO TX 27X125

BE-8930 SCREW.DR ERGO TX 30X150

BE-8940 SCREW.DR ERGO TX 40X150

BE-8577 SCREW.DR ERGO 1/4 BIT HOLDER

BE-8355 SCREW.DR ERGO 1,2X6,5X25

BE-8602 SCREW.DR ERGO PH2X25

BE-9678 SCREW.DR SET HEX BALL 9 PCS

BE-9575 SCREW.DR SET TORX 8PCS



FF1A28 - 48 pcs

7800SM-10, 12, 13, 14, 15, 16, 17, 18, 19, 21, 22, 23, 24, 27, 30, 32 SOCKET 1/2

8154-1/2 T HANDLE

8159-1/2 EXTENSION

8160-1/2 EXTENSION

8166-1/2 UNIVERSAL JOINT

8150SL RATCHET 1/2, SLIM HEAD 72T

6700SM-4, 4.5, 5, 5.5, 6, 7, 8, 9, 10, 11, 12, 13
SOCKET 1/4

6954 T-HANDLE

6960 EXTENSION 1/4 50MM

6962 EXTENSION 1/4 150MM

6966 UNIVERSAL JOINT

6950SL RATCHET 1/4, SLIM HEAD 72T

3735-4-120 PUNCH

3734-2 COTTER PIN PUNCH

3734-3 COTTER PIN PUNCH

3734-4 COTTER PIN PUNCH

3734-5 COTTER PIN PUNCH

3734-6 COTTER PIN PUNCH

3734-8 COTTER PIN PUNCH

479-16 DIN HAMMER

3625N-35 PLASTIC HAMMER

MTB-3-16 3M TAPE MEASURE 16MM

MIX

3/3 MODULE MIX COMPOSITION

- Double Ring end Wrenches
- Flex Head Wrenches
- Open Ring Wrenches



ERGO TOOL MANAGEMENT SYSTEM



FF1A5001 - 19 pcs

2430 G-200 IP SNIPE NOSE CUTTING 200 mm

2101G-160IP SIDE CUTTER 160 mm

2628 G-180IP COMB PLIER 180 mm

2951-180 GRIP WITH WIRE CUTTER 180 mm

7224 SLIP JOINT PLIER 250 mm

BE-8150 SCREW.DR ERGO 1,0 X 5,5 X 100

BE-8155 SCREW.DR ERGO 1,2 X 6,5 X 125

BE-8355 SCREW.DR ERGO 1,2 X 6,5 X 25

BE-8256 SCREW.DR ERGO 1,2 X 8,0 X 150

BE-8611 SCREW.DR ERGO PH1 X 75

BE-8602 SCREW.DR ERGO PH2 X 25

BE-8620 SCREW.DR ERGO PH2 X 100

BE-8910 SCREW.DR ERGO TX 10 X 65

BE-8915 SCREW.DR ERGO TX 15 X 70

BE-8920 SCREW.DR ERGO TX 20 X 80

BE-8925 SCREW.DR ERGO TX 25 X 80

BE-8930 SCREW.DR ERGO TX 30 X 100

BE-8940 SCREW.DR ERGO TX 40 X 130

BE-9770 SCREW.DR SET HEX 1,5-10



FF1A5002 - 27 pcs

111M-6 COMBINATION WRENCH

111M-7 COMBINATION WRENCH

111M-8 COMBINATION WRENCH

111M-9 COMBINATION WRENCH

111M-10 COMBINATION WRENCH

111M-11 COMBINATION WRENCH

111M-12 COMBINATION WRENCH

111M-13 COMBINATION WRENCH

111M-14 COMBINATION WRENCH

111M-15 COMBINATION WRENCH

111M-16 COMBINATION WRENCH

111M-17 COMBINATION WRENCH

111M-18 COMBINATION WRENCH

111M-19 COMBINATION WRENCH

111M-20 COMBINATION WRENCH

111M-21 COMBINATION WRENCH

111M-22 COMBINATION WRENCH

111M-24 COMBINATION WRENCH

111M-27 COMBINATION WRENCH

111M-30 COMBINATION WRENCH

111M-32 COMBINATION WRENCH

3734S/6 COMBINATION WRENCH



FF1A5003 - 91 pcs

111M-8 COMBINATION WRENCH

111M-10 COMBINATION WRENCH

111M-12 COMBINATION WRENCH

111M-13 COMBINATION WRENCH

111M-15 COMBINATION WRENCH

111M-17 COMBINATION WRENCH

111M-19 COMBINATION WRENCH

6700SM-5 SOCKET 1/4

6700SM-5.5 SOCKET 1/4

6700SM-6 SOCKET 1/4

6700SM-7 SOCKET 1/4

6700SM-8 SOCKET 1/4

6700SM-9 SOCKET 1/4

6700SM-10 SOCKET 1/4

6700SM-11 SOCKET 1/4

6700SM-12 SOCKET 1/4

6700SM-13 SOCKET 1/4

6700SM-14 SOCKET 1/4

6700TORX-E4 SOCKET 1/4

6700TORX-E5 SOCKET 1/4

MIX

3/3 MODULE MIX COMPOSITION



ERGO TOOL MANAGEMENT SYSTEM



FF1A5003 - 91 pcs

6700TORX-E6 SOCKET 1/4

6700TORX-E7 SOCKET 1/4

6700TORX-E8 SOCKET 1/4

6700TORX-E10 SOCKET 1/4

6709TORX-T8 SOCKET 1/4

6709TORX-T9 SOCKET 1/4

6709TORX-T10 SOCKET 1/4

6709TORX-T15 SOCKET 1/4

6709TORX-T20 SOCKET 1/4

6709TORX-T25 SOCKET 1/4

6709TORX-T27 SOCKET 1/4

6709TORX-T30 SOCKET 1/4

6709TORX-T40 SOCKET 1/4

6950 RATCHET 1/4

6961 EXTENSION

6962 EXTENSION

6966 UNIVERSAL JOINT

7400SM-8 SOCKET 3/8

7400SM-9 SOCKET 3/8

7400SM-10 SOCKET 3/8

7400SM-11 SOCKET 3/8

7400SM-12 SOCKET 3/8

7400SM-13 SOCKET 3/8

7400SM-14 SOCKET 3/8

7400SM-15 SOCKET 3/8

7400SM-16 SOCKET 3/8

7400SM-17 SOCKET 3/8

7400SM-18 SOCKET 3/8

7400SM-19 SOCKET 3/8

7400SM-21 SOCKET 3/8

7400SM-22 SOCKET 3/8

7400TORX-E8 SOCKET 3/8'

7400TORX-E10 SOCKET 3/8

7400TORX-E11 SOCKET 3/8

7400TORX-E12 SOCKET 3/8

7400TORX-E14 SOCKET 3/8

7400TORX-E16 SOCKET 3/8

7400TORX-E18 SOCKET 3/8

7409TORX-T25 SOCKET 3/8

7409TORX-T27 SOCKET 3/8

7409TORX-T30 SOCKET 3/8

7409TORX-T40 SOCKET 3/8

7409TORX-T45 SOCKET 3/8

7409TORX-T50 SOCKET 3/8

7750 RATCHET 3/8

7760 EXTENSION 3/8

7761 EXTENSION 3/8

7762 EXTENSION 3/8

7764 ADAPTOR 3/8

7765 ADAPTOR 3/8

7766 UNIVERSAL JOINT 3/8

8158-1/2 BREAKER BAR 3/8

A6800DM-6 SOCKET 1/4, LONG

A6800DM-7 SOCKET 1/4, LONG

A6800DM-8 SOCKET 1/4, LONG

A6800DM-9 SOCKET 1/4, LONG

A6800DM-10 SOCKET 1/4, LONG

A6800DM-11 SOCKET 1/4, LONG

A6800DM-12 SOCKET 1/4, LONG

A6800DM-13 SOCKET 1/4, LONG

A6800DM-14 SOCKET 1/4, LONG

A7402DM-10 SOCKET 3/8, LONG

A7402DM-11 SOCKET 3/8, LONG

A7402DM-12 SOCKET 3/8, LONG

A7402DM-13 SOCKET 3/8, LONG

A7402DM-14 SOCKET 3/8, LONG

A7402DM-15 SOCKET 3/8, LONG

A7402DM-16 SOCKET 3/8, LONG

A7402DM-17 SOCKET 3/8, LONG

A7402DM-18 SOCKET 3/8, LONG

A7402DM-19 SOCKET 3/8, LONG

MIX

3/3 MODULE MIX COMPOSITION



ERGO TOOL MANAGEMENT SYSTEM



FF1A3004 - 30 pcs

111M-6 COMBINATION WRENCH
 111M-7 COMBINATION WRENCH
 111M-8 COMBINATION WRENCH
 111M-9 COMBINATION WRENCH
 111M-10 COMBINATION WRENCH
 111M-11 COMBINATION WRENCH
 111M-12 COMBINATION WRENCH
 111M-13 COMBINATION WRENCH
 111M-14 COMBINATION WRENCH
 111M-15 COMBINATION WRENCH
 111M-16 COMBINATION WRENCH
 111M-17 COMBINATION WRENCH
 111M-18 COMBINATION WRENCH
 111M-19 COMBINATION WRENCH
 111M-20 COMBINATION WRENCH
 111M-21 COMBINATION WRENCH
 111M-22 COMBINATION WRENCH
 111M-24 COMBINATION WRENCH
 1RM-8 RATCHET WRENCH
 1RM-9 RATCHET WRENCH
 1RM-10 RATCHET WRENCH
 1RM-11 RATCHET WRENCH
 1RM-12 RATCHET WRENCH
 1RM-13 RATCHET WRENCH
 1RM-14 RATCHET WRENCH
 1RM-15 RATCHET WRENCH
 1RM-16 RATCHET WRENCH
 1RM-17 RATCHET WRENCH
 1RM-18 RATCHET WRENCH
 1RM-19 RATCHET WRENCH



FF1A5004 - 37 pcs

1RM-6 RATCHET WRENCH
 1RM-7 RATCHET WRENCH
 1RM-8 RATCHET WRENCH
 1RM-9 RATCHET WRENCH
 1RM-10 RATCHET WRENCH
 1RM-11 RATCHET WRENCH
 1RM-12 RATCHET WRENCH
 1RM-13 RATCHET WRENCH
 1RM-17 RATCHET WRENCH
 1RM-19 RATCHET WRENCH
 1RM-22 RATCHET WRENCH
 1RM-24 RATCHET WRENCH
 1RM-27 RATCHET WRENCH
 6700SM-10 SOCKET 1/4
 6700SM-11 SOCKET 1/4
 6700SM-12 SOCKET 1/4
 6700SM-13 SOCKET 1/4
 6700SM-6 SOCKET 1/4
 6700SM-7 SOCKET 1/4
 6700SM-8 SOCKET 1/4
 6700SM-9 SOCKET 1/4
 6950 RATCHET 1/4
 6960 EXTENSION 1/4
 6966 UNIVERSAL JOINT 1/4
 7800SM-13 SOCKET 1/2
 7800SM-17 SOCKET 1/2
 7800SM-19 SOCKET 1/2
 7800SM-22 SOCKET 1/2
 7800SM-22 SOCKET 1/2
 7800SM-24 SOCKET 1/2
 7800SM-27 SOCKET 1/2
 7800SM-30 SOCKET 1/2
 7800SM-32 SOCKET 1/2
 8155-1/2 ONE HANDLE RATCHET 1/2
 8160-1/2 EXTENSION
 8166-1/2 UNIVERSAL JOINT
 SBS64 BAHCO T-HANDLE 1/4
 SBS86 BAHCO SLIDING T-HANDLE 1/2

MIX

3/3 MODULE MIX COMPOSITION



ERGO TOOL MANAGEMENT SYSTEM



FF1A5005 - 83 pcs

111M-13 COMBINATION WRENCH

111M-15 COMBINATION WRENCH

111M-17 COMBINATION WRENCH

111M-19 COMBINATION WRENCH

111M-8 COMBINATION WRENCH

6700SM-10 SOCKET 1/4

6700SM-11 SOCKET 1/4

6700SM-12 SOCKET 1/4

6700SM-13 SOCKET 1/4

6700SM-14 SOCKET 1/4

6700SM-4 SOCKET 1/4

6700SM-5 SOCKET 1/4

6700SM-6 SOCKET 1/4

6700SM-7 SOCKET 1/4

6700SM-8 SOCKET 1/4

6700SM-9 SOCKET 1/4

6709M-3 SOCKET 1/4

6709M-4 SOCKET 1/4

6709M-5 SOCKET 1/4

6709M-6 SOCKET 1/4

6709M-8 SOCKET 1/4

6950SL RATCHET 1/4, SLIM HEAD 72T

6960-W WOBBLE EXTENSION 1/4 - 50 mm

6962 EXTENSION 1/4

6962-W WOBBLE EXTENSION 1/4 - 150 mm

6968 SMOOTH OPERATION U.JOINT-1/4

7400SM-10 SOCKET 3/8

7400SM-11 SOCKET 3/8

7400SM-12 SOCKET 3/8

7400SM-13 SOCKET 3/8

7400SM-14 SOCKET 3/8

7400SM-15 SOCKET 3/8

7400SM-16 SOCKET 3/8

7400SM-17 SOCKET 3/8

7400SM-18 SOCKET 3/8

7400SM-6 SOCKET 3/8

7400SM-7 SOCKET 3/8

7400SM-8 SOCKET 3/8

7400SM-9 SOCKET 3/8

7750SL RATCHET 3/8, SLIM HEAD 72T

7760-W WOBBLE EXTENSION 3/8-75 mm

7761 EXTENSION 3/8

7768 SMOOTH OPERATION U.JOINT-3/8

7800SM-10 SOCKET 1/2

7800SM-11 SOCKET 1/2

7800SM-12 SOCKET 1/2

7800SM-13 SOCKET 1/2

7800SM-14 SOCKET 1/2

7800SM-15 SOCKET 1/2

7800SM-16 SOCKET 1/2

7800SM-17 SOCKET 1/2

7800SM-18 SOCKET 1/2

7800SM-19 SOCKET 1/2

7800SM-21 SOCKET 1/2

7800SM-22 SOCKET 1/2

7800SM-24 SOCKET 1/2

7800SM-27 SOCKET 1/2

7800SM-30 SOCKET 1/2

7800SM-32 SOCKET 1/2

7800SM-8 SOCKET 1/2

7800SM-9 SOCKET 1/2

7809M-10 SOCKET 1/2

7809M-12 SOCKET 1/2

7809M-14 SOCKET 1/2

7809M-17 SOCKET 1/2

7809M-5 SOCKET 1/2

7809M-6 SOCKET 1/2

7809M-7 SOCKET 1/2

7809M-8 SOCKET 1/2

7809TORX-T20 SOCKET 1/2

7809TORX-T25 SOCKET 1/2

7809TORX-T30 SOCKET 1/2

7809TORX-T40 SOCKET 1/2

7809TORX-T45 SOCKET 1/2

8150SL RATCHET 1/2, SLIM HEAD 72T

8160-1/2 EXTENSION 1/2

8162-1/2 EXTENSION 1/2

8166-1/2 UNIVERSAL JOINT 1/2

A6709M-2.5 SOCKET 1/4, LONG

A6709M-3 SOCKET 1/4, LONG

A6709M-4 SOCKET 1/4, LONG

A6709M-5 SOCKET 1/4, LONG

A6709M-6 SOCKET 1/4, LONG

MIX

3/3 MODULE MIX COMPOSITION



ERGO TOOL MANAGEMENT SYSTEM



FF1A5006 - 27 pcs

1-100-08-2-2 8" HAND, WITH HANDLE.CUT 2

1-210-08-2-2 8" 1/2 ROUND, WITH HANDLE.CUT 2

1-230-06-2-2 6" ROUND, WITH HANDLE.CUT 2

1-230-10-2-2 10" ROUND, WITH HANDLE.CUT 2

111M-7 COMBINATION WRENCH

111M-8 COMBINATION WRENCH

111M-9 COMBINATION WRENCH

111M-10 COMBINATION WRENCH

111M-11 COMBINATION WRENCH

111M-12 COMBINATION WRENCH

111M-13 COMBINATION WRENCH

111M-14 COMBINATION WRENCH

111M-15 COMBINATION WRENCH

111M-16 COMBINATION WRENCH

111M-17 COMBINATION WRENCH

111M-18 COMBINATION WRENCH

111M-19 COMBINATION WRENCH

111M-21 COMBINATION WRENCH

111M-22 COMBINATION WRENCH

1320RM-6-7 RATCHET WRENCH DOUBLE FLAT

1320RM-8-9 RATCHET WRENCH DOUBLE FLAT

1320RM-10-11 RATCHET WRENCH DOUBLE FLAT

1320RM-12-13 RATCHET WRENCH DOUBLE FLAT

1320RM-14-15 RATCHET WRENCH DOUBLE FLAT

1320RM-16-17 RATCHET WRENCH DOUBLE FLAT

1320RM-18-19 RATCHET WRENCH DOUBLE FLAT

1320RM-22-24 RATCHET WRENCH DOUBLE FLAT

■ MIX

3/3 MODULE MIX COMPOSITION



ERGO TOOL MANAGEMENT SYSTEM

**FF1A5007 - 60 pcs**

K6650-1/4 ADAPTOR 1/4" 50 mm 1/4 W/PIN

3734-2 COTTER PIN PUNCH

3734-3 COTTER PIN PUNCH

3734-4 COTTER PIN PUNCH

3734-5 COTTER PIN PUNCH

3734-6 COTTER PIN PUNCH

3734-8 COTTER PIN PUNCH

481-400 GERMAN DIN-HAMMER

6700SM-10 SOCKET 1/4

6700SM-11 SOCKET 1/4

6700SM-12 SOCKET 1/4

6700SM-13 SOCKET 1/4

6700SM-14 SOCKET 1/4

6700SM-4 SOCKET 1/4

6700SM-5 SOCKET 1/4

6700SM-6 SOCKET 1/4

6700SM-7 SOCKET 1/4

6700SM-8 SOCKET 1/4

6700SM-9 SOCKET 1/4

6709F-5.5 SOCKET 1/4

6709F-8 SOCKET 1/4

6709M-3 SOCKET 1/4

6709M-4 SOCKET 1/4

6709M-5 SOCKET 1/4

6709M-6 SOCKET 1/4

6709PH-1 SOCKET 1/4

6709PH-2 SOCKET 1/4

6950SL RATCHET 1/4, SLIM HEAD 72T

6954 T-HANDLE 1/4

6960 EXTENSION 1/4

6962 EXTENSION 1/4

6966 UNIVERSAL JOINT 1/4

7800SM-10 SOCKET 1/2

7800SM-11 SOCKET 1/2

7800SM-12 SOCKET 1/2

7800SM-13 SOCKET 1/2

7800SM-14 SOCKET 1/2

7800SM-15 SOCKET 1/2

7800SM-16 SOCKET 1/2

7800SM-17 SOCKET 1/2

7800SM-18 SOCKET 1/2

7800SM-19 SOCKET 1/2

7800SM-21 SOCKET 1/2

7800SM-22 SOCKET 1/2

7800SM-23 SOCKET 1/2

7800SM-24 SOCKET 1/2

7800SM-25 SOCKET 1/2

7800SM-26 SOCKET 1/2

7800SM-27 SOCKET 1/2

7800SM-28 SOCKET 1/2

7800SM-30 SOCKET 1/2

7800SM-32 SOCKET 1/2

8072IP ADJUSTABLE WRENCH 10

814-100 AWL

8150SL RATCHET 1/2, SLIM HEAD 72T

8154-1/2 T-HANDLE 1/2

8160-1/2 EXTENSION 1/2

8162-1/2 EXTENSION 1/2

8166-1/2 UNIVERSAL JOINT 1/2

8224IP SLIP JOINT PLIER 250 mm

MIX

3/3 MODULE MIX COMPOSITION



ERGO TOOL MANAGEMENT SYSTEM



FF1A5008 - 24 pcs

1-100-08-2-2 8 HAND, WITH HANDLE, CUT 2

1-160-08-2-2 8 SQUARE, WITH HANDLE, CUT 2

1-170-08-2-2 8 3 SQUARE, WITH HANDLE, CUT 2

1-210-08-2-2 8 1/2 ROUND, WITH HANDLE, CUT 2

1-230-08-2-2 8 ROUND, WITH HANDLE, CUT 2

1150D CALIPER, DIGITAL

1450D-ISO DOUBLE THREAD RESTORER

1547 FEELER GAUGE

3625N-40 PLASTIC HAMMER

3734-2 COTTER PIN PUNCH

3734-3 COTTER PIN PUNCH

3734-4 COTTER PIN PUNCH

3734-5 COTTER PIN PUNCH

3734-6 COTTER PIN PUNCH

3734-8 COTTER PIN PUNCH

3735-4-120 CENTRE PUNCH

3735-5-150 CENTRE PUNCH

3740-125 FLAT CHISEL

3740-150 FLAT CHISEL

38-20 TYRE LEVER

5515T TELESCOPIC MIRROR

9029 ADJUSTABLE WRENCH

9031 ADJUSTABLE WRENCH

MTB-3-16 3M TAPE MEASURE 16 mm



FF1A5009 - 17 pcs

2101S-160 SIDE CUTTER 160 mm

2223S-150 STRIPPING PLIER 150 mm

2250V-170 CABLE CUTTER 1000V 8D

2430S-200 LONG NOSE PLIER 200 mm

2628S-180 COMB PLIER 180 mm

8072V ADJUSTABLE WRENCH 1000V 10"

BE-8220S SCREW.DR ERGO IEC 0.5 X 3.0 X 100

BE-8040S SCREW.DR ERGO IEC 0.8 X 4.0 X 100

BE-8340 SCREW.DR ERGO 0.8 X 4 X 25

BE-8050S SCREW.DR ERGO IEC 1.0 X 5.5 X 125

BE-8255S SCREW.DR ERGO IEC 1.2 X 6.5 X 150

BE-8065S SCREW.DR ERGO IEC 1.2 X 8.0 X 175

BE-8601 SCREW.DR ERGO PH1 X 25

BE-8610S SCREW.DR ERGO IEC PH1 X 75

BE-8620S SCREW.DR ERGO IEC PH2 X 100

BE-8810S SCREW.DR ERGO IEC PZ1 X 75

BE-8820S SCREW.DR ERGO IEC PZ2 X 100



FF1A5010 - 22 pcs

1-100-08-1-2 8" HAND, WITH HANDLE, CUT 1

1-160-08-1-2 8" SQUARE, WITH HANDLE, CUT 1

1-170-08-2-2 8" 3 SQUARE, WITH HANDLE, CUT 2

1-210-08-1-2 8" 1/2 ROUND, WITH HANDLE, CUT 1

1-230-08-1-2 8" ROUND, WITH HANDLE, CUT 1

2101G-180IP SIDE CUTTER 180 mm

2427G-200IP SNIPE NOSE BENT G 200 mm

2430G-200IP SNIPE NOSE CUTTING 200 mm

2628G-180IP COMB PLIER 180 mm

3733-2 DRIFT PUNCH

3733-4 DRIFT PUNCH

3733-6 DRIFT PUNCH

3734-2 COTTER PIN PUNCH

3734-3 COTTER PIN PUNCH

3734-4 COTTER PIN PUNCH

3734-5 COTTER PIN PUNCH

3734-6 COTTER PIN PUNCH

3734-8 COTTER PIN PUNCH

3735-4-120 CENTRE PUNCH

481-300 GERMAN DIN-HAMMER

8069IP ADJUSTABLE WRENCH 4"

9031 ADJUSTABLE WRENCH

MIX

3/3 MODULE MIX COMPOSITION



ERGO TOOL MANAGEMENT SYSTEM



FF1A5011 - 22 pcs

1-476-04-3-2 SET 4" KEY FILES WITH HANDLES

1178-SCRIBE SCRIBER CARG.TUNGSTEN

1547 FEELER GAUGE

2101G-160IP SIDE CUTTER 160 mm

2427G-160IP SNIPE NOSE BENT 160 mm

2430G-160IP SNIPE NOSE CUTTING 160 mm

3734-2 COTTER PIN PUNCH

3734-3 COTTER PIN PUNCH

3734-4 COTTER PIN PUNCH

3734-5 COTTER PIN PUNCH

3734-6 COTTER PIN PUNCH

3734-8 COTTER PIN PUNCH

3735-5-120 CENTRE PUNCH

481-500 GERMAN DIN-HAMMER

BE-8020L SCREW.DR ERGO 0,5 X 3 X 75

BE-8040 SCREW.DR ERGO 0,8 X 4,0 X 100

BE-8150 SCREW.DR ERGO 1,0 X 5,5 X 100

BE-8255 SCREW.DR ERGO 1,2 X 6,5 X 150

BE-8256 SCREW.DR ERGO 1,2 X 8,0 X 150

BE-8610 SCREW.DR ERGO PH1 X 75

BE-8620 SCREW.DR ERGO PH2 X 100

MTB-3-16 3 m TAPE MEASURE 16 mm



FF1A5012 - 13 pcs

141 PIPE WRENCH

319 HACKSAW FRAME

3734-2 COTTER PIN PUNCH

3734-3 COTTER PIN PUNCH

3734-4 COTTER PIN PUNCH

3734-5 COTTER PIN PUNCH

3734-6 COTTER PIN PUNCH

479-08 BALL PEIN HAMMER

481-1000 GERMAN DIN-HAMMER

481-300 GERMAN DIN-HAMMER

782-U UTILITY WIRE BRUSH

MTS-5-25 5 m TAPE 25 mm STAINLESS

SQZ150003 UNIVERSAL KNIFE

MIX

3/3 MODULE MIX COMPOSITION



ERGO TOOL MANAGEMENT SYSTEM



FF1A5013- 41 pcs

111M-6 COMBINATION WRENCH

111M-7 COMBINATION WRENCH

111M-8 COMBINATION WRENCH

111M-9 COMBINATION WRENCH

111M-10 COMBINATION WRENCH

111M-11 COMBINATION WRENCH

111M-12 COMBINATION WRENCH

111M-13 COMBINATION WRENCH

111M-17 COMBINATION WRENCH

111M-19 COMBINATION WRENCH

111M-20 COMBINATION WRENCH

111M-22 COMBINATION WRENCH

111M-24 COMBINATION WRENCH

111M-27 COMBINATION WRENCH

111M-30 COMBINATION WRENCH

111M-32 COMBINATION WRENCH

6700SM-6 SOCKET 1/4

6700SM-7 SOCKET 1/4

6700SM-8 SOCKET 1/4

6700SM-9 SOCKET 1/4

6700SM-10 SOCKET 1/4

6700SM-11 SOCKET 1/4

6700SM-12 SOCKET 1/4

6700SM-13 SOCKET 1/4

6700SM-14 SOCKET 1/4

6950 RATCHET 1/4

6960 EXTENSION

6966 UNIVERSAL JOINT

7800SM-13 SOCKET 1/2

7800SM-17 SOCKET 1/2

7800SM-19 SOCKET 1/2

7800SM-22 SOCKET 1/2

7800SM-24 SOCKET 1/2

7800SM-27 SOCKET 1/2

7800SM-30 SOCKET 1/2

7800SM-32 SOCKET 1/2

8155-1/2 ONE HANDLE RATCHET 1/2"

8160-1/2 EXTENSION

8166-1/2 UNIVERSAL JOINT

SBS64 BAHCO T-HANDLE 1/4"

SBS86 BAHCO SLIDING T-HANDLE 1/2"

■ SCREWDRIVERS

3/3 MODULE SCREWDRIVERS COMPOSITION

- Slotted and Phillips
- Slotted, Phillips and Pozidriv
- Slotted, Phillips and Torx



ERGO TOOL MANAGEMENT SYSTEM



FF1A1001 - 14 pcs

2509 FLEX. PICK UP

2535F1 MAGNETIC PICK UP

BE-8040 SCREW.DR ERGO 0,8 X 4,0 X 100

BE-8210 SCREW.DR ERGO 0,4 X 2,5 X 75

BE-8230 SCREW.DR ERGO 0,6 X 3,5 X 125

BE-8252 SCREW.DR ERGO 1,2 X 6,5 X 150

BE-8255 SCREW.DR ERGO 1,2 X 6,5 X 150

BE-8350 SCREW.DR ERGO 1 X 5,5 X 25

BE-8628 SCREW.DR ERGO PH1 X 100

BE-8602 SCREW.DR ERGO PH2 X 25

BE-8610L SCREW.DR ERGO PH1 X 200

BE-8620L SCREW.DR ERGO PH2 X 200

BE-8629 SCREW.DR ERGO PH2 X 125

BE-8630 SCREW.DR ERGO PH3 X 150



FF1A1002 - 27 pcs

BE-8010S SCREW.DR ERGO IEC 0,4 X 2,5 X 75

BE-8030 SCREW.DR ERGO 0,6 X 3,5 X 75

BE-8040 SCREW.DR ERGO 0,8 X 4,0 X 100

BE-8350 SCREW.DR ERGO 1 X 5,5 X 25

BE-8242 SCREW.DR ERGO 1,0 X 5,5 X 150

BE-8252 SCREW.DR ERGO 1,2 X 6,5 X 150

BE-8257 SCREW.DR ERGO 1,2 X 8,0 X 175

BE-8258 SCREW.DR ERGO 1,6 X 10,0 X 200

BE-8880 SCREW.DR ERGO 2,0 X 12,0 X 200

BE-8602 SCREW.DR ERGO PH2 X 25

BE-8610 SCREW.DR ERGO PH1 X 75

BE-8620 SCREW.DR ERGO PH2 X 100

BE-8630 SCREW.DR ERGO PH3 X 150

BE-8640 SCREW.DR ERGO PH4 X 200

BE-8800 SCREW.DR ERGO PZ0 X 60

BE-8802 SCREW.DR ERGO PZ2 X 25

BE-8810 SCREW.DR ERGO PZ1 X 75

BE-8820 SCREW.DR ERGO PZ2 X 100

BE-9578 SCREW.DR SET HEX BLACK 9 PCS



FF1A1003 - 27 pcs

BE-8158 SCREW.DR ERGO 1,0 X 5,5 X 125

BE-8159 SCREW.DR ERGO 1,2 X 6,5 X 150

BE-8350 SCREW.DR ERGO 1 X 5,5 X 25

BE-8870 SCREW.DR ERGO 1,6 X 10,0 X 175

BE-8880 SCREW.DR ERGO 2,0 X 12,0 X 200

BE-8610 SCREW.DR ERGO PH1 X 75

BE-8602 SCREW.DR ERGO PH2X25

BE-8630 SCREW.DR ERGO PH3 X 150

BE-8908 SCREW.DR ERGO TX 8 X 60

BE-8909 SCREW.DR ERGO TX 9 X 60

BE-8910 SCREW.DR ERGO TX 10 X 65

BE-8915 SCREW.DR ERGO TX 15 X 70

BE-8920 SCREW.DR ERGO TX 20 X 80

BE-8925 SCREW.DR ERGO TX 25 X 80

BE-8927 SCREW.DR ERGO TX 27 X 100

BE-8930 SCREW.DR ERGO TX 30 X 100

BE-8940 SCREW.DR ERGO TX 40 X 130

BE-9575 SCREW.DR SET TORX 8PCS

BE-9578 SCREW.DR SET HEX BLACK 9 PCS

■ SCREWDRIVERS

3/3 MODULE SCREWDRIVERS COMPOSITION

- T Handle
- Slotted ,Phillips, Pozidriv and Torx
- Slotted,Phillips and Torx and Nut Drivers



ERGO TOOL MANAGEMENT SYSTEM



FF1A1004 - 19 pcs

900T-050-150 HEXAGONAL T-HANDLE 5 X 150

900T-020-100 HEXAGONAL T-HANDLE 2 X 100

900T-025-100 HEXAGONAL T-HANDLE 2.5 X 100

900T-030-100 HEXAGONAL T-HANDLE 3 X 100

900T-040-150 HEXAGONAL T-HANDLE 4 X 150

900T-060-200 HEXAGONAL T-HANDLE 6 X 200

900T-080-200 HEXAGONAL T-HANDLE 8 X 200

900T-100-200 HEXAGONAL T-HANDLE 10 X 200

BE-9777B HEX KEY FOLDER HEX 2,5-10 BIMAT



FF1A1005 - 66 pcs

59S/31-1 BITS SET 31PCS PH,PZ,T,HEX,SL

BE-8020 SCREW.DR ERGO 0,5 X 3,0 X 60

BE-8240 SCREW.DR ERGO 0,8 X 4,0 X 175

BE-8250 SCREW.DR ERGO 1,0 X 5,5 X 150

BE-8255 SCREW.DR ERGO 1,2 X 6,5 X 150

BE-8865 SCREW.DR ERGO 1,6 X 8,0 X 175

BE-8602 SCREW.DR ERGO PH2 X 25

BE-8611 SCREW.DR ERGO PH1 X 75

BE-8621 SCREW.DR ERGO PH2 X 100

BE-8630 SCREW.DR ERGO PH3 X 150

BE-8800 SCREW.DR ERGO PZ0 X 60

BE-8802 SCREW.DR ERGO PZ2 X 25

BE-8811 SCREW.DR ERGO PZ1 X 75

BE-8821 SCREW.DR ERGO PZ2 X 100

BE-8830 SCREW.DR ERGO PZ3 X 150

BE-8910 SCREW.DR ERGO TX 10 X 65

BE-8915 SCREW.DR ERGO TX 15 X 70

BE-8920 SCREW.DR ERGO TX 20 X 80

BE-8925 SCREW.DR ERGO TX 25 X 80

BE-9585 SCREW.DR SET TORX+MAG 8PCS

BE-9678 SCREW.DR SET HEX BALL 9 PCS



FF1A1006 - 29 pcs

BE-7606 NUT DRIVER ERGO

BE-7607 NUT DRIVER ERGO

BE-8030 SCREW.DR ERGO 0,6 X 3,5 X 75

BE-8040 SCREW.DR ERGO 0,8 X 4,0 X 100

BE-8155 SCREW.DR ERGO 1,2 X 6,5 X 125

BE-8350 SCREW.DR ERGO 1 X 5,5 X 25

BE-8602 SCREW.DR ERGO PH2 X 25

BE-8611 SCREW.DR ERGO PH1 X 75

BE-8621 SCREW.DR ERGO PH2 X 100

BE-8630 SCREW.DR ERGO PH3 X 150

BE-8906 SCREW.DR ERGO TX 6 X 50

BE-8907 SCREW.DR ERGO TX 7 X 55

BE-8908 SCREW.DR ERGO TX 8 X 60

BE-8909 SCREW.DR ERGO TX 9 X 60

BE-8910 SCREW.DR ERGO TX 10 X 65

BE-8915 SCREW.DR ERGO TX 15 X 70

BE-8920 SCREW.DR ERGO TX 20 X 80

BE-8925 SCREW.DR ERGO TX 25 X 80

BE-8930 SCREW.DR ERGO TX 30 X 100

BE-8940 SCREW.DR ERGO TX 40 X 130

BE-9688 SCREW.DR SET HEX BALL +MAG 9PCS

■ SCREWDRIVERS

3/3 MODULE SCREWDRIVERS COMPOSITION

- Slotted, Phillips and Torx and Nut Drivers



ERGO TOOL MANAGEMENT SYSTEM



FF1A1007 - 63 pcs

2510 WORKSHOP MIRROR

5468-112 TWEEZER 5468-112

5471F-145 TWEEZER 5471 F-145

59/S31 IMPACT BITS SET 31PCS

BE-8040 SCREW.DR ERGO 0,8 X 4,0 X 100

BE-8158 SCREW.DR ERGO 1,0 X 5,5 X 125

BE-8159 SCREW.DR ERGO 1,2 X 6,5 X 150

BE-8220 SCREW.DR ERGO 0,5 X 3,0 X 125

BE-8340 SCREW.DR ERGO 0,8 X 4 X 25

BE-8601 SCREW.DR ERGO PH1 X 25

BE-8628 SCREW.DR ERGO PH1 X 100

BE-8629 SCREW.DR ERGO PH2 X 125

BE-8865 SCREW.DR ERGO 1,6 X 8,0 X 175

BE-8906 SCREW.DR ERGO TX 6 X 50

BE-8907 SCREW.DR ERGO TX 7 X 55

BE-8908 SCREW.DR ERGO TX 8 X 60

BE-8909 SCREW.DR ERGO TX 9 X 60

BE-8910 SCREW.DR ERGO TX 10 X 65

BE-8915 SCREW.DR ERGO TX 15 X 70

BE-8920 SCREW.DR ERGO TX 20 X 80

BE-8925 SCREW.DR ERGO TX 25 X 80

BE-8930 SCREW.DR ERGO TX 30 X 100

BE-9770 SCREW.DR SET HEX 1,5-10

TL124-SA TWEEZER 124-SA

■ SOCKETS

3/3 MODULE SOCKETS AND ACCESSORIES COMPOSITION

- 3/4 sockets and accessories



ERGO TOOL MANAGEMENT SYSTEM



FF1A2301 - 26 pcs

8900DM-19 SOCKET 3/4

8900DM-22 SOCKET 3/4

8900DM-23 SOCKET 3/4

8900DM-24 SOCKET 3/4

8900DM-25 SOCKET 3/4

8900DM-26 SOCKET 3/4

8900DM-27 SOCKET 3/4

8900DM-28 SOCKET 3/4

8900DM-29 SOCKET 3/4

8900DM-30 SOCKET 3/4

8900DM-32 SOCKET 3/4

8900DM-33 SOCKET 3/4

8900DM-34 SOCKET 3/4

8900DM-36 SOCKET 3/4

8900DM-41 SOCKET 3/4

8900DM-46 SOCKET 3/4

8900DM-50 SOCKET 3/4

8900DM-55 SOCKET 3/4

8900DM-60 SOCKET 3/4

8952N/B HANDLE 3/4

8954 T-HANDLE 3/4

8954A SLIDING HEAD 3/4

8958A BREAKER BAR HEAD 3/4

8961 EXTENSION 3/4

8965 ADAPTOR 3/4

8966 UNIVERSAL JOINT 3/4

SOCKETS

3/3 MODULE SOCKETS AND ACCESSORIES COMPOSITION

▪ 1/4, 1/2, 3/8 sockets and accessories



ERGO TOOL MANAGEMENT SYSTEM



FF1A2501 - 83 pcs

6700SM-4 SOCKET 1/4

6700SM-5 SOCKET 1/4

6700SM-5.5 SOCKET 1/4

6700SM-6 SOCKET 1/4

6700SM-7 SOCKET 1/4

6700SM-8 SOCKET 1/4

6700SM-9 SOCKET 1/4

6700SM-10 SOCKET 1/4

6700SM-11 SOCKET 1/4

6700SM-12 SOCKET 1/4

6700SM-13 SOCKET 1/4

6700TORX-E8 SOCKET 1/4

6700TORX-E10 SOCKET 1/4

6709M-3 SOCKET 1/4

6709M-4 SOCKET 1/4

6709M-5 SOCKET 1/4

6709M-6 SOCKET 1/4

6709M-8 SOCKET 1/4

6709TORX-T8 SOCKET 1/4

6709TORX-T10 SOCKET 1/4

6709TORX-T15 SOCKET 1/4

6709TORX-T20 SOCKET 1/4

6709TORX-T25 SOCKET 1/4

6709TORX-T27 SOCKET 1/4

6709TORX-T30 SOCKET 1/4

6709TORX-T40 SOCKET 1/4

6950SL RATCHET 1/4, SLIM HEAD 72T

6954 T-HANDLE 1/4

6956 NUT DRIVER 1/4

6962 EXTENSION 1/4

6966 UNIVERSAL JOINT 1/4

7400SM-8 SOCKET 3/8

7400SM-9 SOCKET 3/8

7400SM-10 SOCKET 3/8

7400SM-11 SOCKET 3/8

7400SM-12 SOCKET 3/8

7400SM-13 SOCKET 3/8

7400SM-14 SOCKET 3/8

7400SM-15 SOCKET 3/8

7400SM-16 SOCKET 3/8

7400SM-17 SOCKET 3/8

7400SM-18 SOCKET 3/8

7400SM-19 SOCKET 3/8

7400SM-20 SOCKET 3/8

7400SM-21 SOCKET 3/8

7400SM-22 SOCKET 3/8

7400TORX-E8 SOCKET 3/8

7400TORX-E10 SOCKET 3/8

7400TORX-E12 SOCKET 3/8

7400TORX-E14 SOCKET 3/8

7750SL RATCHET 3/8, SLIM HEAD 72T

7754 T-HANDLE 3/8

7762 EXTENSION 3/8

7764 ADAPTOR 3/8

7765 ADAPTOR 3/8

7766 UNIVERSAL JOINT

7768 SMOOTH OPERATION U.JOINT- 3/8

7800SM-12 SOCKET 1/2

7800SM-13 SOCKET 1/2

7800SM-17 SOCKET 1/2

7800SM-18 SOCKET 1/2

7800SM-19 SOCKET 1/2

7800SM-20 SOCKET 1/2

7800SM-21 SOCKET 1/2

7800SM-22 SOCKET 1/2

7800SM-24 SOCKET 1/2

7800SM-27 SOCKET 1/2

7800SM-30 SOCKET 1/2

7800SM-32 SOCKET 1/2

7809M-10 SOCKET 1/2

7809M-12 SOCKET 1/2

7809TORX-T20 SOCKET 1/2

7809TORX-T25 SOCKET 1/2

7809TORX-T40 SOCKET 1/2

7809TORX-T50 SOCKET 1/2

7809TORX-T55 SOCKET 1/2

8150SL RATCHET 1/2, SLIM HEAD 72T

8154-1/2 T-HANDLE 1/2

8162-1/2 EXTENSION 1/2

8164-1/2 ADAPTOR 1/2

8165-1/2 ADAPTOR 1/2

8166-1/2 UNIVERSAL JOINT 1/2

8964 ADAPTOR 1/2

■ WRENCHES

3/3 MODULE WRENCHES COMPOSITION

- Offset Combination and Ratcheting Wrenches



ERGO TOOL MANAGEMENT SYSTEM



FF1A3005 - 28 pcs

1952M-6 COMBINATION WRENCH

1952M-7 COMBINATION WRENCH

1952M-8 COMBINATION WRENCH

1952M-9 COMBINATION WRENCH

1952M-10 COMBINATION WRENCH

1952M-11 COMBINATION WRENCH

1952M-12 COMBINATION WRENCH

1952M-13 COMBINATION WRENCH

1952M-14 COMBINATION WRENCH

1952M-15 COMBINATION WRENCH

1952M-16 COMBINATION WRENCH

1952M-17 COMBINATION WRENCH

1952M-18 COMBINATION WRENCH

1952M-19 COMBINATION WRENCH

1952M-22 COMBINATION WRENCH

1RM-6 RATCHET WRENCH

1RM-7 RATCHET WRENCH

1RM-8 RATCHET WRENCH

1RM-9 RATCHET WRENCH

1RM-10 RATCHET WRENCH

1RM-11 RATCHET WRENCH

1RM-12 RATCHET WRENCH

1RM-13 RATCHET WRENCH

1RM-14 RATCHET WRENCH

1RM-17 RATCHET WRENCH

1RM-19 RATCHET WRENCH

1RM-22 RATCHET WRENCH

1RM-24 RATCHET WRENCH

PLIERS

3/3 MODULE WRENCHES COMPOSITION

- Pliers Mix including:
 - Side Cutting Pliers
 - Slip Joint Pliers
 - Circlip Pliers
 - Snipe Nose Pliers
 - Combination Pliers



ERGO TOOL MANAGEMENT SYSTEM



FF1A4001 - 12 pcs

1520D POWER CUTTER 1520 D

2101G-160IP SIDE CUTTER 160 mm

21HDG-200IP ERGO SIDE CUTTERHD 200 mm

2223G-150 STRIPPING PLIERS ERGO 150 mm

2421G-140IP FLAT NOSE PL LONG 140 mm

2421G-180IP FLAT NOSE PL 180 mm

2427G-200IP SNIPE NOSE BENT G 200 mm

2628G-180IP COMB PLIER 180 mm

2681 RIVET GUN

2951-140 CURVED JAWS CLAMP 140 mm

2951-300 GRIP WITH WIRE CUTTER 300 mm

8224IP SLIP JOINT PLIER 250 mm



FF1A4002 - 11 pcs

2101G-160IP SIDE CUTTER 160 mm

2430G-200IP SNIPE NOSE CUTTING 200 mm

2465D-200 CIRCLIPS PLIER 180 mm SPECIAL

2510 WORKSHOP MIRROR

2628G-160IP COMB PLIER 160 mm

2744 MULTI-PURPOSE SNIPE

2951-140 CURVED JAWS CLAMP 140 mm

2952-165 GRIP WITH EXTRA LONG NOSE

4560-210 LEVER SIDE CUTTING PLIERS 210 mm

527D-160 END CUTTER 160 mm

7224 SLIP JOINT PLIER 250 mm

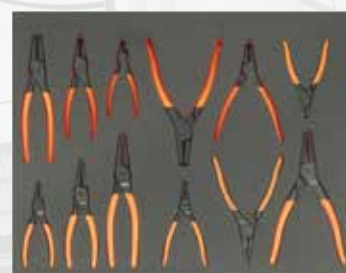

FF1A4003 - 12 pcs

2800-150 CIRCLIP PLIER 150 mm

2800-180 CIRCLIP PLIER 180 mm

2800-225 CIRCLIP PLIER 225 mm

2890-140 CIRCLIP PLIER 140 mm

2890-180 CIRCLIP PLIER 180 mm

2890-210 CIRCLIP PLIER 210 mm

2900-150 CIRCLIP PLIER 150 mm

2900-180 CIRCLIP PLIER 180 mm

2900-215 CIRCLIP PLIER 215 mm

2990-140 CIRCLIP PLIER 140 mm

2990-180 CIRCLIP PLIER 180 mm

2990-200 CIRCLIP PLIER 200 mm

GENERAL PURPOSE SMALL

■ 1470K5FFMINI

GENERAL PURPOSE COMPOSITION WITH 5 DRAWER TROLLEY

- General Purpose Small composition in a 1470K5 trolley:
 - 1/2 socket drivers
 - Combination wrenches
 - Slotted, PH and TORX screwdrivers
 - Bits covering all profiles
 - Pliers: Side Cutters, combination, snipe nose, etc.
- Suitable for most of the applications
- It comes with 1470K5 trolley
- References for those foams are: FF1A5019 and FF1A1008



GENERAL PURPOSE SMALL - 105 pcs

111M COMBINATION WRENCH 6, 7, 8, 9, 10, 11, 12, 13, 14, 15, 16, 17, 18, 19, 20 mm

2101G-160IP SIDE CUTTER 160 mm

2430 G-160 IP SNIPE NOSE CUTTING 160 mm

2628 G-180IP COMBINATION PLIER 160 mm

59S/31-1 PZ1, PZ2 (x3), PZ3; PH1, PH2 (x3), PH3; PH2G (x2); T10, T15 (x3), T20 (x3), T25 (x2), T27 and T30. SL: 3, 4,5, 5,5mm; HEX: 3mm, 4, 5, 6mm. 1/4 " Magnetic bit holder

7800DM SOCKET 1/2 8, 9, 10, 11, 12, 13, 14, 15, 16, 17, 18, 19, 20, 21, 22, 23, 24, 25, 26, 27, 28, 30, 32 mm

808050 RATCHETING BIT SCREWDRIVER

8154-1/2 T HANDLE 1/2

8155-1/2 RATCHET 1/2

8160-1/2 EXTENSION 125 mm

8162-1/2 EXTENSION 250 mm

8166-1/2 UNIVERSAL JOINT 1/2

8224 IP SLIP JOINT PLIER 250 mm

BE-8020L SCREWDRIVER ERGO 0,5 X 3 X 75

BE-8040 SCREWDRIVER ERGO 0,8 X 4,0 X 100

BE-8150 SCREWDRIVER ERGO 1,0 X 5,5 X 100

BE-8255 SCREWDRIVER ERGO 1,2 X 6,5 X 150

BE-8256 SCREWDRIVER ERGO 1,6 X 8,0 X 150

BE-8340 SCREWDRIVER ERGO 0,8 X 4 X 25

BE-8601 SCREWDRIVER ERGO PH1 X 25

BE-8610 SCREWDRIVER ERGO PH1 X 75

BE-8620 SCREWDRIVER ERGO PH2 X 100

BE-8925 SCREWDRIVER ERGO TORX 25 X 125

BE-8927 SCREWDRIVER ERGO TORX 27 X 125

BE-8930 SCREWDRIVER ERGO TORX 30 X 150

BE-8940 SCREWDRIVER ERGO TORX 40 X 150

BE-8945 SCREWDRIVER ERGO TORX 45 X 150

BE-9678 BLACK KEYS SETS FOR HEX SCREWS, LONG BALL END 1,5, 2, 2,5, 3, 4, 5, 6, 8, 10

GENERAL PURPOSE MEDIUM

■ 1470K6FFMEDIUM

GENERAL PURPOSE COMPOSITION WITH 6 DRAWER TROLLEY

- General Purpose Medium composition in a 1470K6 trolley:
 - 1/4 and 1/2 socket drivers
 - Combination wrenches
 - Slotted, PH and TORX screwdrivers
 - Bits covering all profiles
 - Pliers: Side Cutters, combination, snipe nose, slip joint pliers, etc.
 - Including adjustable, T handle, hammers, hand hacksaws and its frame
- Suitable for most of the applications
- It comes with 1470K6 trolley
- References for those foams are: FF1A5020, FF1A5021, FF1A5022 and FF1A1009



ERGO TOOL MANAGEMENT SYSTEM



GENERAL PURPOSE MEDIUM - 144 pcs

111M COMBINATION WRENCH: 6, 7, 8, 9, 10, 11, 12, 13, 14, 15, 16, 17, 18, 19, 20 mm

141 PIPE WRENCH

1419-MD MAGNETIC DISH

208-3906 HACKSAW FRAMES

2101G-160IP SIDE CUTTER 160 mm

2430 G-160 IP SNIPE NOSE CUTTING 160 mm

2444 CARPENTERS KNIFE

2509 FLEXIBLE PICK UP

2628 G-180IP COMBINATION PLIER 180 mm

268 MINIHACKSAW FRAMES

2744 MULTI-PURPOSE SNIPE

2951-180 GRIP 180 mm

2951-250 GRIP 250 mm

319-3906 HACKSAW FRAME

3625N-35 PLASTIC HAMMER

5515T TELESCOPIC MIRROR

59S/31-1 PZ1, PZ2 (x3), PZ3; PH1, PH2 (x3), PH3; PH2G (x2); T10, T15 (x3), T20 (x3), T25 (x2), T27, T30. SL: 3, 4, 5, 5.5 mm; HEX: 3 mm, 4, 5, 6 mm 1/4" Magnetic bit holder

6700SM SOCKET 1/4: 4, 4.5, 5, 5.5, 6, 7, 8, 9, 10, 11, 12, 13, 14 mm

6950 RATCHET 1/4 PEAR TYPE

6954 T-HANDLE

6956 SPINNER HANDLE 1/4

6960 EXTENSION 1/4 50 mm

6962 EXTENSION 1/4 150 mm

6966 UNIVERSAL JOINT 1/4

7800DM-10 SOCKET 1/2 8, 9, 10, 11, 12, 13, 14, 15, 16, 17, 18, 19, 20, 21, 22, 23, 24, 25, 26, 27, 28, 30, 32 mm

7805DM-10 1/2 DEEP SOCKET 10, 12, 13, 17, 19

8070 ADJUSTABLE WRENCH 6"

808050 RATCHETING BIT SCREWDRIVER

8154-1/2 T HANDLE 1/2

8155-1/2 RATCHET 1/2

8160-1/2 EXTENSION 125 mm

8162-1/2 EXTENSION 250 mm

8166-1/2 UNIVERSAL JOINT 1/2

8224 IP SLIP JOINT PLIER 250 mm

901T-010-100 TORX T-HANDLE 10 X 100

901T-015-150 TORX T-HANDLE 15 X 150

901T-020-150 TORX T-HANDLE 20 X 150

901T-025-150 TORX T-HANDLE 25 X 150

901T-027-150 TORX T-HANDLE 27 X 150

901T-030-200 TORX T-HANDLE 30 X 200

901T-040-200 TORX T-HANDLE 40 X 200

9031 ADJUSTABLE WRENCH

9072 P COMBINATION ADJUSTABLE WRENCH P 10"

BE-8020L SCREWDRIVER ERGO 0.5 X 3 X 75

BE-8040 SCREWDRIVER ERGO 0.8 X 4.0 X 100

BE-8150 SCREWDRIVER ERGO1.0 X 5.5 X 100

BE-8255 SCREWDRIVER ERGO 1.2 X 6.5 X 150

BE-8256 SCREWDRIVER ERGO1.6 X 8.0 X 150

BE-8340 SCREWDRIVER ERGO 0.8 X 4 X 25

BE-8601 SCREWDRIVER ERGO PH1 X 25

BE-8610 SCREWDRIVER ERGO PH1 X 75

BE-8620 SCREWDRIVER ERGOPH2 X 100

BE-9678 BLACK KEYS SETS FOR HEX SCREWS, LONG BALL END 1.5, 2, 2.5, 3, 4, 5, 6, 8, 10 mm

MTB-5-25 5M TAPE MEASURE 25 mm

GENERAL PURPOSE LARGE

FF1ASET-MAX

GENERAL PURPOSE COMPOSITION 5 DRAWERS

- General Purpose Large composition trolley:
 - 1/4 and 1/2 socket drivers
 - Combination wrenches
 - Slotted, PH and TORX screwdrivers
 - Bits covering all profiles
 - Pliers: Side Cutters, combination, snipe nose, slip joint pliers, etc.
 - Including adjustable, T handle, hammers, hand hacksaws and its frame
- Suitable for most of the applications
- Available for all 26" trolleys
- References for those foams are: FF1A5023, FF1A5024, FF1A5025 and FF1A5026



ERGO TOOL MANAGEMENT SYSTEM



GENERAL PURPOSE LARGE - 195 pcs

111M COMBINATION WRENCH 6, 7, 8, 9, 10, 11, 12, 13, 14, 15, 16, 17, 18, 19, 20 mm

141 PIPE WRENCH

1419-MD MAGNETIC DISH

1RM-10 RATCHET COMB.SPANNER 8, 9, 10, 11, 12, 13, 14, 15, 16, 17, 18, 19 mm

208-3906 HACKSAW FRAMES

2101G-160IP SIDE CUTTER 160 mm

2430 G-160 IP SNIPE NOSE CUTTING 160 mm

2444 CARPENTERS KNIFE

2509 FLEX. PICK UP

2628 G-180IP COMBINATION PLIER 180 mm

268 MINIHACKSAW FRAMES

2744 MULTI-PURPOSE SNIP

319-3906 HACKSAW FRAME

5515T TELESCOPIC MIRROR

59/S31 IMPACT BITS SET 31 PCS

6700SM SOCKET 1/4 4, 4.5, 5, 5.5, 6, 7, 8, 9, 10, 11, 12, 13, 14 mm

6950 RATCHET 1/4, PEAR TYPE 72T

6954 T-HANDLE 1/4

6956 SPINNER HANDLE 1/4

6960 EXTENSION 1/4 50 mm

6962 EXTENSION 1/4 150 mm

6966 UNIVERSAL JOINT 1/4

7400SM-10 SOCKET 3/8 6, 7, 8, 9, 10, 11, 12, 13, 14, 15, 16, 17, 18, 19, 20, 21, 22 mm

7754 T-HANDLE 3/8

7755-3/8 RATCHET 3/8, ERGO

7760 EXTENSION 3/8, 75 mm

7761 EXTENSION 3/8, 125 mm

7762 EXTENSION 3/8, 250 mm

7766 UNIVERSAL JOINT 3/8

7800DM SOCKET 1/2 8, 9, 10, 11, 12, 13, 14, 15, 16, 17, 18, 19, 20, 21, 22, 23, 24, 25, 26, 27, 28, 29, 30, 32 mm

7805DM 1/2 DEEP SOCKET 10, 12, 13, 17, 19 mm

7809M SOCKET 1/2, HEX 5, 6, 7, 8, 9, 10, 12, 14, 17, 19 mm

7809M-10-140 SOCKET 1/2 HEX.LONG

7809M-5-180 SOCKET 1/2 HEX.LONG

7809M-6-140 SOCKET 1/2 HEX.LONG

7809M-7-100 SOCKET 1/2 HEX.LONG

7809M-8-120 SOCKET 1/2 HEX.LONG

8070 ADJUSTABLE WRENCH 6"

808050 RATCHETING BIT SCREWDRIVER

8154-1/2 T HANDLE 1/2

8155-1/2 RATCHET 1/2

8160-1/2 EXTENSION 125 mm

8162-1/2 EXTENSION 250 mm

8166-1/2 UNIVERSAL JOINT 1/2

8224 IP SLIP JOINT PLIER 250 mm

9031 ADJUSTABLE WRENCH

9072 P COMB ADJUSTABLE P 10"

BE-8020L SCREWDRIVER ERGO 0,5 X 3 X 7BE-8040

BE-8040 SCREWDRIVER ERGO 0,8 X 4,0 X 100

BE-8150 SCREWDRIVER ERGO 1,0 X 5,5 X 100

BE-8255 SCREWDRIVER ERGO 1,2 X 6,5 X 150

BE-8256 SCREWDRIVER ERGO 1,6 X 8,0 X 150

BE-8340 SCREWDRIVER ERGO 0,8 X 4 X 25

BE-8601 SCREWDRIVER ERGO PH1 X 25

BE-8610 SCREWDRIVER ERGO PH1 X 75

BE-8620 SCREWDRIVER ERGO PH2 X 100

BE-9678 BLACK KEYS SETS FOR HEX SCREWS, LONG BALL END 1.5, 2, 2.5, 3, 4, 5, 6, 8, 10 mm

MTB-5-25 5M TAPE MEASURE 25 mm

APPLICATION COMPOSITIONS



ERGO TOOL MANAGEMENT SYSTEM

Aviation



Auto Repair



General Industry



Wind Power



Trades





TOOL TROLLEY

COMPOSITIONS - 114 PCS

- For general purpose
- Metric & inch
- 26 inches compositions. Equal to 3/3 dimensions from the modular system
- Its page is a composition but there is not mother code; you will have to order below codes + the tool trolley you wish
- Like this, you can also build up the aviation composition you want using the following eighteen 26 inches foam inserts



ERGO TOOL MANAGEMENT SYSTEM



FF1A01 - 77 pcs

A6800DM SOCKET 1/4", AEROSPACE LONG SERIES

4, 5, 6, 7, 8, 9, 10, 11, 12, 13

6700SM SOCKET 1/4", AEROSPACE SHORT SERIES

4, 4.5, 5, 5.5, 6, 7, 8, 9, 10, 11, 12, 13

6972H BIT HOLDER 1/4"

6950SL REVERSIBLE RATCHET 1/4", SLIMHEAD

6954 T-HANDLE 1/4"

6956 SPINNER HANDLE 1/4"

6960 EXTENSION BAR 1/4" 50 mm

6961 EXTENSION BAR 1/4" 100 mm

6966 UNIVERSAL JOINT 1/4"

7805ZZ-21 SPARK PLUG SOCKET 1/2"

7800SM SOCKET 1/2", SHORT SERIES

10, 11, 12, 13, 14, 15, 16, 17, 18, 19, 22, 24, 27, 30, 32

8150SL REVERSIBLE RATCHET 1/2", SLIMHEAD

8154-1/2 SLIDING T-HANDLE 1/2"

8159-1/2 EXTENSION BAR 1/2" 75mm

8162-1/2 EXTENSION BAR 1/2" 250 mm

8166-1/2 UNIVERSAL JOINT 1/2"

7807H BIT HOLDER 1/2"

59S/22-1 22 PCS RUBBER BIT HOLDER

PH, PZ, TORX®, SL

813 SCREWDRIVERS SLOTTED

4x100, 5.5x150 mm

815 SCREWDRIVERS PHILLIPS

PH1x100, PH2x125



FF1A02 - 19 pcs

6M OPEN END WRENCH

6x7, 8x9, 10x11, 12x13, 14x15, 16x17, 18x19, 20x22 mm

111M COMBINATION WRENCH

6, 7, 8, 10, 12, 13, 14, 17, 19, 22

808050L RATCHETING BIT SCREWDRIVER WITH LEDS



FF1A03 - 18 pcs

BE-9770 BLACK HEX KEYS SET, LONG BALL END, 9 PCS

1.5, 2, 2.5, 3, 4, 5, 6, 8, 10

2171G-160 SIDE CUTTER 160 mm

2678G-160 COMBINATION PLIER 160 mm

2971G-250 SLIP JOINT PLIER 250 mm

3734N DRIFT PUNCH 4x150, 6x150

481-400 DIN-HAMMER

306 HACKSAW FRAME AND SANDFLEX® BI-METAL BLADE

1-100-08-2-2 8" FLAT FILE, WITH HANDLE, SECOND

MTG-5-19 5m TAPE MEASURE 19mm



TOOL TROLLEY

COMPOSITIONS -172 PCS

- For general purpose
- Metric & inch
- 26 inches compositions. Equal to 3/3 dimensions from the modular system
- Its page is a composition but there is not mother code; you will have to order below codes + the tool trolley you wish
- Like this, you can also build up the aviation composition you want using the following eighteen 26 inches foam inserts



FF1A04 - 30 pcs

SARM FOUR SIZES RATCHETING WRENCH

8x11, 12x15, 16x19

111M COMBINATION WRENCH

6, 7, 8, 9, 10, 11, 12, 13, 14, 15, 16, 17, 18, 19, 21, 22, 24, 27, 30, 32

6M OPEN END WRENCH

6x7, 8x9, 10x11, 12x13, 14x15, 17x19

9071C ADJUSTABLE WRENCH CHROMED 8" ERGO™



FF1A05 - 104 pcs

BE-9678 BLACK KEYS SET, LONG BALL END 9 PCS

1.5, 2, 2.5, 3, 4, 5, 6, 8, 10

SBS60 SOCKET 1/4"

4, 4.5, 5, 5.5, 6, 7, 8, 9, 10, 11, 12, 13, 14

SBS61 RATCHET 1/4"

SBS63 EXTENSION BARS 1/4" 50, 100, 150mm

SBS64 T-HANDLE 1/4"

SBS65 UNIVERSAL JOINT 1/4"

SBS67 BREAKER BAR 1/4"

SBS69 ADAPTOR 1/4"-3/8"

6956 SPINNER HANDLE 1/4"

6972H BIT HOLDER 1/4"

SBS80 SOCKET 1/2"

10, 11, 12, 13, 14, 15, 16, 17, 18, 19, 21, 22, 24, 27, 30, 32

8150SL REVERSIBLE RATCHET 1/2" SLIMHEAD

8160-W EXTENSION BAR 1/2"

8159-1/2 EXTENSION BAR 1/2" 75mm

8162-1/2 EXTENSION BAR 1/2" 50mm

8166-1/2 UNIVERSAL JOINT 1/2"

8154-1/2 SLIDING T-HANDLE 1/2"

SBS88 ADAPTOR 1/2"-3/8"

7809M SOCKET DRIVER 1/2", HEX

5, 6, 7, 8, 10, 12, 14, 17, 19

7809TORX SOCKET DRIVER 1/2" TORX®

T20, T25, T27, T30, T40, T45, T50, T55, T60

808050 RATCHETING BIT SCREWDRIVER

59S/31-1 BITS SET

31 PCS: PH, PZ, TORX®, HEX, SL



FF1A06 - 23 pcs

BE-8020L / BE-8040 SCREWDRIVERS ERGO™ SLOTTED

0.5X3X75, 0.8X4,0X100

BE-8150 / BE-8255 / BE- 8256 SCREWDRIVERS ERGO™

SLOTTED

1,0X5,5X100, 1,2X6,5X150, 1,6X8,0X150

BE-8350 SCREWDRIVER ERGO™ SLOTTED, STUBBY

1X5,5X25

BE-8601 SCREWDRIVER ERGO™ PHILLIPS, STUBBY

PH1X25

BE-8610 / BE-8620 SCREWDRIVERS ERGO™ PHILLIPS

PH1X75, PH2X100

BE-8910 / BE-8930 SCREWDRIVERS ERGO™ TORX®

T10X75, T15X100, T20X100, T25X125, T27X125, T30X150

MTB-3-16 TAPE MEASURE

3 m

2101 G-160IP SIDE CUTTER ERGO™

2427 G-200IP SNIPE NOSE PLIER, BENT ERGO™

2628 G-160IP COMBINATION PLIER ERGO™

8224 IP SLIP JOINT PLIER ERGO™

2951-180 GRIP WITH WIRE CUTTER

5515T-52 TELESCOPIC SWIVEL HEAD MIRROR

Ø 50 mm

2535L MAGNETIC PICK-UP WITH LIGHT



FF1A07 - 15 pcs

3734N DRIFT PUNCH 3, 5, 6

3735N-4-120 CENTRE PUNCH

3740-175 FLAT CHISEL

SQZ150003 SQUEEZE KNIFE

1-100-08-2-2 8" FLAT FILE,

WITH HANDLE, SECOND

1-210-08-2-2 8" HALF ROUND FILE,

WITH HANDLE, SECOND

1-230-08-2-2 8" ROUND FILE, WITH HANDLE, SECOND

2744 MULTIPURPOSE SNIP 190 mm

317 HACKSAW FRAME AND SANDFLEX® BI-METAL BLADE

3625W-35 NYLON TIP HAMMER 35 mm

3745-150 CAPE CHISEL 150 mm

481-400 DIN-HAMMER

782-U UTILITY WIRE BRUSH



TOOL TROLLEY

COMPOSITIONS -273 PCS

- For general purpose
- Metric & inch
- 26 inches compositions. Equal to 3/3 dimensions from the modular system
- Its page is a composition but there is not mother code; you will have to order below codes + the tool trolley you wish
- Like this, you can also build up the aviation composition you want using the following eighteen 26 inches foam inserts



ERGO TOOL MANAGEMENT SYSTEM



FF1A08 - 138 pcs

6700SM SOCKET 1/4", AEROSPACE, SHORT SERIES

5.5, 6, 7, 8, 9, 10, 11, 12, 13

A6800DM SOCKET 1/4", AEROSPACE LONG SERIES

5.5, 6, 7, 8, 9, 10, 11, 12, 13

6709M SOCKET DRIVER 1/4", HEX

3, 4, 5, 6, 8

6709PH SOCKET DRIVER 1/4", PH

1, 2, 3

6709TORX SOCKET DRIVER 1/4", TORX®

T8, T9, T10, T15, T20, T25, T27, T30, T40

6950SL REVERSIBLE RATCHET 1/4", SLIMHEAD

6954 T-HANDLE 1/4"

6956 SPINNER HANDLE 1/4"

6958 BREAKER BAR 1/4"

6960 / 6961 / 6962 / 6962L EXTENSION BARS 1/4"

50, 100, 150, 355 mm

6966 UNIVERSAL JOINT 1/4"

6972H BIT HOLDER 1/4"

7764 ADAPTOR F 3/8" - M 1/4"

7400SM SOCKET 3/8", SHORT SERIES

6, 7, 8, 9, 10, 11, 12, 13, 14, 15, 16, 17, 18, 19, 22

A7402DM SOCKET 3/8", AEROSPACE

10, 11, 12, 13, 14, 15, 16, 17, 18, 19

7409M SOCKET DRIVER 3/8" HEX

3, 4, 5, 6, 7, 8, 10

7409TORX SOCKET DRIVER 3/8", TORX®

T25, T27, T30, T40, T45, T50

7750SL RATCHET 3/8" SLIMHEAD

7754 T-HANDLE 3/8"

7758 BREAKER BAR 3/8"

7760 / 7761 / 7762

EXTENSION BARS 3/8"

75, 125, 250 mm

7766 UNIVERSAL JOINT 3/8"

7765 ADAPTOR F 1/4" - M 3/8"

8164-1/2 ADAPTOR F 3/8" - M 1/2"

7407H SOCKET HOLDER 3/8"

1/4" - 3/8"

7800SM SOCKET 1/2" SHORT SERIES 10, 11, 12, 13, 14, 15,

16, 17, 18, 19, 21, 22, 24, 27, 30, 32

7809M SOCKET DRIVER 1/2", HEX

5, 6, 7, 8, 10, 12, 14, 17, 19

7809TORX SOCKET DRIVER 1/2", TORX®

T20, T25, T27, T30, T40, T45, T50, T55, T60

8154-1/2 T-HANDLE 1/2"

8150SL RATCHET 1/2", SLIMHEAD

8160-1/2 EXTENSION BAR 1/2",

125 mm

8162-1/2 EXTENSION BAR 1/2"

250 mm

8166-1/2 UNIVERSAL JOINT 1/2"

8165-1/2 ADAPTOR F 1/2" - M 3/8"

8964 ADAPTOR F 1/2" - M 3/4"

7807H SOCKET HOLDER 1/2"

2058-BR BIT-RATCHET 1/4"

1544 FEELER GAUGE



FF1A09 - 34 pcs

111M COMBINATION WRENCH

6, 7, 8, 9, 10, 11, 12, 13, 14, 15, 16, 17, 18, 19, 21, 22, 24, 27, 30, 32

6M OPEN END WRENCH

6x7, 8x9, 10x11, 12x13, 14x15, 16x17, 18x19, 20x22, 24x27, 30x32

9071C ADJUSTABLE WRENCH CHROMED 8" ERGO™

1320RM RATCHET RING WRENCH

8x9, 10x11, 12x13



TOOL TROLLEY

COMPOSITIONS - 273 PCS

- For general purpose
- Metric & inch
- 26 inches compositions. Equal to 3/3 dimensions from the modular system
- Its page is a composition but there is not mother code; you will have to order below codes + the tool trolley you wish
- Like this, you can also build up the aviation composition you want using the following eighteen 26 inches foam inserts



ERGO TOOL MANAGEMENT SYSTEM



FF1A10 - 66 pcs

808050P PISTOL HANDLE RATCHETING SCREWDRIVER

808050S RATCHETING SCREWDRIVER, STUBBY

59S/S31-1 BITS SET 31 PCS: PH, PZ, TORX®, HEX, SL

2047-0.8-4 OFFSET SCREWDRIVER 0.8X4X100

2047PR-1-2 DOUBLE OFFSET KEY FOR PHILLIPS SCREWS PH1 & 2

BE-8020L SCREWDRIVER ERGO™, SLOTTED 0.5X3X75

BE-8030 SCREWDRIVER ERGO™ SLOTTED 0.6X3.5X75

BE-8155 SCREWDRIVER ERGO™, SLOTTED 1.2X6.5X125

BE-8260 SCREWDRIVER ERGO™

SLOTTED, HEX PROFILE & BOLSTER 1.6X8.0X175

BE-8350 SCREWDRIVER ERGO™ SLOTTED, STUBBY 1X5.5X25

BE-8601 / BE-8602 SCREWDRIVERS ERGO™, PHILLIPS, STUBBY PH1X25, PH2X25

BE-8610 / BE-8630 SCREWDRIVERS ERGO™, PHILLIPS PH1X75, PH2X100, PH3X150

BE-8910 / BE-8620 / BE-8940 SCREWDRIVERS ERGO™, TORX® T10X75, T15X100, T20X100, T25X125, T27X125, T30X150, T40X150

BE-9770 BLACK HEX KEYS SET, LONG BALL END, 9 PCS HEX 1.5, 2, 2.5, 3, 4, 5, 6, 8, 10

MTB-3-16 MEASURING TAPE 3 m

1150-1/2H/P CALIPER 150 mm

1177-SCRIBE OFFSET SCRIBER 230 mm

5515T-52 TELESCOPIC SWIVEL HEAD MIRROR Ø 50 mm

2820EF2 ELECTRICIANS KNIFE 200 mm



FF1A11 - 16 pcs

2101GC SIDE CUTTERS ERGO™

125, 160 mm

21HDGC-200IP SIDE CUTTERS ERGO™

200 mm

2427 GC-200IP LONG, ROUND NOSE CHROMED PLIER, ERGO™ 200 mm

2430 GC-200 IP SNIPE NOSE CHROMED PLIER, ERGO™ 200 mm

2628 GC-160IP COMBINATION CHROMED PLIER, ERGO™ 160 mm

8224CIP SLIP JOINT PLIER, ERGO™

2951-250 GRIP WITH WIRE CUTTER

250 mm

2952-165 GRIP WITH EXTRA LONG NOSE

2928-160 PLIER, FOR INTERNAL & EXTERNAL CIRCLIPS INT. 7-26 mm, EXT. 3-26 mm

2928-200 PLIER, FOR INTERNAL & EXTERNAL CIRCLIPS INT. 10-51 mm, EXT. 7-51 mm

2928-250 PLIER, FOR INTERNAL & EXTERNAL CIRCLIPS INT. 46-102 mm, EXT. 32-102 mm

2928-1 / 2928-4 SPARE TIPS FOR 2928 SERIES

BFLA01 Q3 LED-TORCH



FF1A12 - 19 pcs

481-300 / 481-500 DIN HAMMER

300, 500 mm

3625W-35 NYLON TIP HAMMER

8158-1/2 BREAKER BAR 380 mm

2509 FLEXIBLE PICK-UP TOOL 525 mm

2535F2 MAGNETIC PICK-UP TOOL 1 kg

3734 DRIFT PUNCHES

Ø 3, 5, 8 mm

3735-4-120 CENTRE PUNCH

120 mm

3740-150 FLAT CHISEL

150 mm

3745-150 CAPE CHISEL

150 mm

1-100-06-1-2 6" FLAT FILE

WITH HANDLE, BASTARD

1-100-06-2-2 6" FLAT FILE,

WITH HANDLE, SECOND

1-160-06-1-2 6" SQUARE FILE,

WITH HANDLE, BASTARD

1-210-06-1-2 6" HALF ROUND FILE,

WITH HANDLE, BASTARD

1-230-06-1-2 6" ROUND FILE, WITH HANDLE, BASTARD

FS-8 SCISSORS

7.5 cm BLADE

319 HACKSAW FRAME AND

BI-METAL SANDFLEX® BLADE



TOOL TROLLEY

COMPOSITIONS - 241 PCS

- For aviation mechanics
- Metric & inch
- 26 inches compositions. Equal to 3/3 dimensions from the modular system
- Its page is a composition but there is not mother code; you will have to order below codes + the tool trolley you wish
- Like this, you can also build up the aviation composition you want using the following eighteen 26 inches foam inserts



ERGO TOOL MANAGEMENT SYSTEM



FF1A13 - 82 pcs

A6800DZ SOCKETS 1/4" BI-HEX, AEROSPACE LONG SERIES
3/16", 7/32", 1/4", 9/32", 5/16", 11/32", 3/8", 7/16", 1/2",
9/16"

A6800DM SOCKETS 1/4", AEROSPACE LONG SERIES
4", 10"

6700SZ-5/32 SOCKET 1/4", SHORT SERIES

A6700DZ SOCKETS 1/4", BI-HEX, AEROSPACE SHORT SERIES
3/16", 7/32", 1/4", 9/32", 5/16", 11/32", 3/8", 7/16", 1/2",
9/16"

A6710DZ SWIVEL SOCKETS 1/4", BI-HEX, AEROSPACE
3/16", 7/32", 1/4", 9/32", 5/16", 11/32", 3/8", 7/16", 1/2",
9/16"

6966 UNIVERSAL JOINT 1/4"

6950SL REVERSIBLE RATCHET 1/4", SLIMHEAD

6958 BREAKER BAR 1/4"

6954 T-HANDLE 1/4"

6956 SPINNER HANDLE 1/4"

6960 / 6961 / 6962 / 6962L EXTENSION BARS 1/4"
50, 100, 150, 355 mm

A7400DZ SOCKET 3/8" BI-HEX, AEROSPACE SHORT SERIES
1/4", 5/16", 3/8", 7/16", 1/2", 17/32", 9/16", 19/32", 5/8",
11/16", 3/4", 13/16", 7/8"

A7402DZ SOCKETS 3/8", BI-HEX, LONG SERIES, AEROSPACE
1/4", 5/16", 3/8", 7/16", 1/2", 9/16", 5/8", 19/32", 11/16",
3/4", 13/16", 7/8"

7766 UNIVERSAL JOINT 3/8"

7750SL RATCHET 3/8", SLIMHEAD

7758 BREAKER BAR 3/8"

7754 T-HANDLE 3/8"

7752 SPEEDER 3/8"

7760 / 7761 / 7762 EXTENSION BARS 3/8"

75, 125, 250 mm

7764 ADAPTOR F 3/8" - M 1/4"

7765 ADAPTOR F 1/4" - M 3/8"

8165-1/2 ADAPTOR F 1/2" - M 3/8"

8164-1/2 ADAPTOR F 3/8" - M 1/2"

6972H BIT HOLDER 1/4"

7407H BIT HOLDER 3/8" 1/4" - 3/8"

7408H BIT HOLDER 3/8" - 5/16" - 3/8"

S6106KA SOCKET SPARK PLUG 7/8"



FF1A15 - 12 pcs

8224CIP SLIP JOINT PLIER, ERGO™

2628 GC-160IP COMBINATION CHROMED PLIER, ERGO™
160 mm

2101GC SIDE CUTTING PLIER 125, 160 mm

2233D-240IP CABLE CUTTING PLIER 240 mm

2430 GC-200IP SNIPE NOSE PLIER 200 mm

2427 GC-200IP LONG, ROUND NOSE CHROMED PLIER,
ERGO™ 200 mm

2421GC-180IP FLAT NOSE PLIER 180 mm

2650 SLIP JOINT, CONNECTOR PLIER

2951-180 GRIP & WELDING PLIER 180 mm

2855 WIRE TWISTING PLIER 224 mm

2855 D WIRE TWISTING PLIER 282 mm



FF1A14 - 43 pcs

111Z COMBINATION WRENCHES

1/4", 5/16", 3/8", 7/16", 1/2", 9/16", 5/8", 11/16", 3/4",
13/16", 7/8", 15/16", 1"

1952Z-11/32 COMBINATION WRENCH
11/32"

1320RZ RATCHETING RING WRENCHES

1/4X5/16", 5/16X11/32", 3/8X7/16", 1/2X9/16"

1950MZ-3/8 CROWFOOT ADJUSTABLE WRENCH 3/8"

8069 C IP ADJUSTABLE CHROMED WRENCH 4" 110X13 mm

9070C ADJUSTABLE WRENCH CHROMED 6" ERGO™
158x20 mm

1931Z LILIPUT DOUBLE OPEN-END WRENCHES

5/32", 3/16", 7/32", 1/4", 9/32", 5/16", 11/32", 3/8", 7/16",
1/2", 9/16"

6Z DOUBLE OPEN-END WRENCHES

1/4X5/16", 5/16X11/32", 3/8X7/16, 1/2X9/16",
19/32X11/16", 5/8X3/4", 25/32X13/16", 7/8X15/16",
15/16X1", 1X1.1/8", 1.1/16X1.1/4"



TOOL TROLLEY

COMPOSITIONS - 241 PCS

- For aviation mechanics
- Metric & inch
- 26 inches compositions. Equal to 3/3 dimensions from the modular system
- Its page is a composition but there is not mother code; you will have to order below codes + the tool trolley you wish
- Like this, you can also build up the aviation composition you want using the following eighteen 26 inches foam inserts



ERGO TOOL MANAGEMENT SYSTEM



FF1A16 - 18 pcs

5515T POCKET TELESCOPIC MIRROR

Ø 30 mm

5515T-52 TELESCOPIC SWIVEL HEAD MIRROR

Ø 50 mm

1544 FEELER GAUGE

1150-1/2H/P CALIPER

150 mm

1179-FLX-2 FLEXIBLE MEASURE ROD

300 mm

MTB-3-16-E MEASURING TAPE

3 m

5471 F-145 GENERAL PURPOSE TWEEZER, STRAIGHT

145 mm

5516 GENERAL PURPOSE TWEEZER, ANGLE

150 mm

2744 MULTIPURPOSE SNIP

190 mm

2820EF2 ELECTRICIAN'S KNIFE WITH PLASTIC HANDLE

200 mm

2632 COMBINATION COTTER PIN EXTRACTOR AND

SPREADER

170 mm

1177-SCRIBE OFFSET SCRIBER 230 mm

3525HB THREE SQUARE MACHINIST'S SCRAPER

80/165 mm

268 JUNIOR HACKSAW 150 mm

2509 FLEXIBLE PICK-UP TOOL 525 mm

2535F2 MAGNETIC PICK-UP TOOL 1 kg

KE18-01 CUTTER KNIFE ERGO™

BFLA01 Q3 LED TORCH



FF1A17 - 61 pcs

BE-9780 BLACK HEX KEYS SET,

LONG BALL END, 12 PCS

0.050", 1/16", 5/64", 3/32", 7/64", 1/8", 9/64", 5/32", 3/16", 7/32", 1/4", 5/16"

BE-8020L / BE-8220 SLOTTED SCREWDRIVERS, ERGO™

0.5x3x75 mm, 0.5x3x125 mm

BE-8150 / BE-8155 SLOTTED SCREWDRIVERS, ERGO™

1x5.5x100 mm, 1.2x6.5x125 mm

BE-8260 SCREWDRIVER ERGO™

SLOTTED

1.6X8,0X175

BE-8610 / BE-8620 / BE-8630 PHILLIPS SCREWDRIVERS, ERGO™

PH1X75 mm, PH2X100 mm, PH3X150 mm

BE-8601 / BE-8602 PHILLIPS SCREWDRIVERS, ERGO™

PH1X25 mm, PH2X25 mm

2047-1-5.5 DOUBLE OFFSET KEY FOR SLOTTED SCREWS

1X5.5X125 mm

2047PR-1-2 DOUBLE OFFSET KEY FOR PHILLIPS SCREWS

PH1 & 2

706-2 PRECISION SCREWDRIVERS SET, FOR SLOTTED &

PHILLIPS SCREWS

1.0X50, 1.2X50, 1.5X50, 1.8X50 mm, PH0, PH00

2058-BR BIT-RATCHET 1/4"

59/S28-4 BITS SET FOR SLOTTED, PHILLIPS, TORX®,

HEXAGON AND TORQ-SET® HEAD SCREWS

28 PCS

BE-8350 SCREWDRIVER ERGO™

SLOTTED, STUBBY

1X5.5X25

808050 RATCHETING BIT SCREWDRIVER



FF1A18 - 25 pcs

3736S/6 SET OF CHISELS

6 PCS

3734S/6 SET OF DRIFT PUNCHES,

6 PCS

2-8 x 150 Ø mm

481 DIN HAMMER

200, 500 gr

3625N-35 SUPERFLEX PLASTIC HAMMER

35 mm

782-U GENERAL PURPOSE UTILITY WIRE BRUSH

290 mm

1-476-04-3-2 4" HAND FILE SET,

WITH HANDLE: HAND, WARDING, SQUARE, THREE SQUARE,

HALF ROUND AND ROUND

2633/S4 SET INCLUDES AWL, HOOKS & PICKS, 4 PCS



HIGH PROTECTION RIGID CASES COMPOSITIONS

■ 4750RCHDW01FF1

240 PCS

- Aviation Mechanics, especially for mobile application
- Hardware: 4750RCHDW01. Heavy Duty Rigid Case with wheels
- Metric & inch
- Sizes: 1/4; 3/8



ERGO TOOL MANAGEMENT SYSTEM



FF2B01 - 61 pcs

A6700DZ SOCKETS 1/4", BI-HEX, AEROSPACE SHORT SERIES
3/16", 7/32", 1/4", 9/32", 5/16", 11/32", 3/8", 7/16", 1/2", 9/16"

A6800DZ SOCKETS 1/4", BI-HEX, AEROSPACE LONG SERIES
3/16", 7/32", 1/4", 9/32", 5/16", 11/32", 3/8", 7/16", 1/2", 9/16"

6950SL REVERSIBLE RATCHET 1/4", SLIMHEAD

6954 T-HANDLE 1/4"

6956 SPINNER HANDLE 1/4"

6958 BREAKER BAR 1/4"

6960 / 6961 EXTENSION BARS 1/4"

50, 100 mm

6962L EXTENSION BAR 1/4"

355 mm

6966 UNIVERSAL JOINT 1/4"

7764 ADAPTOR F 3/8" - M 1/4"

7765 ADAPTOR F 1/4" - M 3/8"

6972H BIT HOLDER 1/4"

A7402DZ SOCKETS 3/8", BI-HEX, LONG SERIES, AEROSPACE
1/4", 5/16", 3/8", 7/16", 1/2", 9/16", 19/32", 5/8", 11/16", 3/4"

A7400DZ SOCKETS 3/8", AEROSPACE SHORT SERIES

1/4", 5/16", 3/8", 7/16", 1/2", 17/32", 9/16", 19/32", 5/8", 11/16", 3/4"

7750SL RATCHET 3/8" SLIMHEAD

7752 SPEEDER 3/8"

7760 / 7761 / 7762 EXTENSION BARS 3/8"

75, 125, 250 mm

7766 UNIVERSAL JOINT 3/8"

8164-1/2 ADAPTOR F 3/8" - M 1/2"

7407H SOCKET HOLDER 3/8"

1/4" - 3/8"

S6106KA SPARK PLUG SOCKET 7/8"



FF2B02 - 69 pcs

A6700DM SOCKETS 1/4", BI-HEX, AEROSPACE SHORT SERIES
5.5, 6, 7, 8, 9, 10, 11, 12, 13, 14

A6800DM SOCKETS 1/4", AEROSPACE LONG SERIES
4.5, 5.5, 6, 7, 8, 9, 10, 11, 12, 13, 14

A7400DM SOCKETS 3/8", BI-HEX, AEROSPACE SHORT SERIES
10, 11, 12, 13, 14, 15, 16, 17, 18, 19

10, 11, 12, 13, 14, 15, 16, 17, 18, 19

A7402DM SOCKETS 3/8", BI-HEX, LONG SERIES, AEROSPACE

10, 11, 12, 13, 14, 15, 16, 17, 18, 19

4020L-M LILIPUT COMBINATION WRENCH

5, 5.5 mm

111M COMBINATION WRENCHES

6, 7, 8, 9, 10, 11, 12, 13, 14, 15, 16, 17, 18, 19, 22, 24

BE-9770 BLACK HEX KEYS SET, LONG BALL END, 9 PCS

1.5, 2, 2.5, 3, 4, 5, 6, 8, 10 mm



FF2B03 - 44 pcs

A6710DZ SWIVEL SOCKETS 1/4", BI-HEX, AEROSPACE
3/16, 7/32, 1/4, 9/32, 5/16, 11/32, 3/8, 7/16, 1/2, 9/16

A6710DM-7 SWIVEL SOCKETS 1/4", BI-HEX, AEROSPACE
7 mm

2058-BR BIT-RATCHET 1/4"

1950MZ-3/8 CROWFOOT ADJUSTABLE WRENCH 3/8"

BE-9780 BLACK HEX KEYS SET,

LONG BALL END, 12 PCS

0.050", 1/16", 5/64", 3/32", 7/64", 1/8", 9/64", 5/32", 3/16", 7/32", 1/4", 5/16"

111Z COMBINATION WRENCHES

1/4", 5/16", 3/8", 7/16", 1/2", 9/16", 5/8", 11/16", 3/4", 13/16", 7/8", 1"

1320RZ RATCHETING RING WRENCHES

1/4X5/16", 5/16X11/32", 3/8X7/16", 1/2X9/16"

1931Z LILIPUT DOUBLE OPEN-END WRENCHES

3/16", 7/32", 1/4"



HIGH PROTECTION RIGID CASES COMPOSITIONS

■ 4750RCHDW01FF1

240 PCS

- Aviation Mechanics, especially for mobile application
- Hardware: 4750RCHDW01. Heavy Duty Rigid Case with wheels
- Metric & inch
- Sizes: 1/4; 3/8



ERGO TOOL MANAGEMENT SYSTEM



FF2B04 - 45 pcs

9070C ADJUSTABLE WRENCH CHROMED 6" ERGO™

158x20 mm

2509 FLEXIBLE PICK-UP TOOL

525 mm

808050 RATCHETING BIT SCREWDRIVER

59/S28-4 BITS SET FOR SLOTTED, PHILLIPS, TORX®,
HEXAGON AND TORQ-SET® HEAD SCREWS

28 PCS

701 PRECISION SCREWDRIVERS FOR PHILLIPS HEAD
SCREWS

PH00X50, PH0X50

700 PRECISION SCREWDRIVERS HEAD SCREWS, SLOTTED

1.5X50, 1X50

BE-8020L / BE-8040 SCREWDRIVERS ERGO™, SLOTTED

0.5X3X75, 0.8X4.0X100

BE-8150 / BE-8255 SCREWDRIVERS ERGO™ SLOTTED

1.0X5.5X100, 1.2X6.5X115

BE-8610 / BE-8620 SCREWDRIVERS ERGO™ PHILLIPS

PH1X75, PH2X100

BE-8080-10 SCREWDRIVER

TORQ-SET, ERGO™

10X100

2535F2 MAGNETIC PICK-UP TOOL

1 kg

5516 GENERAL PURPOSE TWEEZER

150 mm

1544 FEELER GAUGE



FF2B05 - 15 pcs

5515T-52 TELESCOPIC SWIVEL HEAD MIRROR

Ø 50mm

2650 SLIP JOINT, CONNECTOR PLIER

2855 WIRE TWISTING PLIER

224 mm

4130 SIDE CUTTING PLIER, ERGO™

120 mm

2101GC SIDE CUTTING PLIER, ERGO™

125 mm, 160mm

2427 GC-200IP LONG, ROUND NOSE CHROMED PLIER,
ERGO™

160 mm

2628 GC-160IP COMBINATION PLIER, CHROMED, ERGO™

160 mm

8224CIP SLIP JOINT PLIER, ERGO™

4830 FINE MECHANICAL SNIPER NOSE PLIER, ERGO™

2820EF2 ELECTRICIAN'S KNIFE

200 mm

BFLA01 Q3 LED-TORCH

MTB-3-16-E MEASURING TAPE

3 m

1150-1/2H/P CALIPER

150 mm

1179-FLX-2 FLEXIBLE MEASURING ROD

300 mm



FF2B06 - 6 pcs

3625N-32 PLASTIC HAMMER

481-300 DIN HAMMER

300 mm

3734 DRIFT PUNCHES

Ø 3, 5, 8 mm

3735-5-120 CENTRE PUNCH

5X120 mm



HIGH PROTECTION RIGID CASES COMPOSITIONS

■ 475ORCHDW01FF2

159 PCS

- Aviation Mechanics, especially for mobile application
- Hardware: 475ORCHDW01. Heavy Duty Rigid Case with wheels
- Suitable for all airplanes
- Inch
- Sizes: 1/4; 3/8



ERGO TOOL MANAGEMENT SYSTEM



FF2B07 - 62 pcs

A6700DZ SOCKET 1/4" BI-HEX, AEROSPACE

3/16", 7/32", 1/4", 9/32", 5/16", 3/8", 11/32", 7/16", 1/2", 9/16"

A6710DZ SWIVEL SOCKETS 1/4", BI-HEX, AEROSPACE

5/16", 3/8", 7/16",

A6800DZ SOCKETS 1/4" BI-HEX, AEROSPACE

3/16", 7/32", 1/4", 9/32", 5/16", 3/8", 11/32", 7/16", 1/2", 9/16"

A7400DZ SOCKETS 3/8" BI-HEX, SHORT SERIES, AEROSPACE

3/8", 7/16", 1/2", 9/16", 19/32", 5/8", 11/16", 3/4", 13/16", 7/8"

A7402DZ SOCKETS 3/8" BI-HEX, LONG SERIES, AEROSPACE

3/8", 7/16", 1/2", 9/16", 19/32", 5/8", 11/16", 3/4", 13/16", 7/8"

6950SL REVERSIBLE RATCHET 1/4", SLIMHEAD

6954 T-HANDLE 1/4"

6956 SPINNER HANDLE 1/4"

6960 / 6962 EXTENSION BARS 1/4" 50, 150 mm

6962L EXTENSION BAR 1/4" 355 mm

6966 UNIVERSAL JOINT 1/4"

6972H BIT HOLDER 1/4"

7407H BIT HOLDER 3/8" 1/4" - 3/8"

7408H BIT HOLDER 3/8" 5/16" - 3/8"

7752 SPEEDER 3/8"

7750SL RATCHET 3/8" SLIMHEAD

7760 / 7762 EXTENSION BARS 3/8" 75, 125, 250 mm

7764 ADAPTOR F 3/8" - M 1/4"

7765 ADAPTOR F 1/4" - M 3/8"

7766 UNIVERSAL JOINT 3/8"

8164-1/2 ADAPTOR F 3/8" - M 1/2"

7407H BIT HOLDER 3/8" 1/4" - 3/8"

7408H BIT HOLDER 3/8" 5/16" - 3/8"

7752 SPEEDER 3/8"

7750SL RATCHET 3/8" SLIMHEAD

7760 / 7762 EXTENSION BARS 3/8" 75, 125, 250 mm

7764 ADAPTOR F 3/8" - M 1/4"

7765 ADAPTOR F 1/4" - M 3/8"

7766 UNIVERSAL JOINT 3/8"

8164-1/2 ADAPTOR F 3/8" - M 1/2"

7760 / 7762 EXTENSION BARS 3/8"

75, 125, 250 mm

7764 ADAPTOR F 3/8" - M 1/4"

7765 ADAPTOR F 1/4" - M 3/8"

7766 UNIVERSAL JOINT 3/8"

8164-1/2 ADAPTOR F 3/8" - M 1/2"



FF2B08 - 25 PCS

111Z COMBINATION WRENCHES

1/4", 5/16", 3/8", 7/16", 1/2", 9/16", 5/8", 11/16", 3/4", 7/8", 1"

1320RZ RATCHETING RING WRENCHES

1/4X5/16", 5/16X11/32", 3/8X7/16", 1/2X9/16"

1931Z LILIPUT DOUBLE OPEN-END WRENCHES

3/16", 7/32", 1/4"

9031 C ADJUSTABLE WRENCH 8", ERGO™, CHROMED

218x38 mm

208 MINI HACKSAW FRAMES

250 mm

1-100-04-2-2 4" FLAT FILE, ERGO™, WITH HANDLE, SECOND 4"

1-230-04-2-2 4" ROUND HAND FILE, ERGO™, WITH HANDLE, SECOND 4"

2058-BR BIT-RATCHET 1/4"

1177-SCRIBE OFFSET SCRIBER 230mm

1950MZ-3/8 CROWFOOT ADJUSTABLE WRENCH 3/8"



HIGH PROTECTION RIGID CASES COMPOSITIONS

4750RCHDW01FF2

159 PCS

- Aviation Mechanics, especially for mobile application
- Hardware: 4750RCHDW01. Heavy Duty Rigid Case with wheels
- Suitable for all airplanes
- Inch
- Sizes: 1/4; 3/8



ERGO TOOL MANAGEMENT SYSTEM



FF2B09 - 56 PCS

BE-8210 / BE-8040 SCREWDRIVERS ERGO™ SLOTTED

0,4X2, 5X75, 0,8X4, 0X100 mm

BE-8150 SCREWDRIVERS ERGO™ SLOTTED

1,0X5, 5X100 mm

BE-8260 SCREWDRIVER ERGO™

SLOTTED, HEX PROFILE & BOLSTER

1,6X8,0X175

BE-8600 / BE-8620 SCREWDRIVERS ERGO™ PHILLIPS

PH0X60, PH1X75, PH2X100

BE-9780 BLACK HEX KEYS SET,

LONG BALL END, 12 PCS

0,050", 1/16", 5/64", 3/32", 7/64", 1/8", 9/64", 5/32", 3/16",
7/32", 1/4", 5/16"

2047PR-1-2 DOUBLE OFFSET KEY FOR PHILLIPS SCREWS

PH1 & 2

2047-1-5.5 DOUBLE OFFSET KEY FOR SLOTTED SCREWS

1X5, 5X125 mm

BFLA01 Q3 LED-TORCH

59/S28-4 BITS SET FOR SLOTTED, PHILLIPS, TORX®,

HEXAGON AND TORQ-SET® HEAD SCREWS

28 PCS

808050 RATCHETING BIT SCREWDRIVER

MTB-3-16-E MEASURING TAPE

3 m

1179-FLX-2 FLEXIBLE MEASUR. ROD 300mm/inch

5515T-52 TELESCOPIC SWIVEL HEAD MIRROR

Ø 50 mm

2509 FLEXIBLE PICK-UP TOOL

525 mm

2535F2 MAGNETIC PICK-UP TOOL

1 kg



FF2B10 - 9 PCS

2101GC-160IP SIDE CUTTING PLIER, ERGO™

160 mm

2650 SLIP JOINT, CONNECTOR PLIER

160 mm

2628 GC-160IP COMBINATION CHROMED PLIER, ERGO™

160 mm

2427 GC-200IP LONG, ROUND NOSE CHROMED PLIER,

ERGO™

200 mm

2430 GC-200 IP SNIPE NOSE CHROMED PLIER, ERGO™

200 mm

2855 WIRE TWISTING PLIER

224 mm

2744 MULTIPURPOSE SNIP

190 mm

8224CIP SLIP JOINT PLIER, ERGO™

180/3-13 mm

2979 D-180 FLAT NOSE NUT PLIER

180/3-13 mm



FF2B11 - 7 PCS

481-300 DIN HAMMER

300 mm

3625N-32 PLASTIC HAMMER

300 mm

3734 DRIFT PUNCHES

Ø 2, 3, 4, 5 mm

2632 COMBINATION COTTER PIN EXTRACTOR AND

SPREADER

170 mm



HIGH PROTECTION RIGID CASES COMPOSITIONS

■ 475ORCHDW01FF3

194 PCS

- For general purpose
- Hardware: 475ORCHDW01. Heavy Duty Rigid Case with wheels
- Metric
- Sizes: 1/4"; 3/8"



ERGO TOOL MANAGEMENT SYSTEM



FF2B12 - 92 pcs

6700SM SOCKET 1/4", AEROSPACE, SHORT SERIES

5.5, 6, 7, 8, 9, 10, 11, 12, 13

A6800DM SOCKET 1/4", AEROSPACE LONG SERIES

5.5, 6, 7, 8, 9, 10, 11, 12, 13

6709M SOCKET DRIVER 1/4", HEX

3, 4, 5, 6, 8

6709PH SOCKET DRIVER 1/4", PH

1, 2, 3

6709TORX SOCKET DRIVER 1/4", TORX®

T8, T9, T10, T15, T20, T25, T27, T30, T40

6950SL REVERSIBLE RATCHET 1/4", SLIMHEAD

6954 T-HANDLE 1/4"

6956 SPINNER HANDLE 1/4"

6958 BREAKER BAR 1/4"

6960 / 6962 EXTENSION BARS 1/4"

50, 100, 150 mm

6962L EXTENSION BAR 1/4"

355 mm

6966 UNIVERSAL JOINT 1/4"

6972H BIT HOLDER 1/4"

7764 ADAPTOR F 3/8" - M 1/4"

7400SM SOCKET 3/8" SHORT SERIES 6, 7, 8, 9, 10, 11, 12, 13, 14, 15, 16, 17, 18, 19, 22

A7402DM SOCKET 3/8", AEROSPACE

10, 11, 12, 13, 14, 15, 16, 17, 18, 19

7409M SOCKET DRIVER 3/8" HEX

3, 4, 5, 6, 7, 8, 10

7409TORX SOCKET DRIVER 3/8", TORX®

T25, T27, T30, T40, T45, T50

7750SL RATCHET 3/8" SLIMHEAD

7760 / 7762 EXTENSION BARS 3/8"

75, 125, 250 mm

7766 UNIVERSAL JOINT 3/8"

7765 ADAPTOR F 1/4" - M 3/8"

8164-1/2 ADAPTOR F 3/8" - M 1/2"

7407H SOCKET HOLDER 3/8"

1/4" - 3/8"



FF2B13 - 39 pcs

111M COMBINATION WRENCH

6, 7, 8, 9, 10, 11, 12, 13, 14, 15, 16, 17, 18, 19, 21, 22

6M OPEN END WRENCH

6x7, 8x9, 10x11, 12x13, 14x15, 16x17, 18x19, 20x22

BE-9770 BLACK HEX KEYS SET, LONG BALL END, 9 PCS

1.5, 2, 2.5, 3, 4, 5, 6, 8, 10 mm

9070C ADJUSTABLE WRENCH CHROMED 6" ERGO™

158x20 mm

1177-SCRIBE OFFSET SCRIBER

230 mm

2535F2 MAGNETIC PICK UP

1 kg

7758 BREAKER BAR

BFLA01 Q3 LED-TORCH

7754 T-HANDLE 3/8"



HIGH PROTECTION RIGID CASES COMPOSITIONS

■ 475ORCHDW01FF3

194 PCS

- For general purpose
- Hardware: 475ORCHDW01. Heavy Duty Rigid Case with wheels
- Metric
- Sizes: 1/4"; 3/8"



ERGO TOOL MANAGEMENT SYSTEM



FF2B14 - 48 pcs

808050P PISTOL HANDLE RATCHETING SCREWDRIVER

808050S RATCHETING SCREWDRIVER, STUBBY

59S/31-1 BITS SET

31 PCS: PH, PZ, TORX®, HEX, SL

2047-0.8-4 OFFSET SCREWDRIVER

0.8X4X100

2047PR-1-2 DOUBLE OFFSET KEY FOR PHILLIPS SCREWS

PH1 & 2

BE-8020L SCREWDRIVER ERGO™, SLOTTED

0.5X3X75

BE-8030 SCREWDRIVER ERGO™

SLOTTED

0.6X3.5X75

BE-8155 SCREWDRIVER ERGO™

SLOTTED

1.2X6.5X125

BE-8260 SCREWDRIVER ERGO™

SLOTTED, HEX PROFILE & BOLSTER

1.6X8.0X175

BE-8350 SCREWDRIVER ERGO™

SLOTTED, STUBBY

1X5.5X25

BE-8601 / BE-8602 SCREWDRIVERS ERGO™, PHILLIPS,

STUBBY

PH1X25, PH2X25

BE-8610 / BE-8630 SCREWDRIVERS ERGO™, PHILLIPS

PH1X75, PH2X100, PH3X150

2058-BR BIT-RATCHET 1/4"

1544 FEELER GAUGE

2509 FLEXIBLE PICK-UP TOOL

525 mm



FF2B15 - 9 pcs

MTB-3-16-E MEASURING TAPE ENGLISH

3 m

2101GC-160IP SIDE CUTTING PLIER, ERGO™

160 mm

2427 GC-200IP LONG, ROUND NOSE CHROMED PLIER,

ERGO™

200 mm

2430 GC-200 IP SNIPE NOSE CHROMED PLIER, ERGO™

200 mm

2628 GC-160IP COMBINATION CHROMED PLIER, ERGO™

160 mm

8224CIP SLIP JOINT PLIER, ERGO™

1150-1/2H/P CALIPER

150 mm

5515T-52 TELESCOPIC SWIVEL HEAD MIRROR

Ø 50 mm

2820EF2 ELECTRICIANS KNIFE



FF2B16 - 6 pcs

481-300 DIN HAMMER

300 mm

3625W-35 NYLON TIP HAMMER

3734 DRIFT PUNCHES

Ø 3, 5, 8 mm

3735-4-120 CENTRE PUNCH

120 mm



HIGH PROTECTION RIGID CASES COMPOSITIONS

■ 475ORCHD01FF1

159 PCS

- Aviation Mechanics, especially for mobile application
- Hardware: 475ORCHD01. Heavy Duty Rigid Case without wheels
- Suitable for all airplanes
- Inch
- Sizes: 1/4; 3/8



ERGO TOOL MANAGEMENT SYSTEM



FF2A07 - 64 pcs

A6700DZ SOCKET 1/4" BI-HEX, AEROSPACE SHORT SERIES

3/16", 7/32", 1/4", 9/32", 5/16", 3/8", 11/32", 7/16", 1/2", 9/16"

A6710DZ SWIVEL SOCKETS 1/4",

BI-HEX, AEROSPACE

1/4", 5/16", 3/8", 7/16"

A6800DZ SOCKETS 1/4" BI-HEX, LONG, AEROSPACE

3/16", 7/32", 1/4", 9/32", 5/16", 3/8", 11/32", 7/16", 1/2", 9/16"

A7400DZ SOCKETS 3/8" BI-HEX, SHORT SERIES, AEROSPACE

3/8", 7/16", 1/2", 9/16", 19/32", 5/8", 11/16", 3/4", 13/16", 7/8"

A7402DZ SOCKETS 3/8", BI-HEX, LONG SERIES, AEROSPACE

3/8", 7/16", 1/2", 9/16", 19/32", 5/8", 11/16", 3/4", 13/16", 7/8"

6950SL REVERSIBLE RATCHET 1/4", SLIMHEAD

6954 T-HANDLE 1/4"

6956 SPINNER HANDLE 1/4"

6962L EXTENSION BAR 1/4"

355 mm

6966 UNIVERSAL JOINT 1/4"

6972H BIT HOLDER 1/4"

7407H BIT HOLDER 3/8"

1/4" - 3/8"

7408H BIT HOLDER 3/8"

5/16" - 3/8"

7752 SPEEDER 3/8"

7750SL RATCHET 3/8" SLIMHEAD

7760 / 7762 EXTENSION BARS 3/8"

75, 125, 250 mm

7764 ADAPTOR F 3/8" - M 1/4"

7765 ADAPTOR F 1/4" - M 3/8"

7766 UNIVERSAL JOINT 3/8"

8164-1/2 ADAPTOR F 3/8" - M 1/2"

2058-BR BIT-RATCHET 1/4"

6960 / 6962 EXTENSION BARS 1/4"

50, 150 mm



FF2A08 - 24 pcs

111Z COMBINATION WRENCHES

1/4", 5/16", 3/8", 7/16", 1/2", 9/16", 5/8", 11/16", 3/4", 7/8", 1"

1320RZ RATCHETING RING WRENCHES

1/4X5/16", 5/16X11/32", 3/8X7/16", 1/2X9/16"

1931Z LILIPUT DOUBLE OPEN-END WRENCHES

3/16", 7/32", 1/4"

9031 C ADJUSTABLE WRENCH 8", ERGO™, CHROMED

218x38 mm

208 MINI HACKSAW FRAMES

250 mm

1-100-04-2-2 4" FLAT FILE, ERGO™, WITH HANDLE, SECOND

1-230-04-2-2 4" ROUND HAND FILE, ERGO™, WITH HANDLE, SECOND

1177-SCRIBE OFFSET SCRIBER 230mm

1950MZ-3/8 CROWFOOT ADJUSTABLE WRENCH 3/8"



HIGH PROTECTION RIGID CASES COMPOSITIONS

■ 4750RCHD01FF1

159 PCS

- Aviation Mechanics, especially for mobile application
- Hardware: 4750RCHD01. Heavy Duty Rigid Case without wheels
- Suitable for all airplanes
- Inch
- Sizes: 1/4; 3/8



ERGO TOOL MANAGEMENT SYSTEM



FF2A09 - 56 pcs

BE-8210 SCREWDRIVERS ERGO™ SLOTTED

0.4X2, 5X75 mm

BE-8040 SCREWDRIVER ERGO™ SLOTTED

0.8X4,0X100

BE-8150 SCREWDRIVERS ERGO™ SLOTTED

1,0X5, 5X100 mm

BE-8260 SCREWDRIVER ERGO™

SLOTTED, HEX PROFILE & BOLSTER

1,6X8,0X175

BE-8600 / BE-8620 SCREWDRIVERS ERGO™ PHILLIPS

PH0X60, PH1X75, PH2X100

BE-9780 BLACK HEX KEYS SET,

LONG BALL END, 12 PCS

0.050", 1/16", 5/64", 3/32", 7/64", 1/8", 9/64", 5/32", 3/16",
7/32", 1/4", 5/16"

2047-1-5.5 DOUBLE OFFSET KEY FOR SLOTTED SCREWS

1X5, 5X125 mm

BFLA01 Q3 LED-TORCH

59/S28-4 BITS SET FOR SLOTTED, PHILLIPS, TORX®,

HEXAGON AND TORQ-SET® HEAD SCREWS

28 PCS

08050 RATCHETING BIT SCREWDRIVER

MTB-3-16-E MEASURING TAPE

3 m

1179-FLX-2 FLEXIBLE MEASUR. ROD 300mm/inch

5515T-52 TELESCOPIC SWIVEL HEAD MIRROR

Ø 50 mm

2509 FLEXIBLE PICK-UP TOOL

525 mm

2535F2 MAGNETIC PICK-UP TOOL

1 kg



FF2A10 - 15 pcs

481-300 DIN HAMMER

300 mm

3625W-35 PLASTIC HAMMER

2101GC-160IP SIDE CUTTING PLIER, ERGO™

160 mm

2650 SLIP JOINT, CONNECTOR PLIER

2628 GC-160IP COMBINATION CHROMED PLIER, ERGO™

160 mm

2427 GC-200IP LONG, ROUND NOSE CHROMED PLIER,

ERGO™

200 mm

2855 WIRE TWISTING PLIER

224 mm

Ø224CIP SLIP JOINT PLIER, ERGO™

3734-2 DRIFT PUNCHES

2-150, 3-150, 4-150, 5-150 mm

3735-4-120 CENTRE PUNCH

120 mm

2632 COMBINATION COTTER PIN EXTRACTOR AND

SPREADER

170 mm

2979 D-180 FLAT NOSE NUT PLIER

180/3-13 mm



METALLIC CASES COMPOSITIONS

■ 1483KHD3RB-FF1

129 PCS

- Aviation Mechanics, suitable for all large airplanes
- Hardware: 1483KHD3RB. Heavy Duty Rigid Case without wheels
- Especially for line maintenance
- Inch
- Sizes: 1/4"; 3/8"



ERGO TOOL MANAGEMENT SYSTEM



LID ASSORTMENT - 5 pcs

481-500 DIN HAMMER

500 mm

3625N-32 PLASTIC HAMMER

2509 FLEXIBLE PICK-UP TOOL

525 mm

8162-1/2 EXTENSION BAR 1/2"

250 mm

7762 EXTENSION BAR 3/8"

250 mm



FF3A01 - 79 pcs

6Z DOUBLE OPEN-END WRENCHES

7/8x15/16", 1x1.1/8", 1.1/16-1.1/4"

6950SL REVERSIBLE RATCHET 1/4", SLIMHEAD

6956 SPINNER HANDLE 1/4"

6958 BREAKER BAR 1/4"

6960 EXTENSION BAR 1/4"

50 mm

6961 EXTENSION BAR 1/4"

100 mm

6966 UNIVERSAL JOINT 1/4"

7750SL RATCHET 3/8" SLIMHEAD

7752 SPEEDER 3/8"

7760 / 7761 EXTENSION BARS 3/8"

75, 125 mm

7764 ADAPTOR F 3/8" - M 1/4"

7765 ADAPTOR F 1/4" - M 3/8"

7766 UNIVERSAL JOINT 3/8"

6972H BIT HOLDER 1/4"

7407H BIT HOLDER 3/8"

1/4" - 3/8"

8164-1/2 ADAPTOR F 3/8" - M 1/2"

8165-1/2 ADAPTOR F 1/2" - M 3/8"

A6700DZ SOCKET 1/4", BI-HEX, AEROSPACE SHORT SERIES

7/32", 1/4", 9/32", 5/16", 11/32", 3/8", 7/16", 1/2",

A6800DZ SOCKETS 1/4" BI-HEX, AEROSPACE LONG SERIES

7/32", 1/4", 9/32", 5/16"

A7400DM SOCKETS 3/8", BI-HEX, AEROSPACE SHORT

SERIES 10, 13 mm

A7400DZ SOCKETS 3/8", BI-HEX, SHORT SERIES

1/2", 9/16", 5/8", 11/16", 3/4"

A7402DZ SOCKETS 3/8", BI-HEX, LONG SERIES, AEROSPACE

3/8", 7/16", 1/2", 9/16"

7800DZ SOCKET 1/2", BI-HEX SHORT SERIES

13/16", 7/8", 1"

59/S28-4 BITS SET FOR SLOTTED, PHILLIPS, TORX®,

HEXAGON AND TORQ-SET® HEAD SCREWS 28 PCS

A6710DZ SWIVEL SOCKETS 1/4",

BI-HEX, AEROSPACE 5/16", 3/8", 7/16"

1320RZ RATCHETING RING WRENCHES

1/4X5/16", 3/8X7/16"



1483KCART



METALLIC CASES COMPOSITIONS

■ 1483KHD3RB-FF1

129 PCS

- Aviation Mechanics, suitable for all large airplanes
- Hardware: 1483KHD3RB. Heavy Duty Rigid Case without wheels
- Especially for line maintenance
- Inch
- Sizes: 1/4; 3/8



ERGO TOOL MANAGEMENT SYSTEM



FF3A02 - 13 pcs

2047-1.2-8 OFFSET SCREWDRIVER

1.2X8X150

2047PR-1-2 DOUBLE OFFSET KEY FOR PHILLIPS SCREWS

PH1 & 2

BE-8020L SCREWDRIVER ERGO™, SLOTTED

0.5X3X75

BE-8155 SCREWDRIVER ERGO™,

SLOTTED

1.2X6.5X125

BE-8260 SCREWDRIVER ERGO™

SLOTTED, HEX PROFILE & BOLSTER

1.6X8.0X175

BE-8611 / BE-8621 SCREWDRIVERS ERGO™, PHILLIPS

PH1X75, PH2X100

BE-8601 SCREWDRIVER ERGO™ PHILLIPS, STUBBY

PH1X25

9715-14-250 THROUGH BLADE SCREWDRIVER

2.5x14x250

5515T-52 TELESCOPIC SWIVEL HEAD MIRROR

Ø 50 mm

1177-SCRIBE OFFSET SCRIBER 230mm

BE-3529 O-RING LEVER

175 mm

1150-1/2H/P CALIPER

150 mm



FF3A03 - 12 pcs

2101GC-160IP SIDE CUTTING PLIER, ERGO™

160 mm

2421GC-180IP FLAT NOSE PLIER

180 mm

2855D WIRE TWISTING PLIER

282 mm

8224CIP SLIP JOINT PLIER, ERGO™

MTB-3-16 MEASURING TAPE

3 m

3658A DRIFT PUNCHES WITH HAND PROTECTION

2x150, 3x150, 5x150 mm

BFLB01 Q3 LED TORCH

454800500 ALUMINUM DRIFT PUNCH

25 X 150 mm hhw

1151-1 TYRE PROFILEMETER

30 mm hhw

1151-2 PROFILEMETER

80 mm



FF3A04 - 20 pcs

8158-1/2 BREAKER BAR

380 mm

1300Z DOUBLE RING END WRENCH, OFFSET

1/4X5/16", 3/8X7/16", 1/2X9/16", 19/32X11/16", 5/8X3/4",

25/32X13/16", 7/8X15/16"

1931Z LILIPUT DOUBLE OPEN-END WRENCHES

7/32", 1/4"

6Z DOUBLE OPEN-END WRENCHES

1/4X5/16", 3/8X7/16", 1/2X9/16", 19/32X11/16", 5/8X3/4",

25/32X13/16"

9070C ADJUSTABLE WRENCH CHROMED 6" ERGO™

158x20 mm

XID1618A DOUBLE RING WRENCH

1/4x9/32"

XID1514A DOUBLE RING WRENCH WRENCH

7/32x15/64"

DS2018A BOXCKET

5/16x9/32"



METALLIC CASES COMPOSITIONS

■ 1483KHD3RB-FF2

152 PCS

- Aviation Mechanics, suitable for all large airplanes
- Hardware: 1483KHD3RB. Heavy Duty Rigid Case without wheels
- Especially for line maintenance
- Inch
- Sizes: 1/4; 3/8



ERGO TOOL MANAGEMENT SYSTEM



LID ASSORTMENT - 5 pcs

481-400 DIN HAMMER

400 mm

3625N-35 PLASTIC HAMMER

2509 FLEXIBLE PICK-UP TOOL

525 mm

2535F2 MAGNETIC PICK-UP TOOL

1 kg

7762 EXTENSION BAR 3/8"

250 mm



FF3A05 - 98 pcs

6950SL REVERSIBLE RATCHET 1/4", SLIMHEAD

7750SL RATCHET 3/8" SLIMHEAD

6960 / 6962 EXTENSION BARS 1/4"

50, 150 mm

7760 / 7761 EXTENSION BARS 3/8"

75, 125 mm

6956 SPINNER HANDLE 1/4"

7752 SPEEDER 3/8"

6966 UNIVERSAL JOINT 1/4"

7766 UNIVERSAL JOINT 3/8"

7764 ADAPTOR F 3/8" - M 1/4"

7765 ADAPTOR F 1/4" - M 3/8"

8164-1/2 ADAPTOR F 3/8" - M 1/2"

6972H BIT HOLDER 1/4"

7407H BIT HOLDER 3/8"

1/4" - 3/8"

A6700DZ SOCKET 1/4", BI-HEX, AEROSPACE SHORT SERIES

3/16", 7/32", 1/4", 9/32", 5/16", 11/32", 3/8", 7/16", 1/2", 9/16"

A6710DZ SWIVEL SOCKETS 1/4",

BI-HEX, AEROSPACE

1/4", 5/16", 11/32", 3/8", 7/16"

A6800M-4 SOCKET 1/4", BI-HEX LONG SERIES

4 mm

A6800DZ SOCKETS 1/4" BI-HEX, AEROSPACE LONG SERIES

1/4", 9/32", 5/16", 3/8", 11/32", 7/16", 1/2", 9/16", 3/16", 7/32"

A7400DZ SOCKETS 3/8" BI-HEX, AEROSPACE SHORT SERIES

3/8", 7/16", 1/2", 17/32", 9/16", 19/32", 5/8", 11/16", 3/4", 13/16", 17/32"

BE-9780 BLACK HEX KEYS SET,

LONG BALL END, 12 PCS

0.050", 1/16", 5/64", 3/32", 7/64", 1/8", 9/64", 5/32", 3/16", 7/32", 1/4", 5/16"

59/S28-4 BITS SET FOR SLOTTED, PHILLIPS, TORX®,

HEXAGON AND TORQ-SET® HEAD SCREWS

28 PCS

9071C ADJUSTABLE WRENCH CHROMED 8" ERGO™

808050 RATCHETING BIT SCREWDRIVER

2058-BR BIT-RATCHET 1/4"

1544 FEELER GAUGE

KE18-01 ERGO™ KNIFE

70S/T51/4 BIT TORQ-SET

1/4 32 mm 5/16



1483KCART



METALLIC CASES COMPOSITIONS

■ 1483KHD3RB-FF2

152 PCS

- Aviation Mechanics, suitable for all large airplanes
- Hardware: 1483KHD3RB. Heavy Duty Rigid Case without wheels
- Especially for line maintenance
- Inch
- Sizes: 1/4; 3/8



ERGO TOOL MANAGEMENT SYSTEM



FF3A06 - 15 pcs

2047-1-5.5 DOUBLE OFFSET KEY FOR SLOTTED SCREWS

1X5, 5X125 mm

2047PR-1-2 DOUBLE OFFSET KEY FOR PHILLIPS SCREWS

PH 1-2

BE-8030 SCREWDRIVER ERGO™

SLOTTED

0.6X3,5X75

BE-8155 SCREWDRIVER ERGO™

SLOTTED

1.2X6,5X125

BE-8150 SCREWDRIVERS ERGO™ SLOTTED

1,0X5, 5X100 mm

BE-8260 SCREWDRIVER ERGO™

SLOTTED, HEX PROFILE & BOLSTER

1,6X8,0X175

BE-8350 SCREWDRIVER ERGO™

SLOTTED, STUBBY

1X5,5X25

BE-8602 SCREWDRIVER ERGO™, PHILLIPS, STUBBY

PH2X25

BE-8610 / BE-8620 SCREWDRIVERS ERGO™ PHILLIPS

PH1X75, PH2X100

5515T-52 TELESCOPIC SWIVEL HEAD MIRROR

Ø 50 mm

1177-SCRIBE OFFSET SCRIBER 230mm

1179-FLX-2 FLEXIBLE MEASUR. ROD

300 mm

704Z-3/32 PRECISION HEX BALL SCREWDRIVER

3/32X75

1150-1/2H/P CALIPER 150MM



FF3A07 - 11 pcs

MTB-3-16 MEASURING TAPE

3 m

2101GC-160IP SIDE CUTTING PLIER, ERGO™

160 mm

2427 GC-200IP LONG, ROUND NOSE CHROMED PLIER,

ERGO™

200 mm

2855 WIRE TWISTING PLIER

224 mm

8224CIP SLIP JOINT PLIER, ERGO™

2650 SLIP JOINT, CONNECTOR PLIER

2628 GC-160IP COMBINATION CHROMED PLIER, ERGO™

160 mm

2632 COMBINATION COTTER PIN EXTRACTOR AND

SPREADER

170 mm

3734 DRIFT PUNCHES

Ø 3, 5, 8 mm



FF3A08 - 23 pcs

1320RZ RATCHETING RING WRENCHES

1/4X5/16", 3/8X7/16", 1/2X9/16", 5/16X11/32"

6Z DOUBLE OPEN-END WRENCHES

1/4X5/16", 5/16X11/32", 3/8X7/16", 1/2X9/16",
19/32X11/16", 5/8X3/4", 13/16X7/8"

1952Z COMBINATION WRENCH

1/4", 5/16", 11/32", 3/8", 7/16", 1/2", 9/16", 5/8", 11/16,
3/4", 13/16", 7/8"



METALLIC CASES COMPOSITIONS

■ 1483KHD3RB-FF3

193 PCS

- General Purpose
- Hardware: 1483KHD3RB. Heavy Duty Rigid Case without wheels
- Metric
- Sizes: 1/4



ERGO TOOL MANAGEMENT SYSTEM



LID ASSORTMENT - 5 pcs

481-300 DIN HAMMER

300 mm

3625N-32 PLASTIC HAMMER

2509 FLEXIBLE PICK-UP TOOL

525 mm

2535F2 MAGNETIC PICK-UP TOOL

1 kg

7762 EXTENSION BAR 3/8"

250 mm



FF3A09 - 95 pcs

6700SM SOCKET 1/4", AEROSPACE, SHORT SERIES

5.5, 6, 7, 8, 9, 10, 11, 12, 13

A6800DM SOCKET 1/4", AEROSPACE LONG SERIES

5.5, 6, 7, 8, 9, 10, 11, 12, 13

6709M SOCKET DRIVER 1/4", HEX

3, 4, 5, 6, 8

6709PH SOCKET DRIVER 1/4", PH

1, 2, 3

6709TORX SOCKET DRIVER 1/4", TORX®

T8, T9, T10, T15, T20, T25, T27, T30, T40

6950SL REVERSIBLE RATCHET 1/4", SLIMHEAD

6954 T-HANDLE 1/4"

6956 SPINNER HANDLE 1/4"

6958 BREAKER BAR 1/4"

6960 / 6961 / 6962 / 6962L EXTENSION BARS 1/4"

50, 100, 150, 355 mm

6966 UNIVERSAL JOINT 1/4"

6972H BIT HOLDER 1/4"

7764 ADAPTOR F 3/8" - M 1/4"

7400SM SOCKET 3/8", SHORT SERIES

6, 7, 8, 9, 10, 11, 12, 13, 14, 15, 16, 17, 18, 19, 22

A7402DM SOCKET 3/8", AEROSPACE LONG SERIES

10, 11, 12, 13, 14, 15, 16, 17, 18, 19

7409M SOCKET DRIVER 3/8" HEX,

3, 4, 5, 6, 7, 8, 10

7409TORX SOCKET DRIVER 3/8", TORX®

T25, T27, T30, T40, T45, T50

7750SL RATCHET 3/8" SLIMHEAD

7754 T-HANDLE 3/8"

7758 BREAKER BAR 3/8"

7760 / 7761

EXTENSION BARS 3/8" 75, 125 mm

7766 UNIVERSAL JOINT 3/8"

7765 ADAPTOR F 1/4" - M 3/8"

8164-1/2 ADAPTOR F 3/8" - M 1/2"

7407H SOCKET HOLDER 3/8"

1/4" - 3/8"

2058-BR BIT-RATCHET 1/4"

1544 FEELER GAUGE



1483KCART



METALLIC CASES COMPOSITIONS

■ 1483KHD3RB-FF3

193 PCS

- General Purpose
- Hardware: 1483KHD3RB. Heavy Duty Rigid Case without wheels
- Metric
- Sizes: 1/4



ERGO TOOL MANAGEMENT SYSTEM



FF3A10 - 53 pcs

808050S RATCHETING SCREWDRIVER, STUBBY

808050P PISTOL HANDLE RATCHETING SCREWDRIVER

59S/31-1 BITS SET

31 PCS: PH, PZ, TORX®, HEX, SL

2047-0.8-4 OFFSET SCREWDRIVER

0.8X4X100

2047PR-1-2 DOUBLE OFFSET KEY FOR PHILLIPS SCREWS

PH1 & 2

BE-8020L SCREWDRIVER ERGO™, SLOTTED

0.5X3X75

BE-8030 SCREWDRIVER ERGO™

SLOTTED

0.6X3.5X75

BE-8155 SCREWDRIVER ERGO™

SLOTTED

1.2X6.5X125

BE-8260 SCREWDRIVER ERGO™

SLOTTED, HEX PROFILE & BOLSTER

1.6X8.0X175

BE-8350 SCREWDRIVER ERGO™

SLOTTED, STUBBY

1X5.5X25

BE-8601 / BE-8602 SCREWDRIVERS ERGO™, PHILLIPS,

STUBBY

PH1X25, PH2X25

BE-8610 / BE-8620 SCREWDRIVERS ERGO™, PHILLIPS

PH1X75, PH2X100

BE-9770 BLACK HEX KEYS SET, LONG BALL END, 9 PCS

HEX 1.5, 2, 2.5, 3, 4, 5, 6, 8, 10



FF3A11 - 12 pcs

21016C SIDE CUTTER ERGO™

160 mm

2427 GC-200IP LONG, ROUND NOSE CHROMED PLIER, ERGO™

200 mm

2430 GC-200 IP SNIPE NOSE CHROMED PLIER, ERGO™

200 mm

2628 GC-160IP COMBINATION CHROMED PLIER, ERGO™

160 mm

8224CIP SLIP JOINT PLIER, ERGO™

3734 DRIFT PUNCHES

Ø 3, 5, 8 mm

3735-4-120 CENTRE PUNCH

120 mm

1177-SCRIBE OFFSET SCRIBER 230mm

1150-1/2H/P CALIPER

150 mm

MTB-3-16 MEASURING TAPE

3 m



FF3A12 - 28 pcs

111M COMBINATION WRENCH

6, 7, 8, 9, 10, 11, 12, 13, 14, 15, 16, 17, 18, 19, 21, 22

6M OPEN END WRENCH

6x7, 8x9, 10x11, 12x13, 14x15, 16x17, 18x19, 20x22

9070C ADJUSTABLE WRENCH CHROMED 6" ERGO™

158x20 mm

5515T-52 TELESCOPIC SWIVEL HEAD MIRROR

Ø 50 mm

2820EF2 ELECTRICIANS KNIFE

BFLA01 SUPRABEAM Q3 LED-TORCH



METALLIC CASES COMPOSITIONS

■ 1483KHD3RB-FF4

146 PCS

- General Purpose
- Hardware: 1483KHD3RB. Heavy Duty Rigid Case without wheels
- Metric
- Sizes: 1/2



ERGO TOOL MANAGEMENT SYSTEM



LID ASSORTMENT - 4 pcs

481-500 DIN HAMMER

500 mm

3625N-32 PLASTIC HAMMER

2509 FLEXIBLE PICK-UP TOOL

525 mm

2535F2 MAGNETIC PICK-UP TOOL

1 kg



FF3A13 - 49 pcs

7800SM SOCKET 1/2" SHORT SERIES 10, 11, 12, 13, 14, 15,

16, 17, 18, 19, 21, 22, 24, 27, 30, 32

7809M SOCKET DRIVER 1/2", HEX

5, 6, 7, 8, 10, 12, 14, 17, 19

7809TORX SOCKET DRIVER 1/2", TORX®

T20, T25, T27, T30, T40, T45, T50, T55, T60

8154-1/2 T-HANDLE 1/2"

8150SL RATCHET 1/2", SLIMHEAD

8160-1/2 EXTENSION BAR 1/2",

125 mm

8162-1/2 EXTENSION BAR 1/2"

250 mm

8164-1/2 ADAPTOR F 3/8" - M 1/2"

8166-1/2 UNIVERSAL JOINT 1/2"

8165-1/2 ADAPTOR F 1/2" - M 3/8"

8964 ADAPTOR F 1/2" - M 3/4"

7807H SOCKET HOLDER 1/2"

111M COMBINATION WRENCH

24, 27, 30, 32

6M OPEN END WRENCH

24x27, 30x32



FF3A10 - 53 pcs

808050P PISTOL HANDLE RATCHETING SCREWDRIVER

808050S RATCHETING SCREWDRIVER, STUBBY

59S/31-1 BIT-SET

PH, PZ, TORX®, SL

2047-0.8-4 OFFSET SCREWDRIVER

0.8X4X100

2047PR-1-2 DOUBLE OFFSET KEY FOR PHILLIPS SCREWS

PH1 & 2

BE-8020L SCREWDRIVER ERGO™, SLOTTED

0.5X3X75

BE-8030 SCREWDRIVER ERGO™

SLOTTED

0.6X3,5X75

BE-8155 SCREWDRIVER ERGO™,

SLOTTED

1,2X6,5X125

BE-8260 SCREWDRIVER ERGO™

SLOTTED, HEX PROFILE & BOLSTER

1,6X8,0X175

BE-8350 SCREWDRIVER ERGO™

SLOTTED, STUBBY

1X5,5X25

BE-8601 / BE-8602 SCREWDRIVERS ERGO™, PHILLIPS,

STUBBY

PH1X25, PH2X25

BE-8610 / BE-8620 SCREWDRIVERS ERGO™, PHILLIPS

PH1X75, PH2X100

BE-9770 BLACK HEX KEYS SET, LONG BALL END, 9 PCS

HEX 1.5, 2, 2.5, 3, 4, 5, 6, 8, 10



1483KCART



METALLIC CASES COMPOSITIONS

■ 1483KHD3RB-FF4

146 PCS

- General Purpose
- Hardware: 1483KHD3RB. Heavy Duty Rigid Case without wheels
- Metric
- Sizes: 1/2



ERGO TOOL MANAGEMENT SYSTEM



FF3A11 - 12 pcs

MTB-3-16 MEASURING TAPE

3 m

21016C SIDE CUTTER ERGO™

160 mm

2427 GC-200IP LONG, ROUND NOSE CHROMED PLIER, ERGO™

200 mm

2430 GC-200 IP SNIPE NOSE CHROMED PLIER, ERGO™

200 mm

2628 GC-160IP COMBINATION CHROMED PLIER, ERGO™

160 mm

8224CIP SLIP JOINT PLIER, ERGO™

3734 DRIFT PUNCHES

Ø 3, 5, 8 mm

3735-4-120 CENTRE PUNCH

120 mm

1177-SCRIBE OFFSET SCRIBER 230mm

1150-1/2H/P CALIPER

150 mm



FF3A12 - 28 pcs

111M COMBINATION WRENCH

6, 7, 8, 9, 10, 11, 12, 13, 14, 15, 16, 17, 18, 19, 21, 22

6M OPEN END WRENCH

6x7, 8x9, 10x11, 12x13, 14x15, 16x17, 18x19, 20x22

9070C ADJUSTABLE WRENCH CHROMED 6" ERGO™

158x20 mm

5515T-52 TELESCOPIC SWIVEL HEAD MIRROR

Ø 50 mm

2820EF2 ELECTRICIANS KNIFE

BFLA01 Q3 LED-TORCH



METALLIC CASES COMPOSITIONS

■ 1483KHD3RB-FF5

137 PCS

- Aviation Mechanics, suitable for all airplanes
- Hardware: 1483KHD3RB. Heavy Duty Rigid Case without wheels
- Especially for line maintenance
- Inch
- Sizes: 1/4; 3/8



ERGO TOOL MANAGEMENT SYSTEM



LID ASSORTMENT - 4 pcs

481-500 DIN HAMMER

500 mm

3625N-32 PLASTIC HAMMER

2509 FLEXIBLE PICK-UP TOOL

525 mm

7762 EXTENSION BAR 3/8"

250 mm



FF3A14 - 77 pcs

111Z COMBINATION WRENCHES

1", 1.1/8"

6Z/8C SET OF DOUBLE OPEN-END WRENCHES

1/4x5/16", 5/16x11/32", 3/8x7/16", 1/2x9/16",
19/32x11/16", 5/8x3/4", 13/16x7/8", 15/16x1"

6Z DOUBLE OPEN-END WRENCHES

1x1.1/8", 1.1/16x1.1/4"

6950SL REVERSIBLE RATCHET 1/4", SLIMHEAD

6960 / 6961 EXTENSION BARS 1/4"

50, 100 mm

6958 BREAKER BAR 1/4"

6966 UNIVERSAL JOINT 1/4"

7750SL RATCHET 3/8" SLIMHEAD

7752 SPEEDER 3/8"

7766 UNIVERSAL JOINT 3/8"

7760 / 7761 EXTENSION BARS 3/8" 5, 125 mm

7764 ADAPTOR F 3/8" - M 1/4"

7765 ADAPTOR F 1/4" - M 3/8"

8164-1/2 ADAPTOR F 3/8" - M 1/2"

8165-1/2 ADAPTOR F 1/2" - M 3/8"

6972H BIT HOLDER 1/4"

7407H BIT HOLDER 3/8"

1/4" - 3/8"

7408H BIT HOLDER 3/8"

5/16" - 3/8"

A6700DZ SOCKET 1/4", BI-HEX, AEROSPACE

7/32", 1/4", 9/32", 5/16", 11/32", 3/8", 7/16", 1/2", 9/16"

A6800DZ SOCKETS 1/4" BI-HEX, AEROSPACE

7/32", 1/4", 9/32", 5/16"

A7400DM SOCKETS 3/8", BI-HEX, AEROSPACE SHORT

SERIES 10, 13 mm

A7402DZ SOCKETS 3/8", BI-HEX, LONG SERIES, AEROSPACE

3/8", 7/16", 1/2", 9/16"

7800DZ SOCKETS 1/2", BI-HEX

15/16", 1"

59/S28-4 BITS SET FOR SLOTTED, PHILLIPS, TORX®,

HEXAGON AND TORQ-SET® HEAD SCREWS

28 PCS



1483KCART



METALLIC CASES COMPOSITIONS

■ 1483KHD3RB-FF5

137 PCS

- Aviation Mechanics, suitable for all airplanes
- Hardware: 1483KHD3RB. Heavy Duty Rigid Case without wheels
- Especially for line maintenance
- Inch
- Sizes: 1/4; 3/8



ERGO TOOL MANAGEMENT SYSTEM



FF3A15 - 14 pcs

1179-FLX-2 FLEXIBLE MEASUR. ROD

300 mm

20471.2-8 OFFSET SCREWDRIVER

0,8X4X100

2047PR-1-2 DOUBLE OFFSET KEY FOR PHILLIPS SCREWS

PH1 & 2

BE-8020L SCREWDRIVER ERGO™, SLOTTED

0,5X3X75

BE-8155 SCREWDRIVER ERGO™,

SLOTTED

1,2X6,5X125

BE-8260 SCREWDRIVER ERGO™

SLOTTED, HEX PROFILE & BOLSTER

1,6X8,0X175

9715-14-250 THROUGH BLADE SCREWDRIVER

2,5x14x250

BE-8601 / BE-8602 SCREWDRIVERS ERGO™, PHILLIPS,

STUBBY

PH1X25, PH2X25

BE-8611 / BE-8621 SCREWDRIVERS ERGO™, PHILLIPS

PH1X75, PH2X100

1177-SCRIBE OFFSET SCRIBER 230mm

5515T-52 TELESCOPIC SWIVEL HEAD MIRROR

Ø 50 mm

BE-3529 O-RING LEVER

175 mm



FF3A16 - 12 pcs

2101GC-160IP SIDE CUTTING PLIER, ERGO™

160 mm

2421GC-180IP FLAT NOSE PLIER

180 mm

2855 D WIRE TWISTING PLIER

282 mm

MTB-3-16-E MEASURING TAPE

3 m

3658A DRIFT PUNCHES WITH HAND PROTECTION

3x150, 5x150, 8x150 mm

8224CIP SLIP JOINT PLIER, ERGO™

BFLB01 Q3 LED TORCH

454800500 ALUMINUM DRIFT PUNCH

25 X 150 mm hhw

3740-150 FLAT CHISEL

150 mm

3735-4-120 CENTRE PUNCH

120 mm



FF3A17 - 30 pcs

DS2018A DOUBLE OPEN-ENDED SPANNER

5/16" X9/32"

BE-9780 BLACK HEX KEYS SET,

LONG BALL END, 12 PCS

0.050", 1/16", 5/64", 3/32", 7/64", 1/8", 9/64", 5/32", 3/16",

7/32", 1/4", 5/16"

1320RZ RATCHETING RING WRENCHES

1/4X5/16", 3/8X7/16"

1952Z COMBINATION WRENCH

11/32", 1/2", 9/16", 5/8", 11/16", 3/4", 13/16", 7/8"

2628 GC-180IP COMBINATION CHROMED PLIER, ERGO™

180 mm

KE18-01 CUTTER KNIFE ERGO™

7758 BREAKER BAR 3/8"

1300Z DOUBLE RING END WRENCH, OFFSET

1/4X5/16", 3/8X7/16"

1931Z LILIPUT DOUBLE OPEN-END WRENCHES

7/32", 1/4"



AUTO REPAIR EXTRA LARGE COMPOSITION

1470K7FFAUTO

TROLLEY AND 7 DRAWERS FILLED COMPOSITION

- Trolley and 7 drawers Extra Large composition including:
 - 1/4; 3/8 and 1/2 socket drivers
 - Combination and ring end wrenches
 - Slotted, PH, PZ and TORX screwdrivers
- Suitable for all vehicle garages
- It comes with the 1470K7 orange trolley



7DR TROLLEY-FILLED AUTO

111M COMBINATION WRENCH 10, 11, 12, 13, 14, 15, 16, 17, 18, 19, 20, 21, 22, 24, 27, 30, 32 mm

1419-MD MAGNETIC DISH

208 HACKSAW FRAMES

2101G-160IP SIDE CUTTER 160 mm

2430 G-160 IP SNIPE NOSE CUTTING 160 mm

2444 CARPENTERS KNIFE

2509 FLEXIBLE PICK UP

2628 G-180IP COMBINATION PLIER 180 mm

268 MINIHACKSAW FRAMES

2744 MULTI-PURPOSE SNIP

2M RING WRENCH 6-7, 8-9, 10-11, 12-13, 14-15, 16-17, 18-19, 20-22, 21-23, 24-27, 25-28, 30-32 mm

319-3906 HACKSAW FRAME 319

3625N-35 PLASTIC HAMMER

3734 COTTER PIN PUNCH 2, 3, 4, 5, 6, 8 mm

3735-5-120 CENTER PUNCH

3740-175 FLAT CHISEL

4040M-10-11 FLEX HEAD SPANNER 8-9, 10-11, 12-13, 14-15, 16-17, 18-19, 20-22, 21-23 mm

481-400 GERMAN DIN-HAMMER

5515T TELESCOPIC MIRROR

59S/31-1 PZ1, PZ2 (x3), PZ3; PH1, PH2 (x3), PH3; PH2G (x2); T10, T15 (x3), T20 (x3), T25 (x2), T27, T30. SL: 3, 4, 5, 5.5mm; HEX: 3mm, 4, 5, 6mm. 1/4" Magnetic bit holder.

6700SM SOCKET 1/4 4, 4.5, 5, 5.5, 6, 7, 8, 8, 10, 11, 12, 13, 14

6950 RATCHET 1/4, PEAR TYPE 72T

6954 T-HANDLE

6956 SPINNER HANDLE 1/4

6960 EXTENSION 1/4 50 mm

6962 EXTENSION 1/4 150 mm

6966 UNIVERSAL JOINT 1/4

7400SM SOCKET 3/8 6, 7, 8, 9, 10, 11, 12, 13, 14, 15, 16, 17, 18, 19, 20, 21, 22 mm

7754 T-HANDLE 3/8

7755-3/8 RATCHET 3/8

7760 EXTENSION 3/8, 75 mm

7761 EXTENSION 3/8, 125 mm

7762 EXTENSION 3/8, 250 mm

7766 UNIVERSAL JOINT 3/8

7800SM SOCKET 1/2 8, 9, 10, 11, 12, 13, 14, 15, 16, 17, 18, 19, 20, 21, 22, 23, 24, 26, 27, 28, 30, 32 mm

7805DM 1/2IN DEEP SOCKET 10, 12, 13, 17, 19 mm

7809M SOCKET DRIVER 1/2, HEX 5, 6, 7, 8, 9 10, 12, 14, 17, 19 mm

7809M-10-140 SOCKET DRIVER 1/2 HEX.LONG

7809M-5-180 SOCKET DRIVER 1/2 HEX.LONG

7809M-6-140 SOCKET DRIVER 1/2 HEX.LONG

7809M-7-100 SOCKET DRIVER 1/2 HEX.LONG

7809M-8-120 SOCKET DRIVER 1/2 HEX.LONG

7809TORX-T25 SOCKET 1/2 T25, 30, 40, 45, 50, 55 mm

808050 RATCHETING BIT SCREWDRIVER

8154-1/2 T HANDLE

8155-1/2 RATCHET 1/2

8160-1/2 EXTENSION 125 mm

8162-1/2 EXTENSION 250 mm

8166-1/2 UNIVERSAL JOINT 1/2

8224 IP SLIP JOINT PLIER 250 mm

BBR201P6 XZN 1/2 IMP SOCK BIT- BRAKE 6P

BE5103 XZN 1/2 SOCKET W/BIT-ENG 9P

BE-8020L SCREWDRIVER ERGO 0,5X3X75

BE-8040 SCREWDRIVER ERGO 0,8X4,0X100

BE-8150 SCREWDRIVER ERGO 1,0X5,5X100

BE-8255 SCREWDRIVER ERGO 1,2X6,5X150

BE-8256 SCREWDRIVER ERGO 1,6X8,0X150

BE-8340 SCREWDRIVER ERGO 0,8X4X25

BE-8601 SCREWDRIVER ERGO PH1X25

BE-8610 SCREWDRIVER ERGO PH1X75

BE-8620 SCREWDRIVER ERGO PH2X100

BE-8906 SCREWDRIVER ERGO TX 6X75

BE-8907 SCREWDRIVER ERGO TX 7X75

BE-8908 SCREWDRIVER ERGO TX 8X75

BE-8909 SCREWDRIVER ERGO TX 9X75

BE-8910 SCREWDRIVER ERGO TX 10X75

BE-8915 SCREWDRIVER ERGO TX 15X100

BE-8920 SCREWDRIVER ERGO TX 20X100

BE-8925 SCREWDRIVER ERGO TX 25X125

BE-8927 SCREWDRIVER ERGO TX 27X125

BE-8930 SCREWDRIVER ERGO TX 30X150

BE-8940 SCREWDRIVER ERGOTX 40X150

BE-8945 SCREWDRIVER ERGO TX 45X150

BE-9678 BLACK KEYS SETS FOR HEX SCREWS, LONG BALL END 1.5, 2, 2.5, 3, 4, 5, 6, 8, 10 mm

MTB-5-25 5M TAPE MEASURE 25 mm



AUTO REPAIR LARGE COMPOSITION

FF1ASET-AUTO1

5 DRAWERS FILLED COMPOSITION. 196 TOOLS

- 5 inlays Large composition including:
 - 1/4 and 1/2 socket drivers
 - Combination and ring end wrenches
 - Slotted, PH and TORX screwdrivers
- Suitable for all vehicle garages
- Compatible with all trolleys



ERGO TOOL MANAGEMENT SYSTEM



AUTO LARGE COMPOSITION

2M DOUBLE END BOX SPANNER 6-7, 8-9, 10-11, 12-13, 14-15, 16-17, 18-19, 20-22, 21-23, 24-27, 30-32

111M COMBINATION WRENCH 6, 7, 8, 9, 10, 11, 12, 13, 14, 15, 16, 17, 18, 19, 21, 22, 24, 27, 30, 32 mm

4040M FLEX HEAD WRENCH 10-11, 12-13, 14-15, 16-17, 18-19, 21-23

7800SM SOCKET 1/2 10, 12, 13, 14, 15, 16, 17, 18, 19, 20, 21, 22, 23, 24, 27, 30, 32 mm

7805SM SOCKET DEEP 1/2" 13, 16, 17, 18, 19, 21, 22, 24, 27, 30, 32 mm

7809M-5 SOCKET DRIVER 1/2, HEX 5, 6, 8, 10, 12, 14

8158-1/2 BREAKER BAR 400 MM 1/2

8154-1/2 SLIDING T-HANDLE 1/2

8159-1/2 EXTENSION BAR 1/2-75 mm

8160-1/2 EXTENSION BAR 1/2-125 mm

8166-1/2 UNIVERSAL JOINT 1/2

8150SL REVERSIBLE RATCHET 1/2

6700SM SOCKET 1/4 4, 4.5, 5, 5.5, 6, 7, 8, 9, 10, 11, 12, 13 mm

6958 BREAKER BAR 1/4"

6954 T-HANDLE 1/4

6960 EXTENSION BAR 1/4 -50 mm

6962 EXTENSION BAR 1/4 -150 mm

6966 UNIVERSAL JOINT 1/4"

59S/31-1 PZ1, PZ2 (x3), PZ3; PH1, PH2 (x3), PH3; PH2G (x2); T10, T15 (x3), T20 (x3), T25 (x2), T27, T30. SL: 3, 4, 5, 5.5mm; HEX: 3mm, 4, 5, 6mm. 1/4" Magnetic bit holder.

6950SL PEAR TYPE RATCHET 1/4"

3735-4-120 CENTRE PUNCH

3734 COTTER PIN PUNCH 2, 3, 4, 5, 6, 8 mm

3734 COTTER PIN PUNCH 2, 3, 4, 5, 6, 8 mm

SCREWDRIVER ERGO 8X175

BE-8255 SCREWDRIVER ERGO 6,5X150

BE-8242 SCREWDRIVER ERGO 5,5X125

BE-8040 SCREWDRIVER ERGO 4X100

BE-8030 SCREWDRIVER ERGO 3,5X75

BE-8611 SCREWDRIVER ERGO PH 1X100

BE-8620 SCREWDRIVER ERGOPH 2X125

BE-8910 SCREWDRIVER ERGO TORX T-10X75

BE-8915 SCREWDRIVER ERGO TORX T-15X100

BE-8920 SCREWDRIVER ERGO TORX T-20X100

BE-8925 SCREWDRIVER ERGO TORX T-25X125

BE-8927 SCREWDRIVER ERGO TORX T-27X125

BE-8930 SCREWDRIVER ERGOTORX T-30X150

BE-8940 SCREWDRIVER ERGOTORX T-40X150

BE-8577 BIT HOLDER 1/4"

BE-8355 SCRWD FLAT STUBBY 6,5X25

BE-8602 SCRWD PH 2X25

2630G-180IP COMBINATION PLIER 180 mm

2430 G-200 SNIPE NOSE CUTTING 200 mm

2427 G-200 SNIPE NOSE BENT 200 mm

2900-180 CIRCLIP PLIER 2900-180

2890-180 CIRCLIP PLIER 2890-180

2990-180 CIRCLIP PLIER 2990-180

2800-180 CIRCLIP PLIER 2800-180

7224 SLIP JOINT PLIER 2971G-250

2953-250 UNIV.LOCKING CURVED PLIER 250

2101G-160IP SIDE CUTTER 160 mm

479-16 BALL PEIN HAMMER

3625N-35 PLASTIC HAMMER

1547 FEELER GAUGED,05-1 20BLADE

4532-A UNIV. TWO-ARM PULLER

2446 STAINLESS STEEL CARPENTER KNIF

MTB-3-16 3M TAPE MEASURE 16MM CARDED

SC127 ELECTRICIAN'S SCISSORS 127MM

9070 ADJUSTABLE WRENCH 8070 6"

BE-9678 BLACK KEYS SETS FOR HEX SCREWS, LONG BALL END 1.5, 2, 2.5, 3, 4, 5, 6, 8, 10

BE-9575 BLACK KEYS SETS FOR TORX SCREWS, LONG BALL END T9, 10, 15, 20, 25, 27, 30, 40



AUTO REPAIR MEDIUM COMPOSITION

■ FF1ASET-AUTO2

4 DRAWERS FILLED COMPOSITION. 168 TOOLS

- 4 inlays Medium composition including:
 - 1/4 and 1/2 socket drivers
 - Combination wrenches
 - Slotted, PH and TORX screwdrivers
- Suitable for all vehicle garages
- Compatible with all trolleys



ERGO TOOL MANAGEMENT SYSTEM



AUTO MEDIUM COMPOSITION

111M COMBINATION WRENCH 6, 7, 8, 9, 10, 11, 12, 13, 14, 15, 16, 17, 18, 19, 21, 22, 24, 27, 30, 32 mm

7800SM SOCKET 1/2 10, 12, 13, 14, 15, 16, 17, 18, 19, 20, 21, 22, 23, 24, 27, 30, 32 mm

8154-1/2 T-HANDLE

8159-1/2 EXTENSION

8160-1/2 EXTENSION

8166-1/2 UNIVERSAL JOINT

8150SL RATCHET 1/2, SLIM HEAD 72T

6700SM-4 SOCKET 1/4 4, 4.5, 5, 5.5, 6, 7, 8, 9, 10, 11, 12, 13 mm

6954 T-HANDLE

6960 EXTENSION 1/4

6962 EXTENSION 1/4

6966 UNIVERSAL JOINT

59S/31-1 PZ1, PZ2 (x3), PZ3; PH1, PH2 (x3), PH3; PH2G (x2); T10, T15 (x3), T20 (x3), T25 (x2), T27, T30. SL: 3, 4.5, 5.5mm; HEX: 3mm, 4, 5, 6mm. 1/4 " Magnetic bit holder.

6950SL RATCHET 1/4, SLIM HEAD 72T

3735-4-120 CENTRE PUNCH

3734 COTTER PIN PUNCH 2, 3, 4, 5, 6, 8 mm

BE-8257 SCREWDRIVER ERGO 1,6X8,0X175

BE-8255 SCREWDRIVER ERGO 1,2X6,5X150

BE-8242 SCREWDRIVER ERGO 1,0X5,5X150

BE-8040 SCREWDRIVER ERGO 0,8X4,0X100

BE-8030 SCREWDRIVER ERGO 0,6X3,5X75

BE-8611 SCREWDRIVER ERGO PH1X75

BE-8620 SCREWDRIVER ERGO PH2X100

BE-8910 SCREWDRIVER ERGO TX 10X75

BE-8915 SCREWDRIVER ERGO TX 15X100

BE-8920 SCREWDRIVER ERGO TX 20X100

BE-8925 SCREWDRIVER ERGO TX 25X125

BE-8927 SCREWDRIVER ERGO TX 27X125

BE-8930 SCREWDRIVER ERGO TX 30X150

BE-8940 SCREWDRIVER ERGO TX 40X150

BE-8577 SCREWDRIVER ERGO 1/4 BIT HOLDER

BE-8355 SCREWDRIVER ERGO 1,2X6,5X25

BE-8602 SCREWDRIVER ERGO PH2X25

2630D-180 COMBINATION PLIER 180 mm

2430 G-200 IP SNIPE NOSE CUTTING 200 mm

7224 SLIP JOINT PLIER 250 mm

2953-250 UNIVERSAL LOCKING CURVED PLIER 250 mm

2101G-160IP SIDE CUTTER 160 mm

479-16 BALL PEIN HAMMER

3625N-35 PLASTIC HAMMER

MTB-3-16 3M TAPE MEASURE 16MM

SC127 ELECTRICIAN'S SCISSORS 127MM

BE-9678 BLACK KEYS SETS FOR HEX SCREWS, LONG BALL END 1.5, 2, 2.5, 3, 4, 5, 6, 8, 10

BE-9575 BLACK KEYS SETS FOR TORX SCREWS, LONG BALL END T9, 10, 15, 20, 25, 27, 30, 40



AUTO REPAIR SMALL COMPOSITION

■ FF1ASET-AUTO3

3 DRAWERS FILLED COMPOSITION. 140 TOOLS

- 4 inlays Small composition including:
 - 1/4 and 1/2 socket drivers
 - Combination wrenches
 - Slotted, PH and TORX screwdrivers
- Suitable for all vehicle garages
- Compatible with all trolleys



AUTO SMALL COMPOSITION

111M COMBINATION WRENCH 6, 7, 8, 9, 10, 11, 12, 13, 14, 15, 16, 17, 18, 19, 21, 22, 24, 27, 30, 32 mm

7800SM SOCKET 1/2 10, 12, 13, 14, 15, 16, 17, 18, 19, 20, 21, 22, 23, 24, 27, 30, 32 mm

8154-1/2 T-HANDLE

8159-1/2 EXTENSION

8160-1/2 EXTENSION

8166-1/2 UNIVERSAL JOINT

8150SL RATCHET 1/2, SLIM HEAD 72T

6700SM-4 SOCKET 1/4 4, 4.5, 5, 5.5, 6, 7, 8, 9, 10, 11, 12, 13 mm

6954 T-HANDLE

6960 EXTENSION 1/4

6962 EXTENSION 1/4

6966 UNIVERSAL JOINT

59S/31-1 PZ1, PZ2 (x3), PZ3; PH1, PH2 (x3), PH3; PH2G (x2); T10, T15 (x3), T20 (x3), T25 (x2), T27, T30. SL: 3, 4, 5, 5.5mm; HEX: 3mm, 4, 5, 6mm. 1/4" Magnetic bit holder.

6950SL RATCHET 1/4, SLIM HEAD 72T

3735-4-120 CENTRE PUNCH

3734 COTTER PIN PUNCH 2, 3, 4, 5, 6, 8 mm

BE-8257 SCREWDRIVER ERGO 1.6X8,0X175

BE-8255 SCREWDRIVER ERGO 1.2X6,5X150

BE-8242 SCREWDRIVER ERGO 1,0X5,5X150

BE-8040 SCREWDRIVER ERGO 0,8X4,0X100

BE-8030 SCREWDRIVER ERGO 0,6X3,5X75

BE-8611 SCREWDRIVER ERGO PH1X75

AUTO SMALL COMPOSITION

BE-8620 SCREWDRIVER ERGO PH2X100

BE-8910 SCREWDRIVER ERGO TX 10X75

BE-8915 SCREWDRIVER ERGO TX 15X100

BE-8920 SCREWDRIVER ERGO TX 20X100

BE-8925 SCREWDRIVER ERGO TX 25X125

BE-8927 SCREWDRIVER ERGO TX 27X125

BE-8930 SCREWDRIVER ERGO TX 30X150

BE-8940 SCREWDRIVER ERGO TX 40X150

BE-8577 SCREWDRIVER ERGO 1/4 BIT HOLDER

BE-8355 SCREWDRIVER ERGO 1,2X6,5X25

BE-8602 SCREWDRIVER ERGO PH2X25

2630D-180 COMBINATION PLIER 180 mm

2430 G-200 IP SNIPER NOSE CUTTING 200 mm

7224 SLIP JOINT PLIER 250 mm

2953-250 UNIVERSAL LOCKING CURVED PLIER 250 mm

2101G-160IP SIDE CUTTER 160 mm

479-16 BALL PEIN HAMMER

3625N-35 PLASTIC HAMMER

MTB-3-16 3M TAPE MEASURE 16MM

SC127 ELECTRICIAN'S SCISSORS 127MM

BE-9678 BLACK KEYS SETS FOR HEX SCREWS, LONG BALL END 1.5, 2, 2.5, 3, 4, 5, 6, 8, 10

BE-9575 BLACK KEYS SETS FOR TORX SCREWS, LONG BALL END T9, 10, 15, 20, 25, 27, 30, 40



GENERAL INDUTRY HD RIGID CASE COMPOSITION

■ 4750RCHDW02FF1

MRO composition in a HD Rigid Case

- MRO composition in a HD Rigid Case:
 - 1/4 and 1/2 socket drivers. Deep and standard
 - Combination wrenches
 - Slotted, PH and TORX screwdrivers
 - Bits covering all profiles
 - Pliers: Side Cutters, combination, snipe nose, slip joint pliers, etc
- Suitable for all MRO applications
- Hardware: 4750RCHDW02 HD Rigid Case with Wheels



MRO COMPOSITION

111M COMBINATION WRENCH 6, 7, 8, 9, 10, 11, 12, 13, 14, 15, 16, 17, 18, 19, 20, 21, 22, 23, 24, 25, 26, 27, 28, 29, 30, 32 mm

1150-1/2H/P CALIPER 150MM

1177-SCRIBE OFFSET SCRIBER 230 mm

1544 FEELER GAUCHE

1RM RATCHET COMBINATION WRENCH 6, 7, 8, 9, 10, 11, 12, 13, 14, 15, 16, 17, 18, 19 mm

2058-BR BIT-RATCHET 1/4IN

2101G-160IP SIDE CUTTER 160 mm

2427 G-200 IP SNIPE NOSE BENT 200 mm

2430 G-200 IP SNIPE NOSE CUTTING 200 mm

2509 FLEX. PICK UP

2535F1 MAGNETIC PICK UP1 KGR

2628 G-160IP COMBINATION PLIER 160 mm

2820EF2 ELEC-KNIFE PLASTIC HNDLE 200MM

3625W-35 NYLON TIP MALLET 35 MM.

3734 COTTER PIN PUNCH 3, 5, 8

3735-4-120 CENTER PUNCH

481-300 GERMAN DIN-HAMMER

5515T-52 TELESCOPE MIRROR

59/S31 PZ1, PZ2 (x3), PZ3; PH1, PH2 (x3), PH3; PH2G (x2); T10, T15 (x3), T20 (x3), T25 (x2), T27 and T30. SL: 3, 4, 5, 5.5mm; HEX: 3mm, 4, 5, 6mm. 1/4 " Magnetic bit holder.

6700SM SOCKET 1/4 6,7, 8, 9, 10, 11, 12, 13 mm

6709M SOCKET DRIVER 1/4 HEX 3, 4, 5, 6, 8 mm

6709PH SOCKET DRIVER 1/4 PH 1, 2, 3

6709TORX SOCKET DRIVER 1/4 TORX 8, 9, 10, 15, 20, 25, 27, 30, 40 mm

6950SL RATCHET 1/4, SLIM HEAD 72T

6954 T-HANDLE

6956 SPINNER HANDLE 1/4

6958 BREAKER BAR

6960 EXTENSION 1/4 50 mm

6962 EXTENSION 1/4 150 mm

6962L EXTENSION BAR 1/4 355 mm

6966 UNIVERSAL JOINT

6972H POWER SOCKET HOLDER 1/4

7764 ADAPTOR 3/8 TO 1/4

7800SM SOCKET 1/2 8, 9, 10, 11, 12, 13, 14, 15, 16, 17, 18, 19, 21, 22, 23, 24, 25, 26, 27, 28, 30, 32 mm

7805SM SOCKET DEEP 1/2 10, 12, 13, 14, 15, 16, 17, 18, 19, 20, 21, 22, 23, 24, 25, 26, 27, 28, 29, 30, 32 mm

7809TORX SOCKET 1/2 TORX 25, 27, 30, 40, 45, 50 mm

8150RN-1/2 RATCHET 1/2, ROUND TYPE

8154-1/2 T HANDLE

8158-1/2 BREAKER BAR

8159-1/2 EXTENSION 75 mm

8160-1/2 EXTENSION 125 mm

8162-1/2 EXTENSION 250 mm

8166-1/2 UNIVERSAL JOINT

8224 IP SLIP JOINT PLIER 8224 250 mm

9070C ADJUSTABLE WRENCH 9070 C 6"

A6800DM SOCKET 1/4 AEROSPACE 5.5, 6, 7, 8, 9, 10, 11, 12, 13

BE-8571 PH1, 2 PZ1, 2 and 5.5 and 6.5 slotted 100 mm blades with quick release SCD

BE-9770 BLACK KEYS SETS FOR HEX SCREWS, LONG BALL END 1.5, 2, 2.5, 3, 4, 5, 6, 8, 10 mm

BFLA01 Q3 LED TORCH

MTB-3-16 3M TAPE MEASURE 16 mm



GENERAL INDUSTRY AND VDE COMPOSITIONS

■ TO BE DEVELOPED UNDER REQUEST

GENERAL INDUSTRY COMPOSITION

- Two versions: general industry and VDE
- First drawer always standard composition
- Second drawer to be chosen between VDE or standard composition



DRAWER 1 STANDARD RANGE

9031 ADJUSTABLE WRENCH 9031

9072 ADJUSTABLE WRENCH 9072 10"

7800SM SOCKET 1/2 8, 9, 10, 11, 12, 13, 14, 15, 16, 17, 18, 19, 21, 22, 23, 24, 25, 27, 28, 30, 32 mm

8155-1/2 RATCHET 1/2, ERGO

8160-1/2 EXTENSION

8162-1/2 EXTENSION BAR 250 MM

8154-1/2 T-HANDLE

8166-1/2 UNIVERSAL JOINT

7809M-6 SOCKET DRIVER 1/2, HEX 6, 8, 9, 10, 12

111M COMBINATION WRENCH 6, 7, 8, 9, 10, 11, 12, 13, 14, 15, 16, 17, 18, 19, 22, 24, 27, 30, 32 mm

225-PLUS HACKSAW FRAMES

208 HACKSAW FRAMES

KERU-01 ERGO RETRACTABLE UTILITY KNIFE

MTS-5-25 5M TAPE 25MM STAINLESS

481-500 GERMAN DIN-HAMMER

DRAWER 2 VDE VERSION

2101S-160 SIDE CUTTER 160 mm

2628 S-180 COMBINATION PLIER 180 mm

2430 S-200 SNIPE NOSE CUTTER 200 mm

2427 S-200 LONG NOSE PLIER 200 mm

8224CIP SLIP JOINT PLIER 250 mm

BE-8220S SCREWDRIVER ERGO IEC 0,5X3,0X100

BE-8040S SCREWDRIVER ERGO IEC 0,8X4,0X100

BE-8050S SCREWDRIVER ERGO IEC 1,0X5,5X125

BE-8255S SCREWDRIVER ERGO IEC 1,2X6,5X150

BE-8065S SCREWDRIVER ERGO IEC 1,2X8,0X175

BE-8610S SCREWDRIVER ERGO IEC PH1X80

BE-8620S SCREWDRIVER ERGO IEC PH2X100

BE-8340 SCREWDRIVER ERGO 0,8X4X25

BE-8601 SCREWDRIVER ERGO PH1X25

8045LVDE VOLTAGE TESTER VDE 0,5X3,5X42

BE-9777 SCREW.DR SET HEX 2,5-10

DRAWER 2 MRO VERSION

2101GC-160IP SIDE CUTTER 160 mm

2628 GC-180IP COMBINATION PLIER 180 mm

2430 GC-200 IP SNIPE NOSE CUTTING CHROME 200 mm

2427 GC-200IP LONG,ROUND NOSE CHROMED PL 200 mm

8224CIP SLIP JOINT PLIER 250 mm

BE-8020 SCREWDRIVER ERGO 0,5X3,0X60

BE-8040 SCREWDRIVER ERGO 0,8X4,0X100

BE-8150 SCREWDRIVER ERGO 1,0X5,5X100

BE-8155 SCREWDRIVER ERGO 1,2X6,5X125

BE-8601 SCREWDRIVER ERGO PH1X25

BE-8602 SCREWDRIVER ERGO PH2X25

BE-8220 SCREWDRIVER ERGO 0,5X3,0X125

BE-8340 SCREWDRIVER ERGO 0,8X4X25

BE-8601 SCREWDRIVER ERGO PH1X25

8045LVDE VOLTAGE TESTER VDE 0,5X3,5X42

BE-9777 SCREW.DR SET HEX 2,5-10



GENERAL INDUSTRY MEDIUM

■ FF1A5002 + FF1A17 + FF1A03 MRO COMPOSITION FOR TROLLEYS



FF1A5002 - 27 pcs

- 111M-6 COMBINATION WRENCH
- 111M-7 COMBINATION WRENCH
- 111M-8 COMBINATION WRENCH
- 111M-9 COMBINATION WRENCH
- 111M-10 COMBINATION WRENCH
- 111M-11 COMBINATION WRENCH
- 111M-12 COMBINATION WRENCH
- 111M-13 COMBINATION WRENCH
- 111M-14 COMBINATION WRENCH
- 111M-15 COMBINATION WRENCH
- 111M-16 COMBINATION WRENCH
- 111M-17 COMBINATION WRENCH
- 111M-18 COMBINATION WRENCH
- 111M-19 COMBINATION WRENCH
- 111M-20 COMBINATION WRENCH
- 111M-21 COMBINATION WRENCH
- 111M-22 COMBINATION WRENCH
- 111M-24 COMBINATION WRENCH
- 111M-27 COMBINATION WRENCH
- 111M-30 COMBINATION WRENCH
- 111M-32 COMBINATION WRENCH
- 3734S/6 COMBINATION WRENCH



FF1A17 - 61 pcs

- BE-9780 BLACK HEX KEYS SET, LONG BALL END, 12 PCS
0.050", 1/16", 5/64", 3/32", 7/64", 1/8", 9/64", 5/32", 3/16", 7/32", 1/4", 5/16"
- BE-8020L / BE-8220 SLOTTED SCREWDRIVERS, ERGO™
0.5x3x75 mm, 0.5x3x125 mm
- BE-8150 / BE-8155 SLOTTED SCREWDRIVERS, ERGO™
1x5.5x100 mm, 1.2x6.5x125 mm
- BE-8260 SCREWDRIVER ERGO™
SLOTTED
1.6X8,0X175
- BE-8610 / BE-8620 / BE-8630 PHILLIPS SCREWDRIVERS, ERGO™
PH1X75 mm, PH2X100 mm, PH3X150 mm
- BE-8601 / BE-8602 PHILLIPS SCREWDRIVERS, ERGO™
PH1X25 mm, PH2X25 mm
- 2047-1-5.5 DOUBLE OFFSET KEY FOR SLOTTED SCREWS
1X5.5X125 mm
- 2047PR-1-2 DOUBLE OFFSET KEY FOR PHILLIPS SCREWS
PH1 & 2
- 706-2 PRECISION SCREWDRIVERS SET, FOR SLOTTED & PHILLIPS SCREWS
1.0X50, 1.2X50, 1.5X50, 1.8X50 mm, PH0, PH00
- 2058-BR BIT-RATCHET 1/4"
- 59/S28-4 BITS SET FOR SLOTTED, PHILLIPS, TORX®, HEXAGON AND TORQ-SET® HEAD SCREWS
28 PCS
- BE-8350 SCREWDRIVER ERGO™
SLOTTED, STUBBY
1X5.5X25
- 808050 RATCHETING BIT SCREWDRIVER



FF1A03 - 18 pcs

- BE-9770 BLACK HEX KEYS SET, LONG BALL END, 9 PCS
1.5, 2, 2.5, 3, 4, 5, 6, 8, 10
- 2171G-160 SIDE CUTTER 160 mm
- 2678G-160 COMBINATION PLIER 160 mm
- 2971G-250 SLIP JOINT PLIER 250 mm
- 3734N DRIFT PUNCH 4x150, 6x150
- 481-400 DIN-HAMMER
- 306 HACKSAW FRAME AND SANDFLEX® BI-METAL BLADE
- 1-100-08-2-2 8" FLAT FILE, WITH HANDLE, SECOND
- MTG-5-19 5m TAPE MEASURE 19mm



GENERAL INDUSTRY BIG

■ FF1A3004 + FF1A2501 + FF1A4001+ FF1A1007 + FF1A12

MRO COMPOSITION FOR TROLLEYS

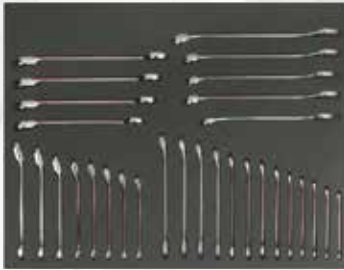

FF1A3004 - 30 pcs

- 111M-6 COMBINATION WRENCH
- 111M-7 COMBINATION WRENCH
- 111M-8 COMBINATION WRENCH
- 111M-9 COMBINATION WRENCH
- 111M-10 COMBINATION WRENCH
- 111M-11 COMBINATION WRENCH
- 111M-12 COMBINATION WRENCH
- 111M-13 COMBINATION WRENCH
- 111M-14 COMBINATION WRENCH
- 111M-15 COMBINATION WRENCH
- 111M-16 COMBINATION WRENCH
- 111M-17 COMBINATION WRENCH
- 111M-18 COMBINATION WRENCH
- 111M-19 COMBINATION WRENCH
- 111M-20 COMBINATION WRENCH
- 111M-21 COMBINATION WRENCH
- 111M-22 COMBINATION WRENCH
- 111M-24 COMBINATION WRENCH
- 1RM-8 RATCHET WRENCH
- 1RM-9 RATCHET WRENCH
- 1RM-10 RATCHET WRENCH
- 1RM-11 RATCHET WRENCH
- 1RM-12 RATCHET WRENCH
- 1RM-13 RATCHET WRENCH
- 1RM-14 RATCHET WRENCH
- 1RM-15 RATCHET WRENCH
- 1RM-16 RATCHET WRENCH
- 1RM-17 RATCHET WRENCH
- 1RM-18 RATCHET WRENCH
- 1RM-19 RATCHET WRENCH



FF1A4001 - 12 pcs

- 1520D POWER CUTTER 1520 D
- 2101G-160IP SIDE CUTTER 160 mm
- 21HDG-200IP ERGO SIDE CUTTERHD 200 mm
- 2223G-150 STRIPPING PLIERS ERGO 150 mm
- 2421G-140IP FLAT NOSE PL LONG 140 mm
- 2421G-180IP FLAT NOSE PL 180 mm
- 2427G-200IP SNIPE NOSE BENT G 200 mm
- 2628G-180IP COMB PLIER 180 mm
- 2681 RIVET GUN
- 2951-140 CURVED JAWS CLAMP 140 mm
- 2951-300 GRIP WITH WIRE CUTTER 300 mm
- 8224IP SLIP JOINT PLIER 250 mm



GENERAL INDUSTRY BIG

■ FF1A3004 + FF1A2501 + FF1A4001+ FF1A1007 + FF1A12

MRO COMPOSITION FOR TROLLEYS



FF1A1007 - 63 pcs

- 2510 WORKSHOP MIRROR
- 5468-112 TWEEZER 5468-112
- 5471F-145 TWEEZER 5471 F-145
- 59/S31 IMPACT BITS SET 31PCS
- BE-8040 SCREW.DR ERGO 0,8 X 4,0 X 100
- BE-8158 SCREW.DR ERGO 1,0 X 5,5 X 125
- BE-8159 SCREW.DR ERGO 1,2 X 6,5 X 150
- BE-8220 SCREW.DR ERGO 0,5 X 3,0 X 125
- BE-8340 SCREW.DR ERGO 0,8 X 4 X 25
- BE-8601 SCREW.DR ERGO PH1 X 25
- BE-8628 SCREW.DR ERGO PH1 X 100
- BE-8629 SCREW.DR ERGO PH2 X 125
- BE-8865 SCREW.DR ERGO 1,6 X 8,0 X 175
- BE-8906 SCREW.DR ERGO TX 6 X 50
- BE-8907 SCREW.DR ERGO TX 7 X 55
- BE-8908 SCREW.DR ERGO TX 8 X 60
- BE-8909 SCREW.DR ERGO TX 9 X 60
- BE-8910 SCREW.DR ERGO TX 10 X 65
- BE-8915 SCREW.DR ERGO TX 15 X 70
- BE-8920 SCREW.DR ERGO TX 20 X 80
- BE-8925 SCREW.DR ERGO TX 25 X 80
- BE-8930 SCREW.DR ERGO TX 30 X 100
- BE-9770 SCREW.DR SET HEX 1,5-10
- TL124-SA TWEEZER 124-SA



FF1A12 - 19 pcs

- 481-300 / 481-500 DIN HAMMER
300, 500 mm
- 3625W-35 NYLON TIP HAMMER
- 8158-1/2 BREAKER BAR 380 mm
- 2509 FLEXIBLE PICK-UP TOOL 525 mm
- 2535F2 MAGNETIC PICK-UP TOOL 1 kg
- 3734 DRIFT PUNCHES
Ø 3, 5, 8 mm
- 3735-4-120 CENTRE PUNCH
120 mm
- 3740-150 FLAT CHISEL
150 mm
- 3745-150 CAPE CHISEL
150 mm
- 1-100-06-1-2 6" FLAT FILE
WITH HANDLE, BASTARD
- 1-100-06-2-2 6" FLAT FILE,
WITH HANDLE, SECOND
- 1-160-06-1-2 6" SQUARE FILE,
WITH HANDLE, BASTARD
- 1-210-06-1-2 6" HALF ROUND FILE,
WITH HANDLE, BASTARD
- 1-230-06-1-2 6" ROUND FILE, WITH HANDLE, BASTARD
- FS-8 SCISSORS
7,5 cm BLADE
- 319 HACKSAW FRAME AND
BI-METAL SANDFLEX® BLADE



GENERAL INDUSTRY BIG

■ FF1A3004 + FF1A2501 + FF1A4001 + FF1A1007 + FF1A12

MRO COMPOSITION FOR TROLLEYS



FF1A2501 - 83 pcs

6700SM-4 SOCKET 1/4

6700SM-5 SOCKET 1/4

6700SM-5.5 SOCKET 1/4

6700SM-6 SOCKET 1/4

6700SM-7 SOCKET 1/4

6700SM-8 SOCKET 1/4

6700SM-9 SOCKET 1/4

6700SM-10 SOCKET 1/4

6700SM-11 SOCKET 1/4

6700SM-12 SOCKET 1/4

6700SM-13 SOCKET 1/4

6700TORX-E8 SOCKET 1/4

6700TORX-E10 SOCKET 1/4

6709M-3 SOCKET 1/4

6709M-4 SOCKET 1/4

6709M-5 SOCKET 1/4

6709M-6 SOCKET 1/4

6709M-8 SOCKET 1/4

6709TORX-T8 SOCKET 1/4

6709TORX-T10 SOCKET 1/4

6709TORX-T15 SOCKET 1/4

6709TORX-T20 SOCKET 1/4

6709TORX-T25 SOCKET 1/4

6709TORX-T27 SOCKET 1/4

6709TORX-T30 SOCKET 1/4

6709TORX-T40 SOCKET 1/4

6950SL RATCHET 1/4, SLIM HEAD 72T

6954 T-HANDLE 1/4

6956 NUT DRIVER 1/4

6962 EXTENSION 1/4

6966 UNIVERSAL JOINT 1/4

7400SM-8 SOCKET 3/8

7400SM-9 SOCKET 3/8

7400SM-10 SOCKET 3/8

7400SM-11 SOCKET 3/8

7400SM-12 SOCKET 3/8

7400SM-13 SOCKET 3/8

7400SM-14 SOCKET 3/8

7400SM-15 SOCKET 3/8

7400SM-16 SOCKET 3/8

7400SM-17 SOCKET 3/8

7400SM-18 SOCKET 3/8

7400SM-19 SOCKET 3/8

7400SM-20 SOCKET 3/8

7400SM-21 SOCKET 3/8

7400SM-22 SOCKET 3/8

7400TORX-E8 SOCKET 3/8

7400TORX-E10 SOCKET 3/8

7400TORX-E12 SOCKET 3/8

7400TORX-E14 SOCKET 3/8

7750SL RATCHET 3/8, SLIM HEAD 72T

7754 T-HANDLE 3/8

7762 EXTENSION 3/8

7764 ADAPTOR 3/8

7765 ADAPTOR 3/8

7766 UNIVERSAL JOINT

7768 SMOOTH OPERATION U.JOINT- 3/8

7800SM-12 SOCKET 1/2

7800SM-13 SOCKET 1/2

7800SM-17 SOCKET 1/2

7800SM-18 SOCKET 1/2

7800SM-19 SOCKET 1/2

7800SM-20 SOCKET 1/2

7800SM-21 SOCKET 1/2

7800SM-22 SOCKET 1/2

7800SM-24 SOCKET 1/2

7800SM-27 SOCKET 1/2

7800SM-30 SOCKET 1/2

7800SM-32 SOCKET 1/2

7809M-10 SOCKET 1/2

7809M-12 SOCKET 1/2

7809TORX-T20 SOCKET 1/2

7809TORX-T25 SOCKET 1/2

7809TORX-T40 SOCKET 1/2

7809TORX-T50 SOCKET 1/2

7809TORX-T55 SOCKET 1/2

8150SL RATCHET 1/2, SLIM HEAD 72T

8154-1/2 T-HANDLE 1/2

8162-1/2 EXTENSION 1/2

8164-1/2 ADAPTOR 1/2

8165-1/2 ADAPTOR 1/2

8166-1/2 UNIVERSAL JOINT 1/2

8964 ADAPTOR 1/2



GENERAL INDUSTRY INCHES

■ FF1A14 + FF1A13 + FF1A4001 + FF1A1007 + FF1A12 MRO COMPOSITION FOR TROLLEYS



FF1A13 - 82 pcs

A6800DZ SOCKETS 1/4" BI-HEX, AEROSPACE LONG SERIES
3/16", 7/32", 1/4", 9/32", 5/16", 11/32", 3/8", 7/16", 1/2",
9/16"

A6800DM SOCKETS 1/4", AEROSPACE LONG SERIES
4", 10"

6700SZ-5/32 SOCKET 1/4", SHORT SERIES

A6700DZ SOCKETS 1/4", BI-HEX, AEROSPACE SHORT SERIES
3/16", 7/32", 1/4", 9/32", 5/16", 11/32", 3/8", 7/16", 1/2",
9/16"

A6710DZ SWIVEL SOCKETS 1/4", BI-HEX, AEROSPACE
3/16", 7/32", 1/4", 9/32", 5/16", 11/32", 3/8", 7/16", 1/2",
9/16"

6966 UNIVERSAL JOINT 1/4"

6950SL REVERSIBLE RATCHET 1/4", SLIMHEAD

6958 BREAKER BAR 1/4"

6954 T-HANDLE 1/4"

6956 SPINNER HANDLE 1/4"

6960 / 6961 / 6962 / 6962L EXTENSION BARS 1/4"
50, 100, 150, 355 mm

A7400DZ SOCKET 3/8" BI-HEX, AEROSPACE SHORT SERIES
1/4", 5/16", 3/8", 7/16", 1/2", 17/32", 9/16", 19/32", 5/8",
11/16", 3/4", 13/16", 7/8"

A7402DZ SOCKETS 3/8", BI-HEX, LONG SERIES, AEROSPACE
1/4", 5/16", 3/8", 7/16", 1/2", 9/16", 5/8", 19/32", 11/16",
3/4", 13/16", 7/8"

7766 UNIVERSAL JOINT 3/8"

7750SL RATCHET 3/8", SLIMHEAD

7758 BREAKER BAR 3/8"

7754 T-HANDLE 3/8"

7752 SPEEDER 3/8"

7760 / 7761 / 7762 EXTENSION BARS 3/8"
75, 125, 250 mm

7764 ADAPTOR F 3/8" - M 1/4"

7765 ADAPTOR F 1/4" - M 3/8"

8165-1/2 ADAPTOR F 1/2" - M 3/8"

8164-1/2 ADAPTOR F 3/8" - M 1/2"

6972H BIT HOLDER 1/4"

7407H BIT HOLDER 3/8" 1/4" - 3/8"

7408H BIT HOLDER 3/8" - 5/16" - 3/8"

S6106KA SOCKET SPARK PLUG 7/8"



FF1A14 - 43 pcs

111Z COMBINATION WRENCHES
1/4", 5/16", 3/8", 7/16", 1/2", 9/16", 5/8", 11/16", 3/4",
13/16", 7/8", 15/16", 1"

1952Z-11/32 COMBINATION WRENCH
11/32"

1320RZ RATCHETING RING WRENCHES
1/4X5/16", 5/16X11/32", 3/8X7/16", 1/2X9/16"

1950MZ-3/8 CROWFOOT ADJUSTABLE WRENCH 3/8"

8069 C IP ADJUSTABLE CHROMED WRENCH 4" 110X13 mm

9070C ADJUSTABLE WRENCH CHROMED 6" ERGO™
158x20 mm

1931Z LILIPUT DOUBLE OPEN-END WRENCHES
5/32", 3/16", 7/32", 1/4", 9/32", 5/16", 11/32", 3/8", 7/16",
1/2", 9/16"

6Z DOUBLE OPEN-END WRENCHES
1/4X5/16", 5/16X11/32", 3/8X7/16, 1/2X9/16",
19/32X11/16", 5/8X3/4", 25/32X13/16", 7/8X15/16",
15/16X1", 1X1.1/8", 1.1/16X1.1/4"



FF1A4001 - 12 pcs

1520D POWER CUTTER 1520 D

2101G-160IP SIDE CUTTER 160 mm

21HDG-200IP ERGO SIDE CUTTERHD 200 mm

2223G-150 STRIPPING PLIERS ERGO 150 mm

2421G-140IP FLAT NOSE PL LONG 140 mm

2421G-180IP FLAT NOSE PL 180 mm

2427G-200IP SNIPE NOSE BENT G 200 mm

2628G-180IP COMB PLIER 180 mm

2681 RIVET GUN

2951-140 CURVED JAWS CLAMP 140 mm

2951-300 GRIP WITH WIRE CUTTER 300 mm

8224IP SLIP JOINT PLIER 250 mm



GENERAL INDUSTRY INCHES

■ FF1A14 + FF1A13 + FF1A4001 + FF1A1007 + FF1A12

MRO COMPOSITION FOR TROLLEYS



FF1A1007 - 63 pcs

- 2510 WORKSHOP MIRROR
- 5468-112 TWEEZER 5468-112
- 5471F-145 TWEEZER 5471 F-145
- 59/S31 IMPACT BITS SET 31PCS
- BE-8040 SCREW.DR ERGO 0,8 X 4,0 X 100
- BE-8158 SCREW.DR ERGO 1,0 X 5,5 X 125
- BE-8159 SCREW.DR ERGO 1,2 X 6,5 X 150
- BE-8220 SCREW.DR ERGO 0,5 X 3,0 X 125
- BE-8340 SCREW.DR ERGO 0,8 X 4 X 25
- BE-8601 SCREW.DR ERGO PH1 X 25
- BE-8628 SCREW.DR ERGO PH1 X 100
- BE-8629 SCREW.DR ERGO PH2 X 125
- BE-8865 SCREW.DR ERGO 1,6 X 8,0 X 175
- BE-8906 SCREW.DR ERGO TX 6 X 50
- BE-8907 SCREW.DR ERGO TX 7 X 55
- BE-8908 SCREW.DR ERGO TX 8 X 60
- BE-8909 SCREW.DR ERGO TX 9 X 60
- BE-8910 SCREW.DR ERGO TX 10 X 65
- BE-8915 SCREW.DR ERGO TX 15 X 70
- BE-8920 SCREW.DR ERGO TX 20 X 80
- BE-8925 SCREW.DR ERGO TX 25 X 80
- BE-8930 SCREW.DR ERGO TX 30 X 100
- BE-9770 SCREW.DR SET HEX 1,5-10
- TL124-SA TWEEZER 124-SA



FF1A12 - 19 pcs

- 481-300 / 481-500 DIN HAMMER
300, 500 mm
- 3625W-35 NYLON TIP HAMMER
- 8158-1/2 BREAKER BAR 380 mm
- 2509 FLEXIBLE PICK-UP TOOL 525 mm
- 2535F2 MAGNETIC PICK-UP TOOL 1 kg
- 3734 DRIFT PUNCHES
Ø 3, 5, 8 mm
- 3735-4-120 CENTRE PUNCH
120 mm
- 3740-150 FLAT CHISEL
150 mm
- 3745-150 CAPE CHISEL
150 mm
- 1-100-06-1-2 6" FLAT FILE
WITH HANDLE, BASTARD
- 1-100-06-2-2 6" FLAT FILE,
WITH HANDLE, SECOND
- 1-160-06-1-2 6" SQUARE FILE,
WITH HANDLE, BASTARD
- 1-210-06-1-2 6" HALF ROUND FILE,
WITH HANDLE, BASTARD
- 1-230-06-1-2 6" ROUND FILE, WITH HANDLE, BASTARD
- FS-8 SCISSORS
7,5 cm BLADE
- 319 HACKSAW FRAME AND
BI-METAL SANDFLEX® BLADE



GENERAL INDUSTRY VDE

■ FF1A3004 + FF1A5009 + FF1A03 MRO COMPOSITION FOR TROLLEYS



FF1A3004 - 30 pcs

- 111M-6 COMBINATION WRENCH
- 111M-7 COMBINATION WRENCH
- 111M-8 COMBINATION WRENCH
- 111M-9 COMBINATION WRENCH
- 111M-10 COMBINATION WRENCH
- 111M-11 COMBINATION WRENCH
- 111M-12 COMBINATION WRENCH
- 111M-13 COMBINATION WRENCH
- 111M-14 COMBINATION WRENCH
- 111M-15 COMBINATION WRENCH
- 111M-16 COMBINATION WRENCH
- 111M-17 COMBINATION WRENCH
- 111M-18 COMBINATION WRENCH
- 111M-19 COMBINATION WRENCH
- 111M-20 COMBINATION WRENCH
- 111M-21 COMBINATION WRENCH
- 111M-22 COMBINATION WRENCH
- 111M-24 COMBINATION WRENCH
- 1RM-8 RATCHET WRENCH
- 1RM-9 RATCHET WRENCH
- 1RM-10 RATCHET WRENCH
- 1RM-11 RATCHET WRENCH
- 1RM-12 RATCHET WRENCH
- 1RM-13 RATCHET WRENCH
- 1RM-14 RATCHET WRENCH
- 1RM-15 RATCHET WRENCH
- 1RM-16 RATCHET WRENCH
- 1RM-17 RATCHET WRENCH
- 1RM-18 RATCHET WRENCH
- 1RM-19 RATCHET WRENCH



FF1A5009 - 17 pcs

- 2101S-160 SIDE CUTTER 160 mm
- 2223S-150 STRIPPING PLIER 150 mm
- 2250V-170 CABLE CUTTER 1000V 8D
- 2430S-200 LONG NOSE PLIER 200 mm
- 2628S-180 COMB PLIER 180 mm
- 8072V ADJUSTABLE WRENCH 1000V 10"
- BE-8220S SCREW.DR ERGO IEC 0,5 X 3,0 X 100
- BE-8040S SCREW.DR ERGO IEC 0,8 X 4,0 X 100
- BE-8340 SCREW.DR ERGO 0,8 X 4 X 25
- BE-8050S SCREW.DR ERGO IEC 1,0 X 5,5 X 125
- BE-8255S SCREW.DR ERGO IEC 1,2 X 6,5 X 150
- BE-8065S SCREW.DR ERGO IEC 1,2 X 8,0 X 175
- BE-8601 SCREW.DR ERGO PH1 X 25
- BE-8610S SCREW.DR ERGO IEC PH1 X 75
- BE-8620S SCREW.DR ERGO IEC PH2 X 100
- BE-8810S SCREW.DR ERGO IEC PZ1 X 75
- BE-8820S SCREW.DR ERGO IEC PZ2 X 100



FF1A03 - 18 pcs

- BE-9770 BLACK HEX KEYS SET, LONG BALL END, 9 PCS
1.5, 2, 2.5, 3, 4, 5, 6, 8, 10
- 2171G-160 SIDE CUTTER 160 mm
- 2678G-160 COMBINATION PLIER 160 mm
- 2971G-250 SLIP JOINT PLIER 250 mm
- 3734N DRIFT PUNCH 4x150, 6x150
- 481-400 DIN-HAMMER
- 306 HACKSAW FRAME AND SANDFLEX® BI-METAL BLADE
- 1-100-08-2-2 8" FLAT FILE, WITH HANDLE, SECOND
- MTG-5-19 5m TAPE MEASURE 19mm





WINDPOWER COMPOSITIONS

■ 4750RCHDW02FF2

Windpower General Purpose Composition

- Windpower compositions developed together with Danish Windpower Academy. It has been specifically developed for repair and maintenance of Siemenes and Vestas Windmills
- Includes two boxes. Standard box with daily hand tools like wrenches, sockets 1/2, pliers, screwdrivers and lanyards. A Heavy Duty Box with special tools to be used in certain applications
- Hardware: 4750RCHDW02



ERGO TOOL MANAGEMENT SYSTEM



STANDARD BOX

4750RCHDW02 HD Rigid Case

Inlay 01 FOAM W/ SOCKETS 3/8-1/4

6700SM-5.5 SOCKET 1/4

6700SM-6 SOCKET 1/4

6700SM-7 SOCKET 1/4

6700SM-8 SOCKET 1/4

6700SM-9 SOCKET 1/4

6700SM-10 SOCKET 1/4

6700SM-11 SOCKET 1/4

6700SM-12 SOCKET 1/4

6700SM-13 SOCKET 1/4

6954 T-HANDLE

6956 SPINNER HANDLE 1/4

6958 BREAKER BAR

6960 EXTENSION 1/4 50MM

6961 EXTENSION 1/4

6962 EXTENSION 1/4 150MM

6962L EXTENSION BAR 1/4IN 355 MM

6966 UNIVERSAL JOINT

6972H POWER SOCKET HOLDER 1/4

6950SL RATCHET 1/4, SLIM HEAD 72T

8158-1/2 BREAKER BAR

7800SM-10 SOCKET 1/2

7800SM-11 SOCKET 1/2

7800SM-12 SOCKET 1/2

7800SM-13 SOCKET 1/2

7800SM-14 SOCKET 1/2

7800SM-15 SOCKET 1/2

7800SM-16 SOCKET 1/2

7800SM-17 SOCKET 1/2



7800SM-18 SOCKET 1/2

7800SM-19 SOCKET 1/2

7800SM-21 SOCKET 1/2

7800SM-22 SOCKET 1/2

7800SM-24 SOCKET 1/2

7800SM-27 SOCKET 1/2

7800SM-30 SOCKET 1/2

7800SM-32 SOCKET 1/2

7809M-5 SOCKET DRIVER 1/2, HEX 5

7809M-6 SOCKET DRIVER 1/2, HEX 6

7809M-7 SOCKET DRIVER 1/2, HEX 7

7809M-8 SOCKET DRIVER 1/2, HEX 8

7809M-10 SOCKET DRIVER 1/2, HEX 10

7809M-12 SOCKET DRIVER 1/2, HEX 12

7809M-14 SOCKET DRIVER 1/2, HEX 14

7809M-17 SOCKET DRIVER 1/2IN HEX.

7809M-19 SOCKET DRIVER 1/2IN HEX.

7809TORX-T40 SOCKET 1/2

7809TORX-T45 SOCKET 1/2

7809TORX-T50 SOCKET 1/2

7809TORX-T55 SOCKET 1/2

7809TORX-T60 SOCKET 1/2

8150SL RATCHET 1/2, SLIM HEAD 72T

8154-1/2 T HANDLE 1/2

8160-1/2 EXTENSION 1/2

8162-1/2 EXTENSION 1/2

8165-1/2 ADAPTOR 1/2

8166-1/2 UNIVERSAL JOINT 1/2

Inlay 02 FOAM W/ WRENCHES

111M-6 OPEN END WRENCH

111M-7 OPEN END WRENCH



111M-8 OPEN END WRENCH

111M-9 OPEN END WRENCH

111M-10 COMBINATION WRENCH

111M-11 COMBINATION WRENCH

111M-12 COMBINATION WRENCH

111M-13 COMBINATION WRENCH

111M-14 COMBINATION WRENCH

111M-15 COMBINATION WRENCH

111M-16 COMBINATION WRENCH

111M-17 COMBINATION WRENCH

111M-18 COMBINATION WRENCH

111M-19 COMBINATION WRENCH

111M-21 COMBINATION WRENCH

111M-22 COMBINATION WRENCH

111M-24 COMBINATION WRENCH

111M-27 COMBINATION WRENCH

111M-30 COMBINATION WRENCH

111M-32 COMBINATION WRENCH

Inlay 03 FOAM W/ WRENCHES

BE-9770 SCREW.DR.SET HEX 1,5-10

1177-SCRIBE OPEN END WRENCH

6M-6-7 COMBINATION WRENCH

6M-8-9 COMBINATION WRENCH

6M-10-11 OPEN END WRENCH

6M-12-13 OPEN END WRENCH

6M-14-15 OPEN END WRENCH

6M-16-17 ADJUSTABLE WRENCH 9070 6"

6M-18-19 ADJUSTABLE WRENCH 9072

6M-20-22 OFFSET SCRIBER 230 MM

6M-24-27 COMBINATION WRENCH

6M-30-32 COMBINATION WRENCH



WINDPOWER COMPOSITIONS

■ 4750RCHDW02FF2

Windpower General Purpose Composition

- Windpower compositions developed together with Danish Windpower Academy. It has been specifically developed for repair and maintenance of Siemenes and Vestas Windmills
- Includes two boxes. Standard box with daily hand tools like wrenches, sockets 1/2, pliers, screwdrivers and lanyards. A Heavy Duty Box with special tools to be used in certain applications
- Hardware: 4750RCHDW02



ERGO TOOL MANAGEMENT SYSTEM



STANDARD BOX

MTB-3-16-E 3M TAPE MEASURE 16MM ENGLISH

9070 OPEN END WRENCH

9072 OPEN END WRENCH

Inlay 04 FOAM W/ SCREWDRIVERS

BE-8020L SCREW.DR ERGO 0,5X3X7BE-8040

BE-8030 SCREW.DR ERGO 0,6X3,5X75

BE-8155 SCREW.DR ERGO 1,2X6,5X125

BE-8260 SCREW.DR ERGO 1,6X8,0X175

BE-8610 SCREW.DR ERGO PH1X75

BE-8620 SCREW.DR ERGO PH2X100

BE-8630 SCREW.DR ERGO PH3X150

BE-8810 SCREW.DR ERGO PZ1X150

BE-8820 SCREW.DR ERGO PZ2X150

BE-8830 SCREW.DR ERGO PZ3X150

1544 FEELER GAUCHE

2047-0.8-4 SCREWDR OFFSET 2047 0,8X4X100



2047PR-1-2 SCREWDR OFFSET 2047 PH 1-2

2058-BR BIT-RATCHET 1/4IN

2509 FLEX. PICK UP

59S/31-1 BITS SET 31PCS PH,PZ,T,HEX,SL

808050P PISTOL HANDLE RATCHETING SCREW

808050S STUBBY RATCHETING SCREWDR.

BE-8220S SCREWDRIVER INSULATED

BE-8040S SCREWDRIVER INSULATED

BE-8050S SCREWDRIVER INSULATED

BE-8610S SCREWDRIVER INSULATED

BE-8620S SCREWDRIVER INSULATED

2535F2 MAGNETIC PICK UP1 KGR SMALL

Inlay 05 FOAM W/ PLIERS

1150-1/2H/P CALIPER 150MM

2101G-160IP SIDE CUTTER 2101GC-160

2427 G-200 IP LONG,ROUND NOSE CHROMED PL 200

2430 G-200 IP SNIPE NOSE CUTTING CHROME 200

2628 G-160IP COMB PLIER CHROMED 160IP

2820EF2 ELEC-KNIFE PLASTIC HNDLE 200MM

5515T-52 TELESCOPE MIRROR

8224 IP SLIP JOINT PLIER8224CIP W/OCA

BFLA01 Q3 LED-TORCH

3625W-35 NYLON TIP MALLET 35 MM.

3734-3 COTTER PIN PUNCH

3734-5 COTTER PIN PUNCH

3734-8 COTTER PIN PUNCH

3735-4-120 CENTRE PUNCH

481-300 GERMAN DIN-HAMMER

3680 PRY BAR

Inlay 6 SPECIAL COMPARTMENT

3875-RL1 Retractable Lanyard X 4 UNITS

3875-WL1 Wrist Lanyard

4750-3PB-2 3 Pocket Belt

2535L Magnetic Extendable pick up tool



WINDPOWER COMPOSITIONS

■ 4750RCHDW02FF3

Windpower General Purpose Composition

- Windpower compositions developed together with Danish Windpower Academy. It has been specifically developed for repair and maintenance of Siemenes and Vestas Windmills
- Includes two boxes. Standard box with daily hand tools like wrenches, sockets 1/2, pliers, screwdrivers and lanyards. A Heavy Duty Box with special tools to be used in certain applications
- Hardware: 4750RCHDW02



ERGO TOOL MANAGEMENT SYSTEM



HEAVY DUTY BOX

4750RCHDW02 HD Rigid Case BIG

BE64520CH Oil Filter Tool

3625PU-50 Dead Hammer

489-1100 Hammer

1-473-08-2-2 File set

7444SG-M-36 Flogging Spanner

7444SG-M-41 Flogging Spanner

7444SG-M-46 Flogging Spanner

7444SG-M-50 Flogging Spanner

7444SG-M-55 Flogging Spanner

7452-100 Torque wrench 10-100

7455-340 Torque wrench 70-340

7452-1 Head for torque Wrench

7852-1 Head for torque Wrench

7452-7-13 OPEN END WRENCH

7452-7-17 OPEN END WRENCH

7452-7-19 OPEN END WRENCH

7452-8-13 OPEN END WRENCH

7452-8-17 OPEN END WRENCH

7452-8-19 OPEN END WRENCH

7852-8-24 Ring Wrench

7852-8-30 Ring Wrench

7764 3/8 - 1/4 Converter piece

8164-1/2 3/8 - 1/2 Converter piece

1952M-36 COMBINATION WRENCH

1952M-46 COMBINATION WRENCH

8900SM-27 3/4 SOCKET

8900SM-30 3/4 SOCKET

8900SM-32 3/4 SOCKET

8900SM-36 3/4 SOCKET

8900SM-38 3/4 SOCKET

8900SM-41 3/4 SOCKET

8900SM-46 3/4 SOCKET

8900SM-50 3/4 SOCKET

8952N 3/4 SOCKET ACCESSORIES

8961 3/4 SOCKET ACCESSORIES

1952M-50 COMBINATION WRENCH





■ **4750FB5ATS001 / 4750FB5BFF1 /
4750FB3-12TS100**



ERGO TOOL MANAGEMENT SYSTEM



4750FB5ATS001

4750FB5A TOOL CASE

2058/S2626 PIECE BIT SET

808050 RATCHETING SCREWDRIVER

80708" ADJUSTABLE WRENCH

2101G-160 160 MM SIDE CUTTER

2628G-180 180 MM COMBINATION PLIER



4750FB5BFF1

4750FB5B TOOL CASE

808050P-59/S31 PISTOL RATCHETING SCREWDRIVER

WITH 31 PIECE BIT SET

90708" ADJUSTABLE WRENCH

MTB-5-255M TAPE 25MM MAGNETIC

2101G-160 160 MM SIDE CUTTER

2628G-180 180MM COMBINATION PLIER

BE-9578 HEXAGON KEY SET



4750FB3-12TS100 Electrician Tool Kit

4750FB3-12 12" ELECTRICIAN BAG-HARD BOTTOM

2101G-180 SIDE CUTTER 2101G-180

2628G-200 COMB PLIER 200MM

2233D-160 STRIPPING/CUTTING PLIERS

268 MINI HACKSAW FRAMES

2444 MULTI PURPOSE KNIFE

BE-8510 SSCREW.DR ERGO IEC COMBI PH1X80

BE-8520S SCREW.DR ERGO IEC COMBI PH2X100

BE-8710S SCREW.DR ERGO IEC COMBI PZ1X80

BE-8720S SCREW.DR ERGO IEC COMBI PZ2X100

806-1-1 MAINS TESTER 3X65150-250V

CR B 01 TERMINAL PLIER YELLOW 220 MM

MTB-5-25 5M TAPE 25MM MAGNETIC



■ 4750FB4-18TS001 / 4750FB2W-TS00 / 4750FB2-19TS001



ERGO TOOL MANAGEMENT SYSTEM



4750FB4-18TS001 Service Engineers Tool Kit

4750FB4-18 LAPTOP&TOOLS BAG-HARD BOTTOM

2101G-160 SIDE CUTTER 2101G-160IP

2628G-180 COMBINATION PLIER

2430 G-160 SNIPE NOSE CUTTING 160

1RM/SH8 RATCHET COMBINATION WRENCH SET

7223SLIP JOINT PLIER

2233D-200 CABLE CUTTER

SL251/4" DRIVE SOCKET SET

90706" ADJUSTABLE WRENCH

9031 ADJUSTABLE WRENCH

483-20 JOINER HAMMER

BE-8020 SCREW.DR ERGO 0,5X3,0X60

BE-8040 SCREW.DR ERGO 0,8X4,0X100

BE-8150 SCREW.DR ERGO 1,0X5,5X100

BE-8155 SCREW.DR ERGO 1,2X6,5X125

BE-8610 SCREW.DR ERGO PH1X75

BE-8620 SCREW.DR ERGO PH2X100

SC127 ELECTRICIAN'S SCISSORS 127MM

SQZ150003 SQUEEZE KNIFE

BE-9777 SCREW.DR SET HEX 2,5-10

MTB-5-25 5M TAPE 25MM MAGNETIC

4750FB2W-TS001 Service Engineers Tool Kit

4750FB2W-24A RIGID CASE ON WHEELS-POUCHES

S240 SOCKET SET 1/2"

SL25 SOCKET SET 1/4"

BE-8030 SCREW.DR ERGO 0,6X3,5X75

BE-8242 SCREW.DR ERGO 1,0X5,5X150

BE-8155 SCREW.DR ERGO 1,2X6,5X125

BE-8600 SCREW.DR ERGO PH0X60

BE-8610 SCREW.DR ERGO PH1X75

BE-8620 SCREW.DR ERGO PH2X100

BE-8800 SCREW.DR ERGO PZ0X60

BE-8810 SCREW.DR ERGO PZ1X75

BE-8820 SCREW.DR ERGO PZ2X100

BE-8040S SCREW.DR ERGO IEC 0,8X4,0X100

2628G-180 COMB PLIER 2628G-180

2101G-180 SIDE CUTTER 2101G-180

7224 SLIP JOINT PLIER 7224

1520 G POWER CUTTER 1520 G

MTB-5-25 5M TAPE 25MM MAGNETIC

MA421 AVIAT.SNIP STRAL.CUT 250 MM

268 MINI HACKSAW FRAMES

32512" ERGO HACKSAW FRAME

479-16 BALL PEIN HAMMER

KERU-01 ERGO RETRACTABLE UTILITY KNIFE

BFLA01 Q3 LED TORCH W/ FOCUS

5515T TELESCOPIC MIRROR

9071 ADJUSTABLE WRENCH 9071 8"

4750FB2-19TS001 Service Maintenance Tool Kit

4750FB2-19A 19" CLOSED BAG-HARD BOTTOM

BE-8010S SCREW.DR ERGO IEC 0,4X2,5X75

BE-8040S SCREW.DR ERGO IEC 0,8X4,0X100

BE-8050S SCREW.DR ERGO IEC 1,0X5,5X125

BE-8220S SCREW.DR ERGO IEC 0,5X3,0X100

BE-8610S SCREW.DR ERGO IEC PH1X80

BE-8620S SCREW.DR ERGO IEC PH2X100

BE-8630S SCREW.DR ERGO IEC PH3X150

BE-8800S SCREW.DR ERGO IEC PZ0X60

BE-8820S SCREW.DR ERGO IEC PZ2X100

BE-8830S SCREW.DR ERGO IEC PZ3X150

706-4 PRECISION SCREDDRIVER SET

PC-12-V ENVENEER SAW PROCUT

1-210-08-2-28" 1/2 ROUND, WITH HANDLE, CUT 2

2101G-180 SIDE CUTTER 2101G-180v

2233 D-200 CUTTING/STRIPPING PLIERS

2628G-180 COMB PLIER 2628 G-180

268 MINI HACKSAW FRAME

3830-20-VIP HOLESAWS SANDFLEX

3830-25-VIP HOLESAWS SANDFLEX

3834-ARBR-730 ARBOR

4130 DIAGONAL CUTTER 4130

424P-16 CHISEL 424P-16 MM

424P-20 CHISEL 424P-20 MM

424P-25 CHISEL 424P-25 MM

428-16 CLAW HAMMER FIBREGLASS-SHAFT

484-1250 CLUB HAMMER

806-1-1 MAINS TESTER 3X65150-250V

8231 SLIP JOINT PLIER 225MM

9031 ADJUSTABLE WRENCH 9031

SL251/4" DRIVE SOCKET SET



1470K SERIES

26 INCHES TROLLEYS

- Suitable for Modular System
- Available in Orange, red, blue and black
- From 5 drawers to 8 drawers in any color
- Can be developed in any RAL color



Round key locking system. Strong keys and locking mechanism.



Click/detent closing system at the end of slides. This prevents the drawers from opening when moving.



Double wall frame. Drawers and slides work even if the frame gets damaged.

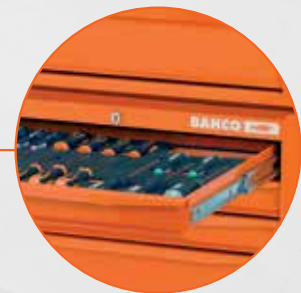

Drawer dimensions: Hx543x445 mm. Storage capacity: 0.157m3



Heavy duty construction with strong reinforcement in key areas. Total static load capacity: 600 kg



Long ball bearing slides. 100% opening drawers. Load capacity per drawer: 30 kg



Wheels 30x125 mm, ball bearings, 2 fixed and 2 swivel with brake. Good stability, easy to move and secure. Non marking rubber.

1470K7COLORS



1470K SERIES

26 INCHES TROLLEYS

- Suitable for Modular System.
- Available in Orange, red, blue and black
- From 5 drawers to 8 drawers in any color
- Can be developed in any RAL color

RANGE OF 26" TROLLEYS

CODE	DESCRIPTION
1470K5	5 DR TROLLEY-ORANGE RAL2009
1470K6	6 DR TROLLEY-ORANGE RAL2009
1470K7	7 DR TROLLEY-ORANGE RAL2009
1470K8	8 DR TROLLEY-ORANGE RAL2009
1470K5BLACK	5 DR TROLLEY-BLACK RAL9005
1470K6BLACK	6 DR TROLLEY-BLACK RAL9005
1470K7BLACK	7 DR TROLLEY-BLACK RAL9005
1470K8BLACK	8 DR TROLLEY-BLACK RAL9005
1470K5RED	5 DR TROLLEY-RED RAL3001
1470K6RED	6 DR TROLLEY-RED RAL3001
1470K7RED	7 DR TROLLEY-RED RAL3001
1470K8RED	8 DR TROLLEY-RED RAL3001
1470K5BLUE	5 DR TROLLEY-BLUE RAL5002
1470K6BLUE	6 DR TROLLEY-BLUE RAL5002
1470K7BLUE	7 DR TROLLEY-BLUE RAL5002
1470K8BLUE	8 DR TROLLEY-BLUE RAL5002
1480K4	4 DRAWERS TOP CHEST- ORANGE
1470K6YELLOW	6 DR TROLLEY-YELLOW RAL1023
1470KXL6C	XL W/CABINET 6DR ORANGE
1470KXL6CBLACK	XL W/CABINET 6DR BLACK

ACCESSORIES

CODE	DESCRIPTION
1470K-ACTD	26" MDF TOP
1470K-ACTW	26" WOODEN TOP
1470K-ACTSS	26" STAINLESS STEEL TOP
1470KXL-ACTD	40" MDF TOP
1470KXL-ACTW	40" WOODEN TOP
1470KXL-ACTSS	40" STAINLESS STEEL TOP
1470K-AC7	26" TOP W/CAVITIES ON LEFT
1470K-AC1	FOLDABLE TRAY X 1470 & 1475
1470K-AC2	PRY BAR/SD BOX x 1470K & 1475K
1470K-AC3	CAN HOLDER X 1470K & 1475K
1470K-AC4	DOC HOLDER X 1470K & 1475K
1470K-ACSIDE	SLOTS & DOTS SIDE PANEL
1470KAC01	DRAWER LINERS SET-7 UNITS
1470K-AC7	26" TOP W/CAVITIES ON LEFT

SPARE PARTS

CODE	DESCRIPTION
1470K-01	SLIDES (X2) 30KG CAPACITY
1470K-02	SWIWEL WHEELS (X2) 125X30MM
1470K-03	FIXED WHEELS (X2) 125X30MM
1470K-04001	LOCK & 2 KEYS OF 001 LOCK COMBINATION
1470K-04002	LOCK & 2 KEYS OF 002 LOCK COMBINATION
...	...
1470K-04200	LOCK & 2 KEYS OF 200 LOCK COMBINATION
1470K-05	HANDLE X 1470/75K SERIES
1470K-06	TOP MAT X 26" TROLLEYS

1475K SERIES

40 INCHES TROLLEYS

- Suitable for Modular System.
- Available in multiple colors: Orange, red, blue (dark and soft), green, purple and black
- From 5 drawers to 8 drawers in any color
- Can be developed in any RAL color



Drawers
Ball bearing slides.
Full opening drawers.
A load capacity of 45 kg per drawer.



WOODEN TOP

SNAWT1470 (26" trolleys)
SSNAWT1475 (40" trolleys)



RUBBER TOP



STAINLESS STEEL TOP

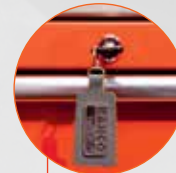

LOCKING SYSTEM

Central Locking System with tubular keys.
More than 210 keys available.



LOCK & GO!

The Lock & Go system secures the drawers automatically when closed.



Aluminium Brushed Handles
Easy to clean, lightweight handles.

Superior Quality Paint
Shiny, scratch-resistant paint.



Double Wall Frame
Drawers and slides function as normal even if the frame gets damaged.



Enhanced Precision Wheels
Robust wheels, two fixed and two swivelling with brakes. Good stability, easy to move and secure with non marking rubber.

Dimensions:
125 x 50 mm (26" trolleys)
150 x 50 mm (40" trolleys)

1470KXL7COLORS



1475K SERIES

40 INCHES TROLLEYS

- Suitable for Modular System
- Available in multiple colors: Orange, red, blue (dark and soft), green, purple and black
- From 5 drawers to 8 drawers in any color
- Can be developed in any RAL color

RANGE OF 26" AND 40" TROLLEYS

CODE	DESCRIPTION
1475K8PAW	8 PRO TOOL TROLLEY MIKA GREEN
1475K8PC	8 DRAW.PRO TOOL TROLLEY BLACK
1475K8PCM	8 PRO TOOL TROLLEY ROYALBLUE
1475K8PDG	8 PRO TOOL TROL.MID NIGHT BLUE
1475K8PEV	8 PRO TOOL TROLLEY PURPLE
1475K8PJJ	8 PRO TOOL TROL. EXTREME GREEN
1475K8PSP	8 DRAW.PRO TOOL TROLLEY ORANGE
1475K8PSV	8 PRO TOOL TROLLEY CARMINERED
1475KXL12PAW	12DR XL TROLLEY-MIKA GREEN
1475KXL12PC	12DR XL TROLLEY-BLACK
1475KXL12PCM	12DR XL TROLLEY-ROYAL BLUE
1475KXL12PDG	12DR XL TROLLEY-MIDNIGHT BLUE
1475KXL12PEV	12DR XL TROLLEY-PURPLE
1475KXL12PJJ	12DR XL TROLLEY-EXTREME GREEN
1475KXL12PSP	12DR XL TROLLEY-ORANGE
1475KXL12PSV	12DR XL TROLLEY-RED
1475KXL6PAW	XL6 PRO TOOL TROLLEY MIKAGREEN

RANGE OF 40" TROLLEYS

CODE	DESCRIPTION
1475KXL6PC	XL6 DRAWERS P TOOL TROL.BLACK
1475KXL6PCM	XL6 PRO TOOL TROLLEY ROYALBLUE
1475KXL6PDG	XL6 PRO T TROLLEY MIDNIGHTBLUE
1475KXL6PEV	XL6 PRO TOOL TROLLEY PURPLE
1475KXL6PJJ	XL6 PRO T TROLLEY EXTREMEGREEN
1475KXL6PSP	XL6 PRO TOOL TROLLEY ORANGE
1475KXL6PSV	XL6 P TOOL TROLLEY CARMINERED
1475KXL7PAW	XL7 PRO TOOL TROLLEY MIKAGREEN
1475KXL7PC	XL7 PRO TOOL TROLLEY BLACK
1475KXL7PCM	XL7 PRO TOOL TROLLEY ROYALBLUE
1475KXL7PDG	XL7 PRO T TROLLEY MIDNIGHTBLUE
1475KXL7PEV	XL7 PRO TOOL TROLLEY PURPLE
1475KXL7PJJ	XL7 PRO T TROLLEY EXTREMEGREEN
1475KXL7PSP	XL7 PRO TOOL TROLLEY ORANGE
1475KXL7PSV	XL7 P TOOL TROLLEY CARMINERED

ACCESSORIES

CODE	DESCRIPTION
1470K-ACTD	26" MDF TOP
1470K-ACTW	26" WOODEN TOP
1470K-ACTSS	26" STAINLESS STEEL TOP
1470KXL-ACTD	40" MDF TOP
1470KXL-ACTW	40" WOODEN TOP
1470KXL-ACTSS	40" STAINLESS STEEL TOP
1470K-AC1	FOLDABLE TRAY X 1470 & 1475
1470K-AC2	PRY BAR/SD BOX x 1470K & 1475K
1470K-AC3	CAN HOLDER X 1470K & 1475K
1470K-AC4	DOC HOLDER X 1470K & 1475K
1470K-ACSIDE	SLOTS & DOTS SIDE PANEL
1470KAC01	DRAWER LINERS SET-7 UNITS

SPARE PARTS

CODE	DESCRIPTION
1475K-01	SLIDES (X2) 45KG CAPACITY
1475K-02	SWIWEL WHEELS (X2) 125X50MM
1475K-03	FIXED WHEELS (X2) 125X50MM
1475K-08	LOCK & GO LATCH X 26" - 1PC
1475K-081	LOCK & GO LATCH X 40" - 1PC
1475K-082	LOCK & GO LATCH X 11" - 1PC
1475KXL-02	SWIWEL WHEELS (X2) 150X50MM
1475KXL-03	FIXED WHEELS (X2) 150X50MM

1470KC SERIES

ROLL CARTS



- 3 drawers & 2 trays roll cart
- Large foldable tray included: 435 x 425 mm
- Pry bar / screwdriver key locked box included: 23 holes with divers diameters
- Manufactured and designed for easy and quick assembly
- Strong and secure round type key and locking mechanism with same combination in roll cart and pry bar/ screwdrivers box
- Wheels of 100 x 25 mm with ball bearings and non-marking TPR out surface
- 2 swivel, 2 swivel with brake
- Large capacity drawers with click/detent system and 100% opening ball bearings
- Drawers can be lock from the upper tray
- Drawers internal dimensions:
 - (2x) 675 x 375 x 50 mm
 - (1x) 675 x 375 x 110 mm
- Upper tray with 2 gas springs lid that provides a large working surface of 700 x 440 mm
- Upper and bottom trays´ internal dimensions:
 - (2x) 755 x 425 x 77 mm
- 1470KC5: Orange
- 1470KC5PC: Black



Internal drawer locking



2 gas springs



Aluminium U shape two structures



Stable wheels with break



Click/detent system and 100% opening ball bearings



Large foldable tray



Round key locking system

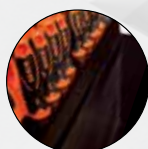

Lockable tool holder



1470KC5		1315x440x1025	675x375x40	30	25x100	50	■
1470KC5PC		1315x440x1025	675x375x40	30	25x100	50	■

1470KC SERIES

ROLL CARTS

- 3 and 2 trays roll cart
- Large capacity trays for storing small and bulky objects
- Manufactured and designed for easy and quick assembly
- Aluminum U shape two structures
- Wheels of 25 x 100 mm with ball bearings and non-marking TPR out surface
 - 2 swivel
 - 2 swivel with brake
- Trays internal dimensions:
 - (3X) 750 x 425 x 77 mm

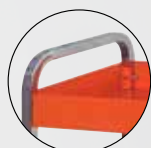

Aluminium U shape two structures



Stable wheels with break



Icon	#	Dimensions (mm)	Dimensions (mm)	Capacity (kg)	Wheel Dimensions (mm)
	3	1315x440x1025	675x375x40	50	25x100
	2	1315x440x1025	675x375x40	50	25x100
	1	757x428x77	757x425x77	50	-

SPARE PARTS

CODE	DESCRIPTION
1470KC2-02	SWIWEL WHEELS W/ BRAKE (X2) 100X25MM
1470KC2-03	SWIWEL WHEELS (X2) 100X25MM
1470KC5-01	SLIDES (X2) 30KG CAPACITY

1483K SERIES METALLIC CASES

- Big capacity but compact case combining drawers for small tools and the upper tray for medium size ones
- The lid is reinforced externally with an aluminium plate and internally within a metallic grid that also stands the clips for hammers or the other long tools
- The lid handle and the lateral ones allow the case to be handled by two persons and make its transport easy and comfortable even when very loaded
- The case can be secured with standard locks thanks to the lid closing metallic latches that are having the O for them
- Double wall frame protects the slides and drawers from shocks/crashes
- Reinforced areas to reduce stress in specific points of the case
- Long ball bearing slides with 100% opening drawers
- Click/detent closing system of drawers
- Due to an internal system, the drawers are locked when the lid is closed
- Drawers internal dimensions:
 - (4x) 455x208x39 mm
- Upper tray internal dimensions:
 - (1x) 520x250x60 mm



ERGO TOOL MANAGEMENT SYSTEM



100% opening drawers



Under lid grid for tool holding clips



Lid handle for transport in confined spaces



Aluminium plate reinforcement of lid

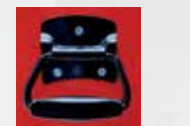

Strong lateral handles for easy transport



Drawer blocking system



1483K2RB



1483K3RB



1483KHD3RB



1483KHD4RB



1483KCART

1483K SERIES

METALLIC CASES

- Big capacity but compact case combining drawers for small tools and the upper tray for medium size ones
- The lid is reinforced externally with an aluminium plate and internally within a metallic grid that also stands the clips for hammers or the other long tools
- The lid handle and the lateral ones allow the case to be handled by two persons and make its transport easy and comfortable even when very loaded
- The case can be secured with standard locks thanks to the lid closing metallic latches that are having the O for them
- Double wall frame protects the slides and drawers from shocks/crashes
- Reinforced areas to reduce stress in specific points of the case
- Long ball bearing slides with 100% opening drawers
- Click/detent closing system of drawers
- Due to an internal system, the drawers are locked when the lid is closed
- Drawers internal dimensions
 - (4x) 455x208x39 mm
- Upper tray internal dimensions:
 - (1x) 520x250x60 mm



	#	mm	mm		kg
1483K2RB	2	523x257x247	455x208x39	520x250x60	9,00
1483K3RB	3	523x257x300	455x208x39	520x250x60	10,00
1483KHD3RB	3	523x257x300	455x208x39	520x250x60	11,00
1483KHD4RB	4	523x257x353	455x208x39	520x250x60	12,00

SPARE PARTS

CODE	DESCRIPTION
1483K2-01	SLIDES (X2) KG CAPACITY
1483KHD3-15	FOLDABLE HANDLES (X2)
1483KHD3-20	LID HOOK SET

4750RCHD SERIES

INDESTRUCTIBLE TOOL CASE WITH INJECTED COPOLYMER POLYPROPYLENE

- Reinforced angles and ribs for maximum protection
- Corrosion, water and dust proof - all parts are Skydrol resistant
- Extremely resistant to very low and high temperature: -33° to 90°
- Airtight PU injected O-ring seal
- Manual air pressure valve
- Stainless steel pins
- Integrated identification / name badge
- Padlockable
- Interstackable



ERGO TOOL MANAGEMENT SYSTEM



Air pressure valve



Stackable



Lockable



Shoulder strap
4750RCHD01



Wheels
4750RCHDW01 &
4750RCHDW02



Handle and
identification badge



Telescopic handle
4750RCHDW01 &
4750RCHDW02



Latches



4750RCHDW02

4750RCHD01

4750RCHDW01

4750RCHD00

ACCESSORIES

Removable Lid Panel



4750RCHD01AC1
Accessory for 4750RCHD01

4750RCHDW01AC1
Accessory for 4750RCHDW01

Removable Padded Bag:



4750RCHD01AC2
Accessory for 4750RCHD01

4750RCHDW01AC2
Accessory for 4750RCHDW01

TSA approved Lock



4750RCHD-AC1
Accessory for all
4750RCHD cases

475ORCHD SERIES

INDESTRUCTIBLE TOOL CASE WITH INJECTED COPOLYMER POLYPROPYLENE



- Reinforced angles and ribs for maximum protection
- Corrosion, water and dust proof - all parts are Skydrol resistant
- Extremely resistant to very low and high temperature: -33° to 90°
- Airtight PU injected O-ring seal
- Manual air pressure valve
- Stainless steel pins
- Integrated identification / name badge
- Padlockable
- Interstackable

ACCESSORIES

CODE	DESCRIPTION
475ORCHD01AC1	LID PANEL X 475ORCHD01
475ORCHD01AC2	INTERNAL BAG X 475ORCHD01
475ORCHDW01AC1	LID PANEL X 475ORCHDW01
475ORCHDW01AC2	INTERNAL BAG X 475ORCHDW01
475ORCHD-AC1	TSA LOCK X 475ORCHD CASES

475ORCHD00		A	Int. / Ext. 380 / 410 B 270 / 340 C 180 / 205 D 45 E 135	✓	X	3,15	18,5
475ORCHD01		A	Int. / Ext. 445 / 474 B 345 / 415 C 190 / 214 D 47 E 143	475ORCHD01 ✓	X	4	29,2
475ORCHD01		A	Int. / Ext. 445 / 474 B 345 / 415 C 190 / 214 D 47 E 143	475ORCHD011 ✓	X	6,5	29,2
475ORCHDW01		A	Int. / Ext. 517 / 546 B 277 / 347 C 217 / 247 D 50 E 167	✓	✓	6	31,0
475ORCHDW02		A	Int. / Ext. 538 / 627 B 405 / 475 C 250 / 292 D 60 E 190	X	✓	10	53,01

4750RCWD4

RIGID CASE ON WHEELS



ERGO TOOL MANAGEMENT SYSTEM

- Case made of Copolymer Polypropylene (PP) compound/ resin, provides an excellent capacity to impacts and performance even under extreme conditions
- The whole case can be locked by using a padlock. Central one is metal reinforced but there are various others for completely securing the case. Use the BAHCO padlock 4750RCHD-AC1
- Top compartment is the biggest storage area of the case and it is covered by a lid that it is secured by 2 latches. Can be under locked using the key
- Top compartment is the biggest storage area of the case and it is covered by a lid that it is secured by 2 latches. Can be under locked using the key
- Bottom compartment is protected by a door which is secured by 2 latches. Can be folded 167° making its opening easy when it is on a table
- Central key lock: secures top and bottom compartments. 200 different lock combinations
- Embossed BAHCO logo on the bottom compartment front cover for brand building. Can be opened 167° down and remove if necessary

CODE	DESCRIPTION
4750RCWD4	CASE ON WHEELS 4 DR
4750RCWD	CASE W/O DRAWERS
4750RCWDD1	30MM DR X 4750RCWD- 1 SLOT
4750RCWDD2	60MM DR X 4750RCWD- 2 SLOTS
4750RCWDD3	95MM DR X 4750RCWD- 3 SLOTS
4750RCWDD4	PORTABLE TRAY
4750RCWD-AC1	4 PIVOT WHEELS X 4750RCWD
4750RCWD-AC2	LID PALLET W/ POUCHES
4750RCWD-AC3	LID PALLET W/ ELASTICS
4750RCWD-AC4	LID PERF. PALLET W/ ELASTICS & CLIPS
4750RCHD-AC1	TSA LOCK X 4750RCHD CASES

SPARE PARTS

CODE	DESCRIPTION
4750RCWD4-01	TELESCOPIC HANDLE
4750RCWD4-02	FEET (X2)
4750RCWD4-03	PAIR OF TWIN WHEELS
4750RCWD4-04	CENTRAL LOCK W/ 2 KEYS
4750RCWD4-07	LATCH X 1



4750RCWD4 RIGID CASE ON WHEELS



ERGO TOOL MANAGEMENT SYSTEM

- The case includes a portable tray which is very practical for taking just the needed tools and bringing them to the needed place
 - Specific protected space for case identification
 - 8 drawer slots: the case is provided following the configuration you can see but the drawers' position can be easily change due to case's 8 slots. There are no sliders, the drawers work by friction having latches that avoid the drawers to fell out accidentally
 - Top compartment is the biggest storage area of the case and it is covered by a lid that it is secured by 2 latches. Can be under locked using the key
 - Lateral big handles on the sides: are very practical for when lifting the case as well as for when pulling it when it is stored within a corner, van, etc.
 - Drawer handles: pivoting system and very flat for space reasons, make the opening of the drawers easy even when wearing gloves
- Under lid optional pallets: the User can separately personalized its case by getting different under lid pallets options we offer. They are easy to assembly and cover different needs

Pivoting under lid pallet options:



4750RCWD-AC2
Pouch system



4750RCWD-AC3
Fixed elastics



Under lid Fixed pallet option:
4750RCWD-AC4 Adjustable elastics

Swiveling wheels kit accessory: 4750RCWD-AC1

- By removing the front feet, 4 swiveling wheels can be assembly
- making its driving even easier when working in flat floors
- Increases the height in 45mm.
- For safety, 2 of them include brake.
- Dim: 50x18mm
- Hub: Polyamide
- Tyre: Polyurethane



4750RC SERIES

RIGID TOOL CASES

- 2 metal locks with keys
- 2 metal lid safety support stays
- 1 pallet positioning rubber strip
- 3 metal hinges for maximum strenght
- Rubber coated heavy duty handle
- Document area
- Bottom area with removable dividers
- Identification label in one of the case side
- 1 lid tool pallet:
 - 4750RC02: With elastic pouches
 - 4750RC021: With rubber strips on two sides
- 1 bottom tool pallet:
 - 4750RC02: With transparent pouches on one side
 - 4750RC021: With rubber strips on one side



4750RC02
and **4750RCW01**
Plastic Pouches



4750RC021
and **4750RCW011**
Rubber Strips



4750RC01



4750RCW01 / 4750RCW011 **4750RC02 / 4750RC021**

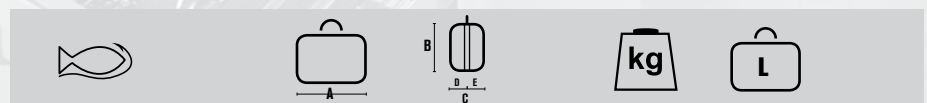

	A	B	C	D	E	kg	L
4750RC01	430	340	156	78	78	3	23
4750RC02	465	352	215	95	120	5	35
4750RC021	465	352	215	95	120	5	35
4750RCW01	465	352	215	95	120	5,5	42
4750RCW011	465	352	215	95	120	5,5	42

4750RC SERIES

RIGID TOOL CASES



ERGO TOOL MANAGEMENT SYSTEM

CODE	DESCRIPTION	CASES AFFECTED	
4750RC01-01	HANDLE x 4750RC01	4750RC01	
4750RC01-04	LOCK + 2 KEYS	4750RC01	
4750RC01-06	UPPER PALLET W/ ELASTICS	4750RC01	
4750RC01-05	LOWER PALLET W/ ELASTICS	4750RC01	
4750RC01-07	LATCHES X 2	4750RC01	
4750RC02-01	HANDLE X 4750RC02 & RCW01	4750RC02/021	
		4750RCW01/011	
4750RC02-04	LOCKS + 2 KEYS	4750RC02/021	
		4750RCW01/011	
4750RC02-051	UPPER PALLET W/ RUBBER STRIPS	4750RC021	
		4750RCW011	
4750RC02-052	UPPER PALLET W/ POUCHES	4750RC02	
		4750RCW01	
4750RC02-061	LOWER PALLET W/ RUBBER STRIPS	4750RC021	
		4750RCW011	
4750RC02-062	LOWER PALLET W/ POUCHES	4750RC021	
		4750RCW011	
4750RC02-07	RUBBER STRIP_PALLET HOLDER	4750RC02/021	
		4750RCW01/011	
4750RC02-08	LID METALLIC SUPPORTS	4750RC02/021	
		4750RCW01/011	
4750RCW01-09	BOTTOM DIVIDERS	4750RCW01/011	
4750RC02-09	BOTTOM DIVIDERS	4750RC02/021	
4750RCW01-01	TELESCOPIC HANDLE	4750RCW01/011	
4750RCW01-03	WHEELS KIT X 2	4750RCW01/011	
		4750RCHD00	
4750RCHD-01	HANDLE X 4750RCHD	4750RCHD01	
		4750RCHD011	
		4750RCHDW01	
		4750RCHD011-05	
4750RCHD011-06	UPPER PALLET W/ RUBBER STRIPS	4750RCHD011	
4750RCHD-07	LATCH X1	4750RCHD011-06	
		4750RCHD00	
		4750RCHD01	
		4750RCHD011	
4750RCHDW01	4750RCHDW01	4750RCHDW02	4750RCWD4
4750RCHD011-09	BOTTOM DIVIDERS	4750RCHD011	
4750RCHDW01-01	EXTRACTABLE HANDLE X 4750RCHDW01	4750RCHDW01	
4750RCHDW01-03	WHEELS KIT X 2 & AXEL	4750RCHDW01	
4750RCHDW02-01	EXTRACTABLE HANDLE & WHEELS X 4750RCHDW02	4750RCHDW02	
4750RCHDW02-011	SIDE HANDLE	4750RCHDW02	4750RCWD4
4750RCHDW02-03	WHEELS KIT X 2	4750RCHDW02	
4750RCWD4-07	LATCH X 1	4750RCWD/4	
4750RCWD4-04	CENTRAL LOCK W/ 2 KEYS	4750RCWD/4	
4750RCWD4-01	TELESCOPIC HANDLE	4750RCWD/4	
4750RCWD4-03	PAIR OF TWIN WHEELS	4750RCWD/4	
4750RCWD4-02	FEET (X2)	4750RCWD/4	
4750RCWD1	30MM DR X 4750RCWD-1 SLOT	4750RCWD	
4750RCWD2	60MM DR X 4750RCWD-2 SLOTS	4750RCWD	
4750RCWD3	95MM DR X 4750RCWD-3 SLOTS	4750RCWD	
4750RCWD4	PORTABLE TRAY	4750RCWD	
4750RCWD-AC1	4 PIVOT WHEELS X 4750RCWD	4750RCWD/4	
4750RCWD-AC2	LID PALLET W/POUCHES	4750RCWD/4	
4750RCWD-AC3	LID PALLET W/ELASTICS	4750RCWD/4	
4750RCWD-AC4	LID PERFO. PALLET W/ELASTICS	4750RCWD/4	

■ 1495C SERIES

CABINET WITH SHUTTER

- **Compact structure:** The depth of 170mm is good enough for storing tools but, at the same time, very compact
- **Dimensions:** 1.500 x 170 x 900 mm / 1.800 x 170 x 900 mm
- **Accessories:** A comprehensive kit of hooks is available for making the decision easy to the User. 1495CS-AC1 includes 35 different hooks which is a good base for the majority of the users
- **Rolling system:** The shutter is rolled in the top side of the frame and can be easily rolled down using the 2 handles available



CODE	DESCRIPTION
1495CS15	cabinet w/ shutter 1500 mm
1495CS18	cabinet w/ shutter 1800 mm
1495CS-AC1	Hook set- 35P

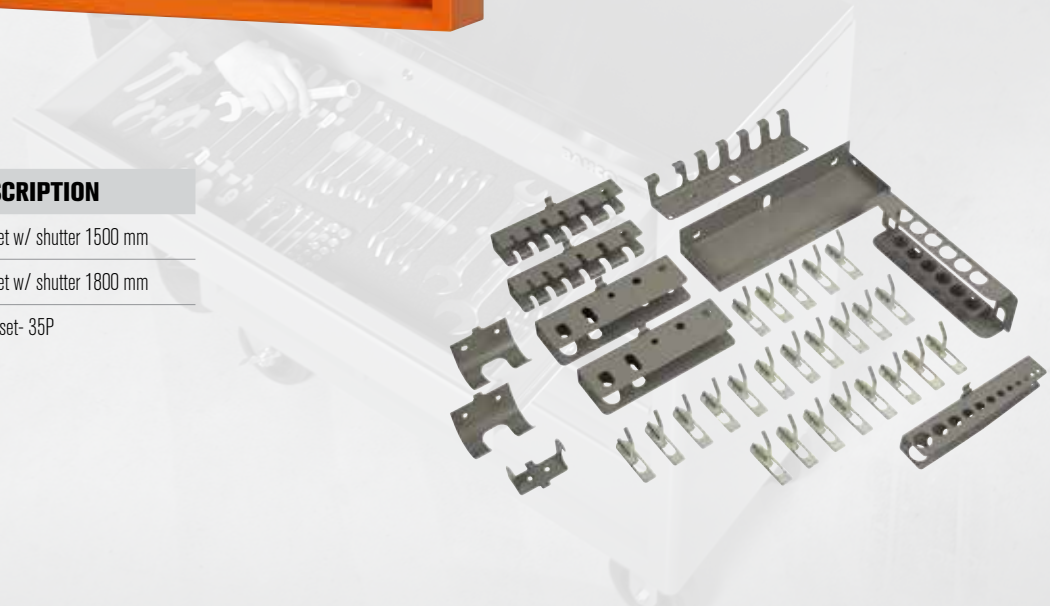

1495TP SERIES TOOL PANEL



ERGO TOOL MANAGEMENT SYSTEM

- **Sturdy frame:**
The panel is having a frame which is bended in the edges in order to be able to stand to be mounted in walls (comes with hardware for that) and stands big loads without having any deformation
- **Four dimensions available:**
 - 600x25x500 mm
 - 1.200x25x800 mm
 - 1.500x25x800 mm
 - 1.800x25x800 mm
- **Accessories:** 1495CS-AC1 includes 35 different hooks which is a good base for the majority of the Users
- 1495TP-AC1 accessory is used for attaching the tool panels to workbenches with wooden or MDF tops

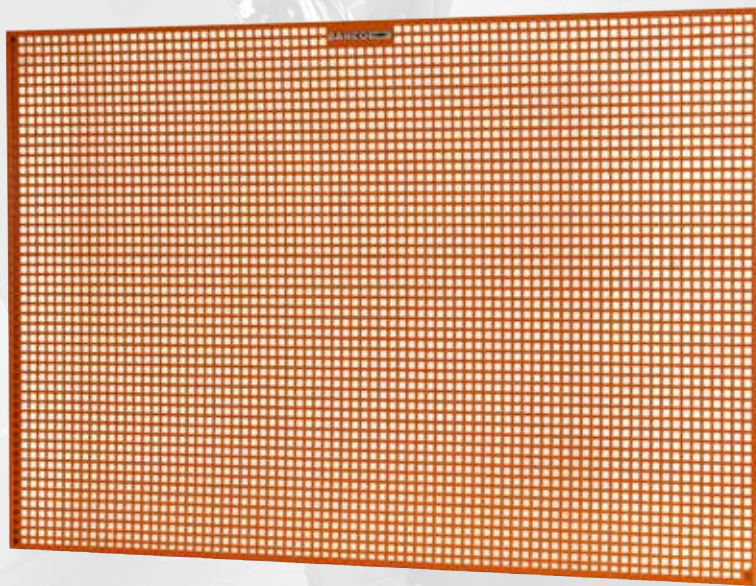

CODE	DESCRIPTION
1495TP06	Tool panel 600x25x500 mm
1495TP12	Tool panel 1200x25x800 mm
1495TP15	Tool panel 1500x25x800 mm
1495TP18	Tool panel 1800x25x800 mm
1495TP-AC1	Tool panel/ Workbench assembly adaptors

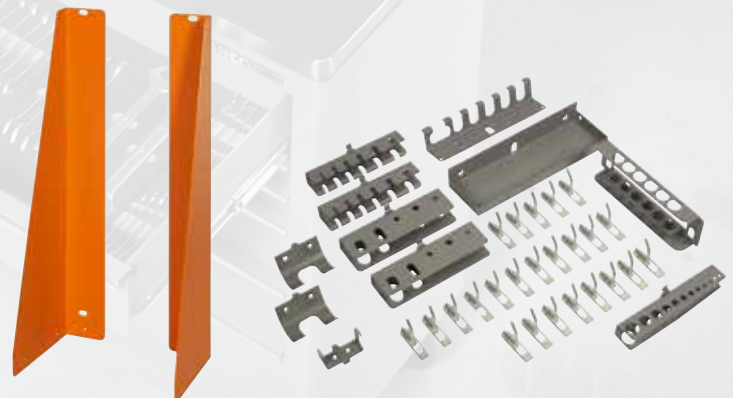

1495K SERIES WORKBENCHES



ERGO TOOL MANAGEMENT SYSTEM

- Load capacity: 1,5T: Spread along the working surface
- Dimensions: the 2 options available are for professional use providing big working surfaces
 - 1.500 x 750 x 1.030 mm
 - 1.800 x 750 x 1.030 mm
- Feet:
 - U shape of provides robustness
 - The H shape welded feet
 - Brings strength and robustness
 - Flat shape end
 - Vulcanized rubber
 - Holes
- Free space can be used for storing 1470/75K BAHCO trolleys
- Chestnut or MDF top options: 40mm thickness
- Drawer tower based on the trolley assortment we have: 5, 6, 7 and 8 drawers within orange, blue, red or black colors
- Trolley adaptor for lifting the trolley to the necessary height. Provides big stability



		1500 MM				1800 MM			
		Orange	Red	Black	Blue	Orange	Red	Black	Blue
MDF	5	1495K5WB15TD	1495K5REDWB15TD	1495K5BKW15TD	1495K5BLWB15TD	1495K5WB18TD	1495K5REDWB18TD	1495K5BKW18TD	1495K5BLWB18TD
	6	1495K6WB15TD	1495K6REDWB15TD	1495K6BKW15TD	1495K6BLWB15TD	1495K6WB18TD	1495K6REDWB18TD	1495K6BKW18TD	1495K6BLWB18TD
	7	1495K7WB15TD	1495K7REDWB15TD	1495K7BKW15TD	1495K7BLWB15TD	1495K7WB18TD	1495K7REDWB18TD	1495K7BKW18TD	1495K7BLWB18TD
	8	1495K8WB15TD	1495K8REDWB15TD	1495K8BKW15TD	1495K8BLWB15TD	1495K8WB18TD	1495K8REDWB18TD	1495K8BKW18TD	1495K8BLWB18TD
WOODEN	5	1495K5WB15TW	1495K5REDWB15TW	1495K5BKW15TW	1495K5BLWB15TW	1495K5WB18TW	1495K5REDWB18TW	1495K5BKW18TW	1495K5BLWB18TW
	6	1495K6WB15TW	1495K6REDWB15TW	1495K6BKW15TW	1495K6BLWB15TW	1495K6WB18TW	1495K6REDWB18TW	1495K6BKW18TW	1495K6BLWB18TW
	7	1495K7WB15TW	1495K7REDWB15TW	1495K7BKW15TW	1495K7BLWB15TW	1495K7WB18TW	1495K7REDWB18TW	1495K7BKW18TW	1495K7BLWB18TW
	8	1495K8WB15TW	1495K8REDWB15TW	1495K8BKW15TW	1495K8BLWB15TW	1495K8WB18TW	1495K8REDWB18TW	1495K8BKW18TW	1495K8BLWB18TW

1495WB SERIES WORKBENCH



- Load capacity: 1,5T: spread along the working surface
- Feet:
 - U shape of provides robustness
 - The H shape welded feet brings strength and robustness
 - Flat shape end
 - Vulcanized rubber
 - Holes
- Dimensions: 2 options available are for professional use providing big working surfaces.
 - 1.500 x 750 x 1.030 mm
 - 1.800 x 750 x 1.030 mm
- 3 different top options available:
 - **Chestnut/ wooden top:** with 40mm thickness and varnished finished for long lasting, it is the best solution cause absorbs very well impacts, lubricants, etc.
 - **MDF top:** with 40mm thickness, it is very consistent in strength and size and with similar characteristics to the chestnut but at a more affordable cost
 - **Steel top:** with 2mm thickness, it is strategically bended for making it very strong and HD. It is the sturdiest solution and, at the same time, the most affordable one

1495WB15TS

1495WB15TD

1495WB15TW

1500 x 750 x 1030 mm

1495WB18TS

1495WB18TD

1495WB18TW

1800 x 750 x 1030 mm



1495WB-AC1

500 x 500 x 105 mm

1495WB-AC2

570 x 528 x 160 mm

1495WB15-AC1

1500 x 504 x 30 mm

1495WB18-AC1

1800 x 504 x 30 mm



- Includes metallic dividers
- Can be assembled in any of the sizes
- Removable tray

■ 1495FWB SERIES

FOLDABLE WORKBENCH

- Compact structure: Scissor system: compact bridges provide strength and stability
- Plastic caps in structure's feet: Provide stability and avoids any slippery situation regardless the surface we are working on
- Plastic caps in structure top sides:
- Make the top mounting easy and tight for avoiding any movement while working
- Tops:
 - MDF combined with galvanized top
 - Galvanized top
- Two dimensions available:
 - 970 x 500 x 840 mm
 - 1.200 x 500 x 840 mm
- Load capacity: 300 kg, spread along the working surface
- Rubber handles: Large enough and protected with rubber for avoiding injuring the user



CODE	DESCRIPTION
1495FWB097TS	Foldable workbench Galvanized Top 970 x 500 x 840 mm
1495FWB120TS	Foldable workbench Galvanized Top 1200 x 500 x 840 mm
1495FWB097TD	Foldable workbench MDF + Galvanized Top 970 x 500 x 840 mm
1495FWB120TD	Foldable workbench MDF + Galvanized Top 1200 x 500 x 840 mm

■ 1495TP SERIES

TOOL PANEL ON WHEELS

- Spacious bottom compartment for storing bulky tools, products, tanks or similar
- Load capacity: 300 kg. Spread along the working surface
- Wheels with brake (2) for avoiding any unexpected movement
 - Dim: 100 x 25 mm
 - Material: anti marking rubber
- Handles in both sides for easy moving the trolley and providing more safety
- Accessories: 1495CS-AC1 includes 35 different hooks which is a good base for the majority of the users



- Tray on top: used for storing any screw, nut, etc. the user has disassembly

CODE	DESCRIPTION
1495TP10W	Tool panel on wheels 1000 x 450 x 1500mm

1495CD SERIES

CABINET WITH 2 DOORS ON WHEELS

- **Compact structure:** 1mm & 2mm sheet metal
The steel frame makes it very robust and capable to load it heavily
- **Dimensions:** 605 x 250 x 900 mm
- **Locking system:** The cabinet can be easily closed and even secured with a key
- **Built in hooks inside doors:** the doors are opened 180° for full access
- **Perforated panel on sides:**
Built in drawer provides a closed space where the User can store any specific tools/ thing.
100% opening slides provide full access



HOOKS AND ACCESSORIES ASSORTMENT

CODE	DESCRIPTION
1495CD60	Tool cabinet w / 2 doors
1495CD60W	Tool cabinet w/ 2 door & on wheels
1495CD-AC1	Hook set- 24P

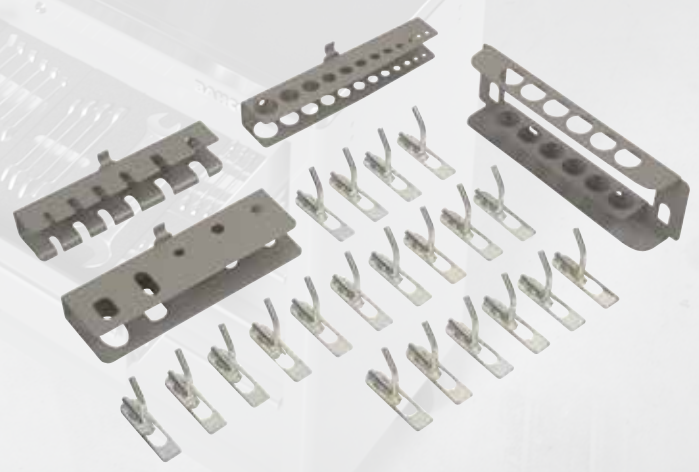

1495TP SERIES TOOL PANEL ON WHEELS

- Spacious bottom compartment for storing bulky tools, products, tanks or similar
- Load capacity: 300 kg. Spread along the working surface
- Wheels with brake (2) for avoiding any unexpected movement
 - Dim: 100 x 25 mm
 - Material: anti marking rubber
- Handles in both sides for easy moving the trolley and providing more safety
- Accessories: 1495CS-AC1 includes 35 different hooks which is a good base for the majority of the users

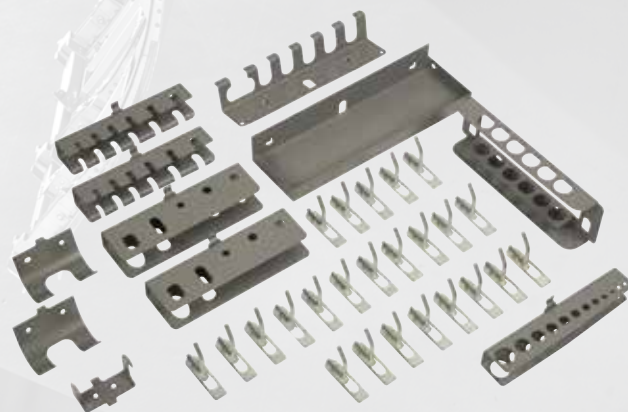

HOOKS AND ACCESSORIES ASSORTMENT

CODE	DESCRIPTION	CODE	DESCRIPTION
1495TP-ACHL20	HOOK 20MM L- 1 SLOT	1495TP-AC5	SCREWDRIVERS HOOK- 6 SLOTS
1495TP-ACHL40	HOOK 40MM L- 1 SLOT	1495TP-AC6	PLIERS HOOK- 5 SLOTS
1495TP-ACHL65	HOOK 65MM L- 1 SLOT	1495TP-AC7	GRIP HOOK- 1 SLOT
1495TP-ACHL90	HOOK 90MM L- 1 SLOT	1495TP-AC8	ALLEN KEYS HOOK- 12 SLOTS
1495TP-ACHU20	HOOK 20MM U- 1 SLOT	1495TP-AC9	DOUBLE SOCKET WR HOOK-12 SLOTS
1495TP-ACHU40	HOOK 40MM U- 1 SLOT	1495TP-AC10	OPEN END WRENCH HOOK-12 SLOTS
1495TP-ACHU65	HOOK 65MM U- 1 SLOT	1495TP-AC11	PIN PUNCHES HOOK- 6 SLOTS
1495TP-ACHU90	HOOK 90MM U- 1 SLOT	1495TP-AC12	HAMMER HOLDER- 1 SLOT
1495TP-AC2	TRAY 1	1495TP-AC13	T HANDLE HOOK- 1 SLOT
1495TP-AC3	TRAY 2- FOR SOCKETRY		
1495TP-AC4	TRAY 3-PLASTIC		

4750FB1-19A

NEW GENERATION OF SOFT BAGS

- 600 Denier polyester: used in areas with no risk of damaging the bag with a tip or any tool part. Provides flexibility and lightweight
- 1680 Denier polyester: used in areas with big risk of damaging the bag with a tip or sharp edge. Also in areas that need to be better protected against frictions or because they will stand big loads
- 100% Waterproof and anti slippery plastic hard bottom included in all the bags; provides big strength to the bag and protection against impacts thanks to the double stitching reinforcement
- HD PVC zips



Velcro straps for long tools:
Spirit levels, tubes and similar longer material can be stored using those straps with the quick velcro system positioned in both upper side of the bag

Soft grip handle:
Made of rubberized material. Provides a user friendly grip and isolates from touching any cold material



Measuring tape, card holder & phone pocket on one side

Hand saw special pocket:
With a zip and velcro strap for a quick storage, avoids any accident and / or lost during transport

HARD BOTTOM
100% waterproof

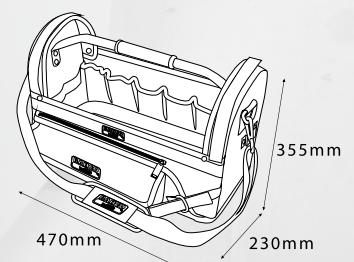

4750FB1-19B

NEW GENERATION OF SOFT BAGS

- 600 Denier polyester: used in areas with no risk of damaging the bag with a tip or any tool part. Provides flexibility and lightweight
- 1680 Denier polyester: used in areas with big risk of damaging the bag with a tip or sharp edge. Also in areas that need to be better protected against frictions or because they will stand big loads
- 100% Waterproof and anti slippery plastic hard bottom included in all the bags; provides big strength to the bag and protection against impacts thanks to the double stitching reinforcement
- HD PVC zips



Velcro straps for rolling the cover: keeps the bag open when necessary but, at the same time, the handsaw and other pockets can be still used

Screwdriver section: with elastics for keeping those tools always at hand

Soft grip handle made of rubberized material provides a user friendly grip and isolates from touching any cold material

Measuring tape, card holder & phone pocket on one side

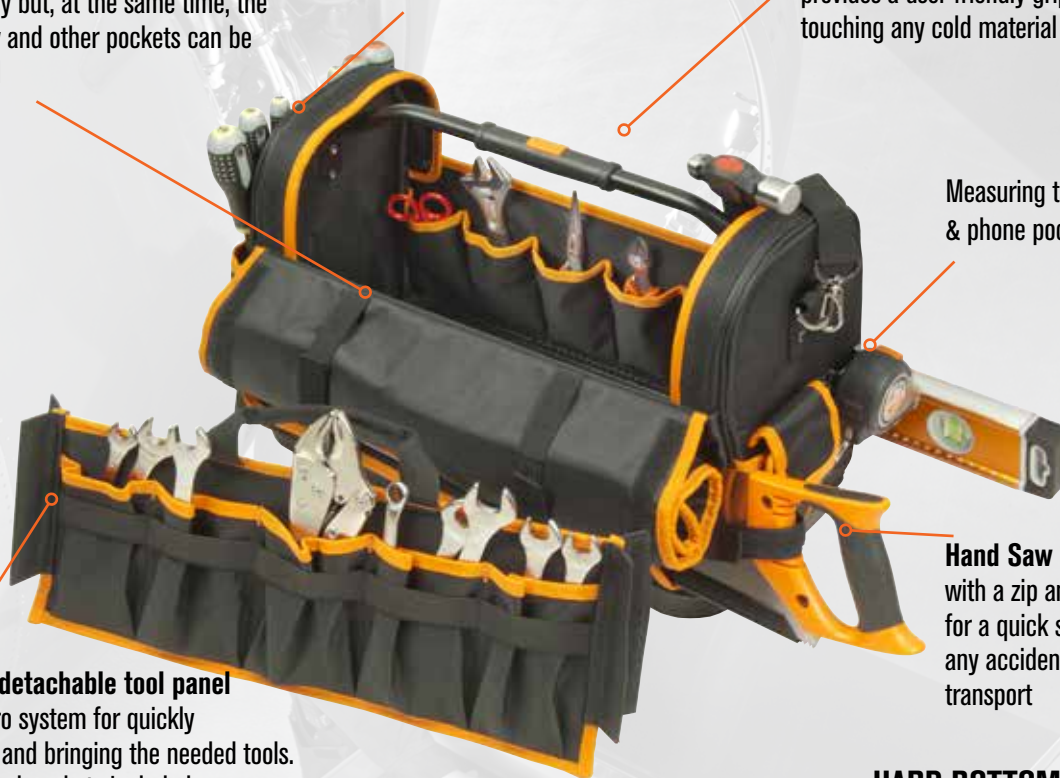

Internal detachable tool panel with velcro system for quickly removing and bringing the needed tools. Elastics and pockets included

Hand Saw special pocket: with a zip and velcro strap for a quick storage, avoids any accident and / or lost during transport

HARD BOTTOM
100% waterproof



Softgrip handle access trough the cover

Velcro straps for long tools

Spirit level elastics
Holders on back side

Hard bottom: 100% waterproof

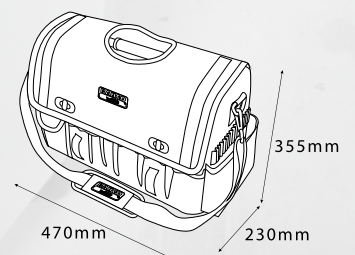

4750FB2W-24A

NEW GENERATION OF SOFT BAGS

- 600 Denier polyester: used in areas with no risk of damaging the bag with a tip or any tool part. Provides flexibility and lightweight
- 1680 Denier polyester: used in areas with big risk of damaging the bag with a tip or sharp edge. Also in areas that need to be better protected against frictions or because they will stand big loads
- 100% Waterproof and anti slippery plastic hard bottom included in all the bags; provides big strength to the bag and protection against impacts thanks to the double stitching reinforcement
- HD PVC zips



Multiple screwdrivers
Internal pocket section

Handsaw internal
zipped pocket

Under lid net zipped
pocket for documents

10" Tablet
size specific pocket

Elastic & velcro quick
adjustable straps
for long tools such as
spirit levels, tubes . . .

Side horizontal handles: for
easier pulling the bag when stored
in confine places, pic ups, etc

Side big pouches:
Left one zipped detachable
Right fixed one includes
a plastic box for small
consumables: screws,
nuts, washers, terminals

HARD BOTTOM
100% waterproof



Telescopic handle:
960 mm max

Externally positioned pu
80 x 25 mm wheels:
For better stability and
Silent when rolling

Card holder

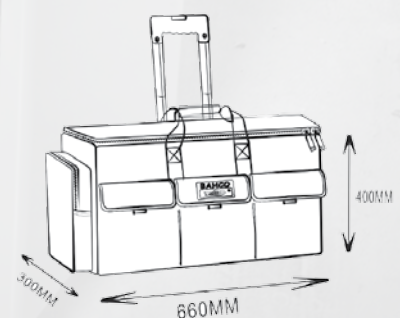

4750FB SERIES

NEW GENERATION OF SOFT BAGS

- 600 Denier polyester: used in areas with no risk of damaging the bag with a tip or any tool part. Provides flexibility and lightweight
- 1680 Denier polyester: used in areas with big risk of damaging the bag with a tip or sharp edge. Also in areas that need to be better protected against frictions or because they will stand big loads
- 100% Waterproof and anti slippery plastic hard bottom included in all the bags; provides big strength to the bag and protection against impacts thanks to the double stitching reinforcement
- HD PVC zips



ERGO TOOL MANAGEMENT SYSTEM

HARD BOTTOM

100% waterproof



4750FB2-19A / 4750FB2-24A

Multiple internal and external pockets

Double heavy duty zips

4 practical pockets on one side

Handsaw internal holder (tip protector & handle velcro holder)

Quick adjustable straps for long tools such as spirit levels, tubes...

Measuring tape, card holder & phone pocket on one side



4750FB5A, 4750FB5B & 4750FB5C



- Measuring tape holder
- Rubber soft handle
- Multiple elastics for tool distribution in the bottom and upper side
- Card holder on front and labelling holder on the side for quick identification

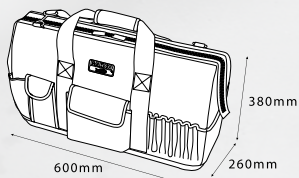

4750FB3-12

NEW GENERATION OF SOFT BAGS

- 600 Denier polyester: used in areas with no risk of damaging the bag with a tip or any tool part. Provides flexibility and lightweight
- 1680 Denier polyester: used in areas with big risk of damaging the bag with a tip or sharp edge. Also in areas that need to be better protected against frictions or because they will stand big loads
- 100% Waterproof and anti slippery plastic hard bottom included in all the bags; provides big strength to the bag and protection against impacts thanks to the double stitching reinforcement
- HD PVC zips



Multiple screwdrivers elastic section
In front and back side

Divers height pockets
replicated in both sides

HD reinforced handle
provides stability and strength the bag

Central big compartment
for bigger tools or material

Measuring tape, card holder & phone pocket on one side

Big bottom pocket
Including a plastic box for small consumables: screws, nuts, washers, terminals

HARD BOTTOM
100% waterproof



4750FB4-18

NEW GENERATION OF SOFT BAGS

- 600Denier polyester: used in areas with no risk of damaging the bag with a tip or any tool part. Provides flexibility and lightweight
- 1680Denier polyester: used in areas with big risk of damaging the bag with a tip or sharp edge. Also in areas that need to be better protected against frictions or because they will stand big loads
- 100% Waterproof and anti slippery plastic hard bottom included in all the bags; provides big strength to the bag and protection against impacts thanks to the double stitching reinforcement
- HD PVC zips



ERGO TOOL MANAGEMENT SYSTEM

HARD BOTTOM

100% waterproof



Divers height pockets and sections in each compartment allows a better tool distribution and to bring only one to the work place for avoiding carrying a heavy bag

Central big padded compartment for laptop and similar delicate material and **two detachable side sections**



Measuring tape, card holder & phone pocket on one side

Side detachable compartment: **each one has its own design** for better covering the needs of each user

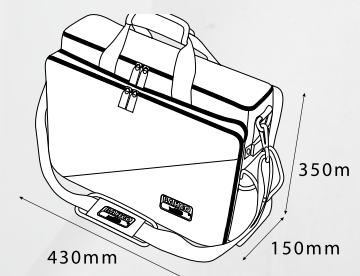

MASON BOX

- Internal protection using a 3,2 mm thick plywood with anti- humidity treatmen
- HD constructions with weld points in key areas for making the box robust
- Combination of 0.8 mm and 1.0 mm thickness steel on the stressed areas for avoiding any deformation
- All boxes are including a tool tray which helps the User to carry the needed tools
- Orange powder coating with a texture finishing that is more resistant to the toughest working environments
- Lid opening system, with L formed brackets on the back side, avoids any unexpected tilting of the box
- Document holder under the lid helps to keep papers and documents clean in the dirty environments those boxes are usually used
- All boxes are including a tool tray which helps the User to carry the needed tools w/o the need to move the big mason box



ERGO TOOL MANAGEMENT SYSTEM



CODE	DESCRIPTION
1496MB2	530x290x290
1496MB3	690x360x310
1496MB4	830x440x340
1496MB5	910x530x530

4750-EP-1
ELECTRICIAN'S POUCH

- Universal tool loop for your bigger tools to keep them organized
- Chain hook for an easy access to insulation tapes or flex
- Main deep pocket for safe storage of long tools and fixings, etc.
- Additional pocket for smaller tools gives easy tool access
- Real leather slots on the sides ideal for holding longer tools i.e. screwdrivers, knives
- Necessary equipment is at hand when needed
- Made of strong 1680 denier polyester



	METRIC
height	300 mm
length	270 mm
width	150 mm
weight	0.520 kg
volume	2.500 l



4750-DH0-3 DRILL HOLSTER RIGHT & LEFT HAND

- Holds any standard sized cordless or mains powered drill
- Suits left and right handed users as well as forward and backward facing machines
- Rubber slots on the top ideal for storing drill bits
- Genuine leather strap with a metal button holds the drill safely when climbing on or off a scaffolding



	METRIC
height	290 mm
length	170 mm
width	170 mm
weight	0.260 kg
volume	0 l

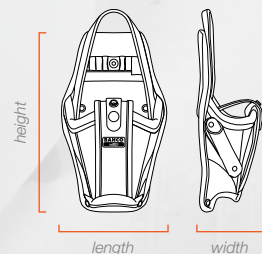

■ **4750-HHO-2**
HAMMER HOLDER

- Fits any BAHCO tool belt or normal clothing belt
- Useful while working with the hands up, when the quick access to tools is needed
- Made of strong 1680 denier polyester. Visible badge with BAHCO logo on the front of the holder. Swings to keep your hammer at a comfortable angle
- Solution with side gate lets you easily put the tool in without looking at the holder
- Keeps all kinds of common hammers used on building site



	METRIC
height	180 mm
length	120 mm
width	70 mm
weight	0,170 kg
volume	0 l

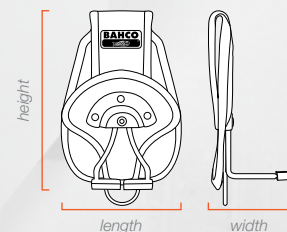

4750-MPH-1
MULTI PURPOSE HOLDER

- Riveted for truly unbreakable strength. Measuring tape clip for any common builder's tape measure from 3 to 10 meters long
- Made of strong 1680 denier polyester
- Extra leather slot in the middle for a pen or a small screwdriver
- Ideal item to be added to your own creation of Tool Belt Set together with other products
- Leather slots ideal for holding different types of tools i.e. knives, screwdrivers



	METRIC
height	240 mm
length	170 mm
width	60 mm
weight	0,220 kg
volume	0 l

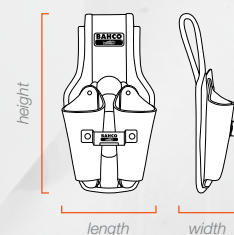

4750-UP-1 UNIVERSAL POUCH

- Fits any BAHCO tool belt or normal clothing belt
- Useful while working with the hands up, when the quick access to tools is needed
- Made of strong 1680 denier polyester. Visible badge with BAHCO logo on the front of the holder. Swings to keep your hammer at a comfortable angle
- Solution with side gate lets you easily put the tool in without looking at the holder
- Keeps all kinds of common hammers used on building site



	METRIC
height	260 mm
length	290 mm
width	180 mm
weight	0.550 kg
volume	2,000 l

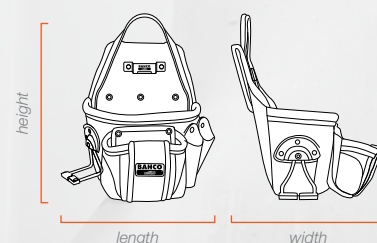

4750-2PP-1
TWO POCKET FIXINGS POUCH

- Perfectly positioned wide pockets hold plenty of fixings and provide quick tool recognition. Fits any BAHCO tool belt or normal clothing belt
- Necessary equipment is at hand when needed. Made of strong 1680 denier polyester
- General shape with rigid pocket sides designed to keep the pouch
- Stable and vertical, preventing tools and fixings from falling out



	METRIC
height	260 mm
length	260 mm
width	180 mm
weight	0.370 kg
volume	2,000 l

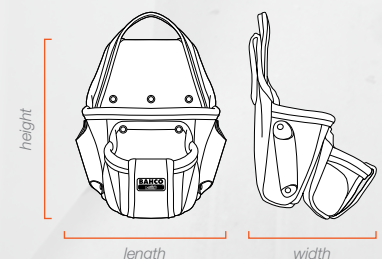

4750-VMPH-1
VERTICAL SMARTPHONE HOLDER

- Closed by VELCRO for greater security
- Made of strong 1680 denier polyester
- Fits any belt from the Collection
- Works also without the belt
- Universal mobile phone holder with a flap for extra protection on a building site



	METRIC
height	160 mm
length	100 mm
width	35 mm
weight	0.080 kg
volume	0.120 l

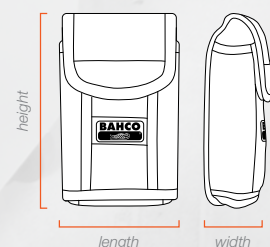

4750-KNHO-0 / 4750-KNHO-1 KNIFE HOLDER

- Finished with an extra layer of suede leather to ensure resistance to years of wear and tear
- Necessary equipment is at hand when needed
- Riveted for truly unbreakable strength
- Made of strong 1680 denier polyester
- Fits any belt from the Collection
- Unique shape of this holder specifically designed to suit the utility knives

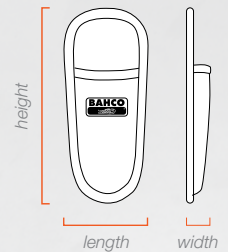
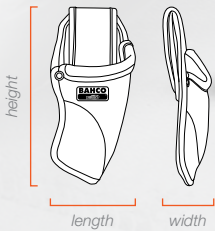

4750-KNHO-1

	METRIC
height	200 mm
length	100 mm
width	50 mm
weight	0,090 kg
volume	0,100 l

4750-KNHO-0

	METRIC
height	210 mm
length	85 mm
width	20 mm
weight	0,080 kg
volume	0,080 l

4750-HDB-2

HEAVY DUTY BELT WITH CUSHION

- Features a Heavy Duty Leather Belt with stainless steel twin-pin buckle
- Made of strong 1680 danier polyester with polyethylene backing
- Riveted for truly unbreakable strength



	METRIC
height	190 mm
length	900 mm
width	50 mm
weight	0.650 kg
volume	0.250 l

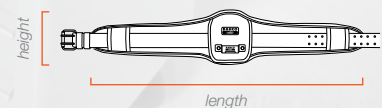

■ **4750-QRFB-1**

QUICK RELEASE FABRIC ADJUSTABLE BELT

4750-HDLB-1

HEAVY DUTY LEATHER BELT

- Simple design and flexibility of the belts helps in easy using
- Our belts are made of the high quality materials such as high grade leather or 1680 denier polyester
- Our belts are design in the universal sizes so they fit any weight

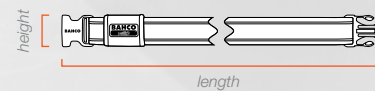

4750-QRFB-1

	METRIC
height	50 mm
length	1200 mm
width	0 mm
weight	0,310 kg
volume	0 l

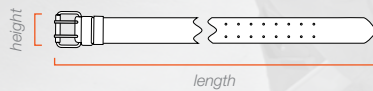

4750-HDLB-1

	METRIC
height	50 mm
length	1290 mm
width	0 mm
weight	0,300 kg
volume	0 l



4750-KP-1
ANTI SLIP KNEE PADS

- Universal lightweight knee pads for different kinds of surfaces
- Heavy Duty rubber cups ensure comfort and safety when used in difficult conditions
- Elastic straps with hook-and-loop fasteners for easy adjustment to leg sizes
- Breathable 3D Air Mesh material lining provides maximum cushioning for all day of wearing
- Made from rubber and polyester 1680 denier ideal for most applications including general construction, use on uneven surfaces and for laying carpets, floor tiles and flooring etc.



	METRIC
height	160 mm
length	220 mm
width	70 mm
weight	0.300 kg
volume	0 l



■ 4750PTB50 / 4750PTB60

PLASTIC TOOL BOXES

- Made of virgin polypropylene (PP) :
- Makes the box Heavy Duty even if used under extreme conditions
- Low and high temperatures resistance: -20C° / +50C°
- Load dynamic capacity: 20kg & 22kg
- Load static capacity: 120kg & 130kg
- Internal tray
- External box dividers
- Aluminum long handle:
 - Locking system
 - Easy transportation
- Padlockable
- Metallic latches and galvanized key components:
 - Resistant to the rust and long lasting



4750PTB50



4750PTB60

	DIMENSIONS	CAPACITY	LOAD CAPACITY	WEIGHT
4750PTB50	500x295x270	27 l.	20	2,4 kg
4750PTB60	600x305x295	37 l.	22	3,2 kg

4750PTBW47

PLASTIC TOOL BOXES



ERGO TOOL MANAGEMENT SYSTEM

- Made of virgin polypropylene (PP):
 Makes the box Heavy Duty even if used under extreme conditions
 Low and high temperatures resistance: -20C°/ +50C°
 Load dynamic capacity: 25kg
 Load static capacity: this tower box is not intend to be used as a step
- External box dividers
- Upper box
 - Internal tray
 - Padlockable
 - Foldable handle- big grey color
- Metallic latches and galvanized key components
- Wheels: 135x37mm
 - Hub made in polypropylene plastic with a single galvanized axel
 - External wheel EVA material for a smooth and silent rolling



4750PTBW47



	DIMENSIONS	CAPACITY	LOAD CAPACITY	WEIGHT
4750PTBW47	470x290x630	60 l.	25	4,21 kg